

**ADOPTED  
ANNUAL BUDGET  
2016-2017**



**MAYOR**

Harry E. Rediger

**CITY COUNCIL**

Joseph Uzoaru

Shelly Moore

Victor R. Gunn

Robbie Guard

Bob Fox

Wayne Bowen

**2016-2017 ANNUAL BUDGET  
TABLE OF CONTENTS**

	<u>Page</u>
<b>City Manager's Budget Message .....</b>	<b>I-IX</b>
 <b>Summary of Programs by Department</b>	
Summary by Program .....	3
Administrative Services .....	4
Development Services .....	5
Parks & Recreation .....	6
Public Safety .....	7
Public Works .....	8
Internal Services.....	9
 <b>Summary of Revenue and Expenses by Fund and Fund Types Combined Statement of Revenues, Expenditures, and Changes in Fund Balance-(With Charts)</b>	
Total Budget.....	12-13
Governmental Funds.....	14-15
Proprietary Funds.....	16-17
All Funds Revenue-Budget by Fund.....	18
All Funds Expense-Budget by Fund .....	19
 <b>General Fund</b>	
Budget Highlights .....	21-24
General Fund Pie Charts .....	25
General Fund Income Statement.....	26-27
General Fund Revenue.....	28-29
General Fund Expenditures by Division-Summary .....	31
City Council .....	32-33
City Manager.....	34-35
Public Awareness.....	36-37
City Attorney.....	38-39
Human Resources .....	40-41
Finance .....	42-43
Municipal Court.....	44-45
Facility Maintenance.....	46-47
Planning Services.....	48-49
Inspection Services .....	50-51
Engineering .....	52-53

General Fund Expenditures by Division (Cont.)

Police .....	54-55
Fire .....	56-57
Street .....	58-59
Park Maintenance.....	60-61
Cemetery .....	62-63
Interdepartmental Services.....	64
Contingency .....	65

**Special Revenue Funds**

Budget Highlights .....	67
Special Revenue Pie Charts .....	69
Special Revenue Income Statement.....	70

Special Revenue Expenditures by Fund

Airport .....	71-78
Parks & Recreation .....	79-94
Health .....	95-102
Convention/Visitors Bureau.....	103-110
Downtown Business District.....	111-116
Public Safety Trust Fund.....	117-122
Public Safety Trust Fund II.....	123-128
Casino Revenue Fund .....	129-134
Riverfront Region Economic Development.....	135-140
Housing Development Grants.....	141-146
Motor Fuel Tax .....	147-154
Transportation Sales Tax Trust Fund.....	155-160
Transportation Sales Tax Trust Fund II .....	161-166
Transportation Sales Tax Trust Fund III.....	167-172
Transportation Sales Tax Trust Fund IV.....	173-179
Transportation Sales Tax Trust Fund V.....	180-185
Capital Improvement Sales Tax - Water Projects.....	186-193
Capital Improvement Sales Tax – Sewer System Improvements .....	194-199
Fire Sales Tax Fund .....	200-205
Parks/Stormwater Sales Tax – Capital.....	206-213
Parks/Stormwater Sales Tax – Operations.....	214-221

**Debt Service Fund**

Budget Highlights .....	222
General Long-Term Bonds .....	224-227

## Capital Projects Funds

Budget Highlights .....	228
Capital Projects Income Statement .....	229
Capital Projects Expenditures by Fund	
General Capital Improvement .....	230-235
Street Improvement.....	236-241
Park Improvement .....	242-247
Surface Transportation Program – Urban Projects .....	248-253
Community Development Block Grant .....	254-259

## Enterprise Funds

Budget Highlights .....	260
Enterprise Funds Pie Charts.....	262
Enterprise Funds Income Statement .....	263
Enterprise Funds Expense by Fund	
Sewer .....	264-281
Water .....	282-289
Solid Waste .....	290-305
Golf Course.....	306-317
Sports Complexes .....	318-325

## Internal Service Funds

Budget Highlights .....	326
Internal Service Pie Charts.....	328
Internal Service Fund Income Statement .....	329
Internal Service Expense by Fund	
Information Technology.....	330-335
Fleet Management.....	336-341
Employee Benefits Fund .....	342-345
Risk Management .....	346-349
Equipment Replacement .....	350-353

## Appendices

City of Cape Girardeau Organizational Chart.....	354
Special Projects .....	355-356
Capital Projects .....	358-360
Authorized Positions Summary .....	361-362
Grade/Salary Range Schedule .....	364
Tax Rate Analysis .....	365
Assessed Valuation of Taxable Property .....	366
What Does a City Property Owner Pay? .....	367
Debt Service Statements .....	368-383
Inspection Service Fee Schedule .....	384-387

# BUDGET MESSAGE

*Office of the City Manager*

## INTRODUCTION

In accordance with Article VI of the City Charter, the City Council adopted the following budget for the City of Cape Girardeau, Missouri, for the period from July 1, 2016 to June 30, 2017. The adopted budget is balanced within the total of estimated income plus unencumbered fund balances.

This budget provides the financial plan for the various City departments to deliver services to the citizens of the City and provide infrastructure for future City development. The various departments funded under this budget are organized by department as set out in the administration ordinance of the City. These departments include Administrative Services, Development Services, Parks and Recreation, Public Safety, and Public Works. Outside of these Departments are the following budget categories: Debt Service and Capital Improvement Program (governmental fund types only) and Contingency. Internal Service Funds (funds that provide and charge for service to other city programs) are not included in the above categories to avoid reporting costs twice. A summary of the City's Budget by department is included on page 3 of this Budget.

The Administrative Services Department administers the fiscal affairs and personnel policies and provides legal counsel and representation. The Municipal Court is also reported in this department. This budget authorizes 27 full time and 28.43 full time equivalent employees (FTE) for this department. Its operating budget is \$2,683,106.

The Development Service Department coordinates activities pertaining to community and economic development. This budget authorizes 41 full time and 45.72 (FTE) for this department. Its operating budget is \$5,626,052

The Parks and Recreation Department is responsible for the care and upkeep of the 26 city parks totaling around 665 acres, maintaining recreation facilities and buildings, and supervising a city recreation program. This budget authorizes 52 full time and 116.88 (FTE) for this department. Its operating budget is \$6,022,918.

The Public Safety Department is responsible for protecting life and property through the enforcement of state and city ordinances, fire and crime prevention activities, and emergency response. Its service area is approximately 28.4 square miles and is responsible for protecting approximately 36,000 citizens and a total day-time population of approximately 100,000 people. This budget authorizes 179 full time and 180.94 (FTE) for this department. Its operating budget is \$14,298,433.

## **INTRODUCTION (Cont.)**

The Public Works Department is responsible for the care and maintenance of the city streets and sidewalks, the operation and maintenance of the city's water and sewer systems, the operation of city's solid waste disposal service, and maintenance of the city's storm water systems. This department currently maintains 223 linear miles of streets, 256 linear miles of water lines, and 225 linear miles of sanitary sewer lines. This budget authorizes 85 full time and 85.95 (FTE) for this department. Its operating budget is \$23,876,569.

The total budget authorizes 399 full time and 474.02 (FTE) with a total operating budget of \$58,472,848. The budget also authorizes an additional \$31,867,240 in capital outlays.

### **Budget Hearing Requirements**

The City Council, in accordance with Article VI of the City Charter held a public hearing regarding this budget on Monday, June 6, 2016 and approved a budget ordinance at its meetings on June 6 and June 20, 2016.

Another public hearing will be required in conjunction with the adoption of the tax levy. The state law requires the County Clerk to certify to the City, by July 1 of each year, the assessment information on which the City can calculate its actual tax levy. Once this information has been provided to the City, the City Council must hold a public hearing after adequate notice has been published, and at that time (normally first meeting in August), the City Council formally adopts the tax levy for the City of Cape Girardeau.

## **BUDGETARY ACCOUNTING BASIS**

All financial data included in this budget reflect the modified accrual method of accounting. Under the modified accrual method capital purchases, bond issuance costs, and bond principal repayments are reflected as expenses when made and bond proceeds, grants for capital projects, special tax assessments, and sewer connections fees are treated as revenue when received.

## **PROGRAM BUDGETS**

A summary of the program budgets is included on page 3 of this budget. A more detailed breakdown of the programs by departments is included in pages 4 – 9. Total operating expenditures for all programs excluding Internal Service Funds is \$58,472,848. This is a total increase of \$4,234,423 or 7.81% more than the prior year's original adopted budget. This change is made up of increases in personnel, operating, and debt service costs which increased \$720,372 or 2.81%, \$974,249 or 3.83%, and \$2,539,802 or 80.93%, respectively over the prior year's budget.

## PROGRAM BUDGETS (Cont.)

This budget includes a July 1, 2016 2.0% wage increase for all City full-time employees and part-time employees hired before January 1, 2016 at total costs of approximately \$402,000 and \$27,000, respectively.

LAGERS (the employees' retirement system) was able to reduce the rates that it charges the City because of positive financial results during the past several years. This resulted in savings of approximately \$115,000 or .71% from the previous year's budget.

This budget also reflects an additional \$69,481 cost for employee health coverage. Coverage for the four additional employees included in this budget accounts for \$27,591 of this increase. The net cost only increased \$41,890 or 1.56% from the previous year's budget. Actual rates charged are based on 100% of expected claims.

This budget also includes the following:

A deputy city manager position was added during the current year at a cost of \$122,396.

Three grant funded police officer positions were added during the current year at a cost of \$157,329. Seventy-five per cent of these costs will be grant funded for three years.

This budget includes the addition of a recreation coordinator position to be shared by recreation and sports complexes divisions at a total cost of \$48,225. A reduction of part-time intern and concession manager hours (.423 FTE) will fund \$9,187 of this cost. The remainder of the cost will be funded from the Parks / Stormwater Sales Tax – Operating Fund.

A solid waste position was eliminated during the current year resulting in savings of approximately \$40,000. During the current year the City eliminated its Lugerger service.

This budget includes an additional \$55,000 to the fire overtime allowance at a total cost of \$67,745. This would increase the allowance to actual results from the previous 2 years.

This budget includes \$40,000 for adjustment to public safety salaries to solve pay plan inequities that have developed over previous years and \$19,000 for new and increased public safety specialty pay at a total cost of \$71,725.

An allowance for additional part-time hours (.75 FTE) with an estimated cost of \$17,814 is included for the airport fund. This addition would correct errors reflected in previous budgets.

This budget includes additional part-time personal trainer hours (.72 FTE) with an estimated cost of \$33,084. These costs will be funded by additional training fees.

An allowance for additional part-time hours at Cape Splash (.615 FTE) with an estimated cost of \$13,858 is included in this budget. This extra cost will be paid from the Parks / Stormwater Sales Tax – Operating Fund.

## PROGRAM BUDGETS (Cont.)

A contingent expenditure totaling \$120,000 to cover potential extra police and fire personnel costs was continued during the year. An additional one-time contingent expenditure totaling \$31,782 for temporary administrative help is included in this budget.

This budget includes \$5,678,228 for non-enterprise fund debt service. This was \$2,539,802 or 80.93% more than the previous budget. During the current year debt was issued to fund the construction of an indoor sports complex, a new police headquarters, replacement of a fire station, upgrades of two fire stations, replacement of 5 fire trucks, the replacement of a bridge on South Sprigg Street, and a bond refinancing. As a result, Debt service increased \$2,619,094.

This budget includes \$26,413,822 for non-personnel operating expenses. This was \$974,249 or 3.83% more than the previous budget. Enterprise funds' debt service payments are treated as operating expenses in the program budget summaries and increased \$307,584 or 3.68% in this budget. Excluding these payments non-personnel operating expense included in this budget were \$666,655 or 3.90% more than the previous budget.

The following are notable changes in non-personnel operating expenses included in this budget:

This budget includes \$23,255 or 3.1% less for administrative expense than the previous year. The previous budget allowed \$27,500 for one-time election and education expenses. This budget includes nothing for these expenses.

This budget includes \$100,000 in adverting costs for the airport that are related to an air service grant which will pay 90% of the costs. Runway repair and maintenance costs included in this budget are \$40,000 or 57.14% less than the previous budget. Building repair and maintenance costs included in this budget are \$17,500 or 63.64% more than the previous budget.

This budget proposes \$576,200 for payments on various development agreements which is \$71,200 or 14.1% more than the previous budget. Over 99% of the payments will be paid out of special purpose sales tax revenues.

This budget includes \$180,444, \$99,964, \$31,320, and \$28,000 in the police division for fleet maintenance costs, vehicle insurance, employee uniform costs, and specialized training cost. These are \$17,046 or 10.43%, \$12,566 or 14.43%, \$5,000 or 19.00%, and \$7,700 or 37.93% more, respectively, than the previous budget.

This budget includes \$12,564, and \$26,015 in the fire division for payments to the equipment replacement fund and vehicle insurance costs. These are \$9,647 or 43.43% and \$9,208 or 26.14% less, respectively, than the previous budget.

This budget includes \$132,207 for the demolition of dangerous buildings from the Health Fund. This was an increase of \$17,173 or 14.93% from the previous budget.

The street division's budget includes \$200,000 for snow and ice removal supplies. This is \$50,000 or 20% less than the previous budget.



## **PROGRAM BUDGETS (Cont.)**

This budget includes \$940,340, \$425,712, and \$137,786 for contract disposal costs, fleet maintenance costs, and vehicle fuel costs in the solid waste fund. The contract disposal costs and fleet maintenance costs are 84,644 or 9.89% and \$34,260 or 8.75% more than the previous budget. Vehicle fuel costs are \$33,516 or 19.57% less than the previous budget.

This budget includes \$150,000, and \$52,000 in the water fund for meter replacements and building repair and maintenance. These are \$130,000 or 46.43% less and \$30,000 or 136.36% more, respectively, than the previous budget.

This budget establishes annual allowances of \$60,000 and \$20,000 in the sewer fund for lift station repairs and engineering services, respectively. It also includes \$162,000 for disposal of bio-solids as a result of the drying process not being fully operational at the plant. It was anticipated that this process would be operational when the plant opened and nothing was included in the previous budget for bio-solid disposal.

This budget also includes \$425,387, \$54,700, and \$59,395 for utility costs, building and contents insurance, vehicle fuel costs in the sewer fund. The utility costs and insurance costs are 115,844 or 37.42% and \$42,864 or 362.15% more than the previous budget. Vehicle fuel costs are \$74,667 or 55.70% less than the previous budget. These changes were made to reflect operating expenses incurred during the first full year of operating the new sewer plant. Additionally this budget also commits an additional \$29,300 or 78.08% to small equipment purchases.

This year budget includes payments of \$654,800 and \$2,392,963 to Cape Girardeau Chamber of Commerce and Alliance Water Resources, respectively, for operation of the Convention and Visitors Bureau and the City's water system. In the previous budget these payments were \$645,200 and \$2,334,598.

The Casino Riverfront Development Fund allocated \$114,000 in this budget to be used to fund operating expenses of Old Town Cape. The previous budget allocated \$111,000.

Total capital expenditures for all programs excluding Internal Service Funds are \$31,867,270. This is a total increase of \$6,753,651 or 26.89% from the previous year's budget.

## **GENERAL FUND REVENUES**

The General Fund is almost totally supported by general taxes and accounts for the basic municipal functions of police, fire, street maintenance, parks maintenance, etc. In addition, this fund is used to finance temporary cash flow shortfalls in other funds, to provide a contingency account, to provide operating transfers to the parks and recreation, airport, and softball complex funds, and to meet special project needs for economic development and other purposes approved by the City Council.

**GENERAL FUND REVENUES (Cont.)**

The revenue for this fund excluding pass through transfers is projected to be derived as follows:

<u>SOURCE</u>	<u>AMOUNT</u>	<u>% OF TOTAL FUND</u>	<u>% CHANGE</u>
Property Taxes	\$1,911,235	7.5%	2.3%
Sales Tax	10,695,600	42.1%	2.4%
Franchise Tax	4,777,470	18.8%	-3.4%
Cigarette Tax	165,000	0.7%	-3.7%
Licenses & Permits	1,636,494	6.4%	.5%
Intergovernmental	639,734	2.5%	26.7%
Service Charges	263,700	1.0%	17.8%
Fines & Forfeitures	695,650	2.7%	-11.4%
Interest	71,870	0.3%	3.6%
Miscellaneous	461,424	1.8%	8.9%
Internal Service Charges	1,001,471	4.0%	.9%
Motor Fuel Tax Transfer Public Safety Trust	1,445,000	5.7%	1.8%
Transfer (Sales Tax)	1,294,115	5.1%	3.4%
Other Transfers	342,817	1.4%	16.4%
<b>TOTAL</b>	<b><u>\$25,401,580</u></b>	<b><u>100.0%</u></b>	<b><u>1.5%</u></b>

Sales Tax represents 47.2% of the total General Fund budget; therefore, the assumptions of growth in this revenue can have a significant impact on the amount of funds projected to be available for payroll, equipment, and capital improvement projects. Each 1% change in the sales tax receipts equals approximately \$120,000 in revenue. For this budget, sales tax is projected to be 5.28% above the actual revenue for the fiscal year ending June 30, 2015. Sales tax is currently projected to grow 3.22% during the current year.

Franchise Taxes represent 18.8% of the total General Fund budget. Each 1% change in franchise tax receipts equals approximately \$48,000 in revenue. Franchise Taxes projected for this budget are \$167,600 or 3.4% less than those projected in the prior year's budget. Franchise taxes from the City's natural gas and electricity provider is projected to decrease \$173,100 or 4.9% based mainly on lower electricity and natural gas rates that were in effect in the previous year and average city-wide utility usage during the past three years. Franchise Taxes from the remaining providers are projected to be \$5,500 or .4% more than the prior year in this budget.

## **GENERAL FUND REVENUES (Cont.)**

The property tax, which is the next most important revenue source, only represents 7.5% of the General Fund. Each 1% change in the assessed valuations of property will equal approximately \$19,000 in revenue. Each \$0.01 change in the property tax levy will equal approximately \$63,000 in revenue. Assessed valuation is assumed to grow 1.5% and 3.0% for real estate and personal property taxes, respectively. No tax levy increase is assumed in this budget.

## **USER CHARGES**

Projected sewer, water, and solid waste revenues included in this budget are based on the estimated number of June 30, 2016 customers and their projected usage for the current and previous year and assumed rate increases for the sewer, water and solid waste charges. Residential and commercial charges will increase 2% and 3% for sewer and water, respectively, with the first billing in July. Monthly residential solid waste and recycling collection charges will increase to \$19.75 from \$19.25 with the first billing in July. The per ton tipping fee at the transfer station is will increase to \$59.00 from \$57.50 on July 1.

This budget also proposes changes to the City's Inspection Service Fee Schedule and certain recreation fee increases. The proposed fee schedule is shown on pages 384 – 387. Details of the proposed recreation fee increases are detailed on page 81. As new activities arise during the year, user fees may be charged to offset operating costs.

## **PAYROLL**

A summary of the number of authorized positions by department by year is included in pages 361 - 362 of the appendices. The total payroll for all operations, including all fringe benefits, is \$26,377,642. This is 45.1% of the total operating expenditures and reflects a 2.80% increase over the current budget. In the current year payroll represents 47.3% of the total operating budget. This budget assumes a city-wide 2.0% salary increase for its employees effective the first payroll in July.

## **DEBT SERVICE**

A summary of the city's outstanding bonded debt and its anticipated sources of repayment are included along with detailed schedules of debt service requirements in pages 368 – 383 of the appendices. Total debt service payments during the coming fiscal year will be \$14,341,956 which includes an anticipated \$61,643 to be repaid to the General Fund for loans to other city funds. All debt service is paid from specific revenue sources designated for that purpose in this budget.

## CAPITAL IMPROVEMENTS

A complete list of capital improvement program appropriations is included in pages 358 - 360 of the appendices of this budget document. These expenditures total \$29,751,300 and will result in the accomplishment of all but a few of the projects (or phases of projects) as set out in the transportation and environment sections for the first year of the current Five Year Capital Improvement Program recently adopted by the City Council. Certain airport projects were not included. They will be appropriated as the related grants are awarded. The Nash Road/Airport Sanitary Sewer Study was not included. The study will be appropriated when a funding agreement is developed and accepted by all benefitting parties.

A parks / storm water sales tax was passed in April 2008 and will provide funding for the parks and storm water projects included in the Five Year Capital Improvement Program. However, these projects have not been included in this budget but are included in a project length budget.

## CONCLUSION

In preparing the annual operating budget, the City Staff has had the opportunity to review and revise current services with the goal of achieving greater efficiency and effectiveness in the delivery of municipal services. A number of key decisions relative to revenue assumptions, fees, equipment, capital improvement, and payroll are represented in the adoption of the City Budget. We feel this annual financial plan will provide the citizens of this community a quality level of municipal services that is within available revenues.

Since 2004 the Fire Sales Tax has allowed the City to make great strides in equipping the Fire and Police Departments. This tax was renewed in November 2014 and will not expire until December 2035. This renewal will also allow the City to address the most pressing facility needs of the Fire and Police Departments.

In April 2008, the citizens passed a Parks / Storm Water Sales Tax. This has allowed the City to make progress in equipping and providing personnel for the various park divisions and to complete significant park and storm water projects that had been unfunded for several years.

However, after funding required contributions to emergency reserves, the general fund still produces little to no operating margins to fund the rest of its equipment, personnel, and capital projects needs. During the current year there was no general fund operating margin available for equipment and other capital expenditures. The lack of operating margin in the general fund also reduces our ability to withstand future economic downturns.

Projected General Fund results for the next five years are shown on page 27. These projections include operating expenses growing at the rate of inflation and no annual expenditures for capital outlays. During the five year projection period sales tax revenue must grow at 1.00% above the rate of inflation to maintain a constant unreserved fund balance. During the past ten years City's sales tax revenue has averaged growing 2.30% annually while annual inflation has averaged 2.16%. The growth of sales tax revenue was 1.0% above inflation in only 3 of the past 10 years. The City will be challenged to meet its operating and capital equipment needs in the future with its current revenue and expense structure.

CONCLUSION(cont.)

Its projected that the City's general fund unreserved fund balance will decline during the current year to around \$2,434,259 or approximately 8.2% of 2016 – 2017 proposed operating expenditures of funds traditionally supported by the general fund. This estimated fund balance combined with what hopefully will be an improving economy may allow the City to meet some of its future capital needs while providing a cushion to withstand future economic downturns.

Respectfully submitted,

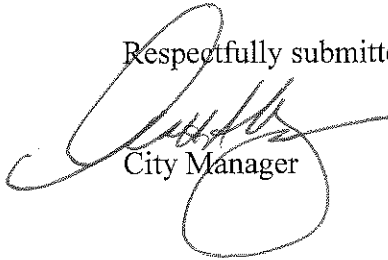

City Manager



John Richbary  
Finance Director

SAM:JRR:bt

---

**SUMMARY  
OF  
PROGRAMS  
BY  
DEPARTMENT**

---

THIS PAGE INTENTIONALLY LEFT BLANK

---

SUMMARY BY PROGRAM \*

**OPERATING EXPENDITURES**

PROGRAM/SERVICE	2015-2016 BUDGET	2016-2017 BUDGET	% CHANGE	PROGRAM INCOME
ADMINISTRATIVE SERVICES	\$2,550,621	\$2,683,106	5.19%	\$1,043,862
DEVELOPMENT SERVICES	5,414,852	5,626,052	3.90%	2,692,673
PARKS AND RECREATION	5,924,595	6,022,918	1.66%	2,529,591
PUBLIC SAFETY	13,847,604	14,298,433	3.26%	987,446
PUBLIC WORKS	23,112,673	23,876,569	3.31%	17,541,642
CAPITAL IMPROVEMENTS	-	-	0.00%	
DEBT SERVICE	3,138,426	5,678,228	80.93%	
CONTINGENCY	249,654	287,542	15.18%	
<b>TOTAL OPERATING EXPENDITURES</b>	<b>\$54,238,425</b>	<b>\$58,472,848</b>	<b>7.81%</b>	<b>\$24,795,214</b>

**CAPITAL OUTLAY**

PROGRAM/SERVICE	2015-2016 BUDGET	2016-2017 BUDGET	% CHANGE
ADMINISTRATIVE SERVICES	\$ -	\$ -	0.00%
DEVELOPMENT SERVICES	1,318,025	861,000	-34.67%
PARKS AND RECREATION	274,500	655,000	138.62%
PUBLIC SAFETY	86,256	254,286	194.80%
PUBLIC WORKS	8,775,500	3,513,877	-59.96%
CAPITAL IMPROVEMENTS	14,659,338	26,583,107	81.34%
DEBT SERVICE	-	-	0.00%
CONTINGENCY	-	-	0.00%
<b>TOTAL CAPITAL OUTLAY</b>	<b>\$ 25,113,619</b>	<b>\$31,867,270</b>	<b>26.89%</b>

**TOTAL EXPENDITURES**

PROGRAM/SERVICE	2015-2016 BUDGET	2016-2017 BUDGET	% CHANGE	PROGRAM INCOME
ADMINISTRATIVE SERVICES	\$2,550,621	\$2,683,106	5.19%	\$1,043,862
DEVELOPMENT SERVICES	6,732,877	6,487,052	-3.65%	2,692,673
PARKS AND RECREATION	6,199,095	6,677,918	7.72%	2,529,591
PUBLIC SAFETY	13,933,860	14,552,719	4.44%	987,446
PUBLIC WORKS	31,888,173	27,390,446	-14.10%	17,541,642
CAPITAL IMPROVEMENTS	14,659,338	26,583,107	81.34%	
DEBT SERVICE	3,138,426	5,678,228	80.93%	
CONTINGENCY	249,654	287,542	15.18%	
<b>GRAND TOTAL</b>	<b>\$79,352,044</b>	<b>\$90,340,118</b>	<b>13.85%</b>	<b>\$24,795,214</b>

\* Excludes Internal Service Funds.



ADMINISTRATIVE SERVICES

**OPERATING EXPENDITURES**

PROGRAM/SERVICE	2015-2016 BUDGET	2016-2017 BUDGET	% CHANGE	PROGRAM INCOME
CITY COUNCIL	\$89,989	\$26,710	-61.84%	
CITY MANAGER	353,925	480,246	35.69%	
CITY ATTORNEY	317,085	327,570	3.31%	
HUMAN RESOURCES	337,451	341,252	1.13%	
FINANCE	618,408	627,608	1.49%	
MUNICIPAL COURT	320,635	328,123	2.34%	65,000
FACILITY MAINTENANCE	230,501	225,555	-2.15%	
PUBLIC AWARENESS	147,792	164,790	11.50%	
INTERDEPARTMENTAL	154,835	161,252	4.14%	978,862
<b>TOTAL OPERATING EXPENDITURES</b>	<b>\$2,550,621</b>	<b>\$2,683,106</b>	<b>5.19%</b>	<b>\$1,043,862</b>

**CAPITAL OUTLAY**

PROGRAM/SERVICE	2015-2016 BUDGET	2016-2017 BUDGET	% CHANGE
CITY COUNCIL	\$ -	\$ -	0.00%
CITY MANAGER	-	-	0.00%
CITY ATTORNEY	-	-	0.00%
HUMAN RESOURCES	-	-	0.00%
FINANCE	-	-	0.00%
MUNICIPAL COURT	-	-	0.00%
FACILITY MAINTENANCE	-	-	0.00%
PUBLIC AWARENESS	-	-	0.00%
INTERDEPARTMENTAL	-	-	0.00%
<b>TOTAL CAPITAL OUTLAY</b>	<b>\$ -</b>	<b>\$ -</b>	<b>0.00%</b>

**TOTAL EXPENDITURES**

PROGRAM/SERVICE	PAGE NUMBER	2015-2016 BUDGET	2016-2017 BUDGET	% CHANGE	PROGRAM INCOME
CITY COUNCIL	33	\$69,989	\$26,710	-61.84%	
CITY MANAGER	35	353,925	480,246	35.69%	
CITY ATTORNEY	39	317,085	327,570	3.31%	
HUMAN RESOURCES	41	337,451	341,252	1.13%	
FINANCE	43	618,408	627,608	1.49%	
MUNICIPAL COURT	45	320,635	328,123	2.34%	65,000
FACILITY MAINTENANCE	47	230,501	225,555	-2.15%	
PUBLIC AWARENESS	37	147,792	164,790	11.50%	
INTERDEPARTMENTAL	64	154,835	161,252	4.14%	978,862
<b>GRAND TOTAL</b>		<b>\$2,550,621</b>	<b>\$2,683,106</b>	<b>5.19%</b>	<b>\$1,043,862</b>

DEVELOPMENT SERVICES

**OPERATING EXPENDITURES**

PROGRAM/SERVICE	2015-2016 BUDGET	2016-2017 BUDGET	% CHANGE	PROGRAM INCOME
PLANNING	\$464,840	\$494,205	6.32%	9,600
INSPECTION	544,245	546,722	0.46%	311,985
ENGINEERING	1,176,439	1,185,037	0.73%	17,500
AIRPORT				
OPERATIONS	953,982	1,045,389	9.58%	1,954,630
FBO OPERATION	422,896	419,949	-0.70%	371,708
TOTAL AIRPORT	<u>\$1,376,878</u>	<u>\$1,465,338</u>	<u>6.42%</u>	
C/V BUREAU	713,080	\$704,800	-1.16%	
DOWNTOWN BUS DISTRICT	27,430	27,250	-0.66%	27,250
COMMUNITY DEVELOPMENT	210,000	205,000	-2.38%	
ECONOMIC DEVELOPMENT	789,440	885,200	12.13%	
UNITED WAY	2,500	2,500	0.00%	
PUBLIC TRANSPORTATION	110,000	110,000	0.00%	
TOTAL OPERATING EXPENDITURES	<u>\$5,414,852</u>	<u>\$5,626,052</u>	<u>3.90%</u>	<u>\$2,692,673</u>

**CAPITAL OUTLAY**

PROGRAM/SERVICE	2015-2016 BUDGET	2016-2017 BUDGET	% CHANGE
PLANNING	\$ -	\$ -	0.00%
INSPECTION	-	-	0.00%
ENGINEERING	-	-	0.00%
AIRPORT			
OPERATIONS	50,000	861,000	1622.00%
FBO OPERATIONS	-	-	0.00%
TOTAL AIRPORT	<u>\$ 50,000</u>	<u>\$ 861,000</u>	<u>1622.00%</u>
C/V BUREAU	1,268,025	-	-100.00%
DOWNTOWN BUS DISTRICT	-	-	0.00%
COMMUNITY DEVELOPMENT	-	-	0.00%
ECONOMIC DEVELOPMENT	-	-	0.00%
UNITED WAY	-	-	0.00%
PUBLIC TRANSPORTATION	-	-	0.00%
TOTAL CAPITAL OUTLAY	<u>\$ 1,318,025</u>	<u>\$ 861,000</u>	<u>-34.67%</u>

**TOTAL EXPENDITURES**

PROGRAM/SERVICE	PAGE NUMBER	2015-2016 BUDGET	2016-2017 BUDGET	% CHANGE	PROGRAM INCOME
PLANNING	49	\$464,840	\$494,205	6.32%	\$9,600
INSPECTION	51	544,245	546,722	0.46%	311,985
ENGINEERING	53	1,176,439	1,185,037	0.73%	17,500
AIRPORT					
OPERATIONS	77	1,003,982	1,906,389	89.88%	
FBO OPERATIONS	78	422,896	419,949	-0.70%	
TOTAL AIRPORT		<u>1,426,878</u>	<u>2,326,338</u>	<u>63.04%</u>	
C/V BUREAU	109	1,981,105	704,800	-64.42%	
DOWNTOWN BUS DISTRICT	115	27,430	27,250	-0.66%	27,250
COMMUNITY DEVELOPMENT	64	210,000	205,000	-2.38%	
ECONOMIC DEVELOPMENT	64	789,440	885,200	12.13%	
UNITED WAY	64	2,500	2,500	0.00%	
PUBLIC TRANSPORTATION	64	110,000	110,000	0.00%	
GRAND TOTAL		<u>\$6,732,877</u>	<u>\$6,487,052</u>	<u>-3.65%</u>	<u>\$366,335</u>

PARKS AND RECREATION

**OPERATING EXPENDITURES**

PROGRAM/SERVICE	2015-2016 BUDGET	2016-2017 BUDGET	% CHANGE	PROGRAM INCOME
PARK MAINTENANCE	\$1,528,336	\$1,512,081	-1.06%	\$12,000
CEMETERY	190,379	193,318	1.54%	39,300
ARENA BUILDING MTNCE	264,168	256,721	-2.82%	50,000
OSAGE PARK COMMUNITY CENTER	538,231	557,359	3.55%	304,500
SHAWNEE PARK COMMUNITY CENTER	187,633	181,485	-3.28%	47,500
CENTRAL POOL	401,652	379,496	-5.52%	127,000
FAMILY AQUATIC CENTER	509,560	550,162	7.97%	676,200
RECREATION	629,446	676,157	7.42%	351,535
MUNICIPAL BAND	47,371	51,565	8.85%	
GOLF COURSE	627,174	614,184	-2.07%	514,200
SOFTBALL COMPLEX	1,000,645	1,050,390	4.97%	407,356
<b>TOTAL OPERATING EXPENDITURES</b>	<b>\$5,924,595</b>	<b>\$6,022,918</b>	<b>1.66%</b>	<b>\$2,529,591</b>

**CAPITAL OUTLAY**

PROGRAM/SERVICE	2015-2016 BUDGET	2016-2017 BUDGET	% CHANGE
PARK MAINTENANCE	\$ -	\$ -	0.00%
CEMETERY	-	-	0.00%
ARENA BUILDING MTNCE	-	10,000	100.00%
OSAGE PARK COMMUNITY CENTER	-	12,500	100.00%
SHAWNEE PARK COMMUNITY CENTER	-	-	0.00%
CENTRAL POOL	-	-	0.00%
FAMILY AQUATIC CENTER	-	-	0.00%
RECREATION	-	-	0.00%
MUNICIPAL BAND	-	-	0.00%
GOLF COURSE	-	-	0.00%
INDOOR SPORTS COMPLEX	-	-	0.00%
SOFTBALL COMPLEX	-	7,500	100.00%
<b>TOTAL CAPITAL OUTLAY</b>	<b>\$ -</b>	<b>\$ 30,000</b>	<b>100.00%</b>

**TOTAL EXPENDITURES**

PROGRAM/SERVICE	PAGE NUMBER	2015-2016 BUDGET	2016-2017 BUDGET	% CHANGE	PROGRAM INCOME
PARK MAINTENANCE	61	\$1,528,336	\$1,512,081	-1.06%	\$12,000
CEMETERY	63	190,379	193,318	1.54%	39,300
ARENA BUILDING MTNCE	87	264,168	266,721	0.97%	50,000
OSAGE PARK COMM CENTER	88	538,231	569,859	5.88%	304,500
SHAWNEE PARK COMM CTR	89	187,633	181,485	-3.28%	47,500
CENTRAL POOL	90	401,652	379,496	-5.52%	127,000
FAMILY AQUATIC CENTER	91	509,560	550,162	7.97%	676,200
RECREATION	92	629,446	676,157	7.42%	351,535
MUNICIPAL BAND	93	47,371	51,565	8.85%	
GOLF COURSE	307-315	627,174	614,184	-2.07%	514,200
SOFTBALL COMPLEX	319-323	1,000,645	1,057,890	5.72%	407,356
<b>GRAND TOTAL</b>		<b>\$5,924,595</b>	<b>\$6,052,918</b>	<b>2.17%</b>	<b>\$2,529,591</b>

PUBLIC SAFETY

**OPERATING EXPENDITURES**

<u>PROGRAM/SERVICE</u>	<u>2015-2016 BUDGET</u>	<u>2016-2017 BUDGET</u>	<u>% CHANGE</u>	<u>PROGRAM INCOME</u>
POLICE	\$7,987,220	8,377,974	4.89%	590,228
FIRE	5,392,887	5,446,241	0.99%	23,000
HEALTH	467,497	474,218	1.44%	374,218
TOTAL OPERATING EXPENDITURES	<u>\$13,847,604</u>	<u>\$14,298,433</u>	<u>3.26%</u>	<u>\$987,446</u>

**CAPITAL OUTLAY**

<u>PROGRAM/SERVICE</u>	<u>2015-2016 BUDGET</u>	<u>2016-2017 BUDGET</u>	<u>% CHANGE</u>
POLICE	\$ -	\$ -	0.00%
FIRE	-	-	0.00%
HEALTH	76,000	-	-100.00%
TOTAL CAPITAL OUTLAY	<u>\$ 76,000</u>	<u>\$ -</u>	<u>-100.00%</u>

**TOTAL EXPENDITURES**

<u>PROGRAM/SERVICE</u>	<u>PAGE NUMBER</u>	<u>2015-2016 BUDGET</u>	<u>2016-2017 BUDGET</u>	<u>% CHANGE</u>	<u>PROGRAM INCOME</u>
POLICE	55	\$7,987,220	\$8,377,974	4.89%	\$590,228
FIRE	57	5,392,887	5,446,241	0.99%	23,000
HEALTH	101	543,497	474,218	-12.75%	374,218
GRAND TOTAL		<u>\$13,923,604</u>	<u>\$14,298,433</u>	<u>2.69%</u>	<u>\$987,446</u>

PUBLIC WORKS

**OPERATING EXPENDITURES**

PROGRAM/SERVICE	2015-2016 BUDGET	2016-2017 BUDGET	% CHANGE	PROGRAM INCOME
STREET	\$2,855,519	\$2,787,835	-2.37%	
SOLID WASTE:				
TRANSFER STATION	1,149,997	1,433,162	24.62%	
RESIDENTIAL	1,369,686	1,361,667	-0.59%	
LANDFILL	3,125	3,114	-0.35%	
RECYCLING	690,791	713,779	3.33%	
TOTAL SOLID WASTE	\$3,213,599	\$3,511,722	9.28%	3,707,575
WATER	6,058,693	6,053,078	-0.09%	6,590,267
SEWER:				
STORMWATER	617,610	641,577	3.88%	
MAIN STREET LEVEES	80,321	100,585	25.23%	
SLUDGE DISPOSAL	478,143	580,503	21.41%	
PLANT OPERATIONS	8,946,137	9,353,394	4.55%	
LINE MAINTENANCE	862,651	847,875	-1.71%	
TOTAL SEWER	\$10,984,862	\$11,523,934	4.91%	7,243,800
TOTAL OPERATING EXPENDITURES	\$23,112,673	\$23,876,569	3.31%	\$17,541,642

**CAPITAL OUTLAY**

PROGRAM/SERVICE	2015-2016 BUDGET	2016-2017 BUDGET	% CHANGE
STREET	\$ -	\$ -	0.00%
SOLID WASTE:			
TRANSFER STATION	3,000	-	-100.00%
RESIDENTIAL	-	7,000	100.00%
LANDFILL	-	-	0.00%
RECYCLING	-	-	0.00%
TOTAL SOLID WASTE	\$3,000	\$7,000	133.33%
WATER	7,300,000	2,819,050	-61.38%
SEWER:			
STORMWATER	56,500	-	-100.00%
MAIN STREET LEVEES	-	-	0.00%
SLUDGE DISPOSAL	-	-	0.00%
PLANT OPERATIONS	342,000	687,827	101.12%
LINE MAINTENANCE	1,074,000	-	-100.00%
TOTAL SEWER	1,472,500	687,827	-53.29%
TOTAL CAPITAL OUTLAY	\$ 8,775,500	\$ 3,513,877	-59.96%

**TOTAL EXPENDITURES**

PROGRAM/SERVICE	PAGE NUMBER	2015-2016 BUDGET	2016-2017 BUDGET	% CHANGE	PROGRAM INCOME
STREET	59	\$2,855,519	\$2,787,835	-2.37%	
SOLID WASTE:					
TRANSFER STATION	298	1,152,997	1,433,162	24.30%	
RESIDENTIAL	300	1,369,686	1,368,667	-0.07%	
LANDFILL	302	3,125	3,114	-0.35%	
RECYCLING	304	690,791	713,779	3.33%	
TOTAL SOLID WASTE		\$3,216,599	\$3,511,722	9.39%	3,707,575
WATER	288	13,358,693	8,872,128	-33.59%	6,590,267
SEWER:					
STORMWATER	272	674,110	641,577	-4.83%	
MAIN STREET LEVEES	274	80,321	100,585	25.23%	
SLUDGE DISPOSAL	276	478,143	580,503	21.41%	
PLANT OPERATIONS	278	9,288,137	10,041,221	8.11%	
LINE MAINTENANCE	280	1,936,651	847,875	-56.22%	
TOTAL SEWER		12,457,362	12,211,761	-1.97%	7,243,800
GRAND TOTAL		\$31,888,173	\$27,390,446	-14.10%	\$17,541,642

INTERNAL SERVICE

**OPERATING EXPENDITURES**

<u>PROGRAM/SERVICE</u>	<u>2015-2016 BUDGET</u>	<u>2016-2017 BUDGET</u>	<u>% CHANGE</u>	<u>PROGRAM INCOME</u>
INFORMATION TECHNOLOGY	\$566,750	\$592,414	4.53%	\$703,000
FLEET	1,429,008	1,462,818	2.37%	1,462,818
EMPLOYEE BENEFITS	3,593,007	3,569,122	-0.66%	3,629,089
RISK MANAGEMENT	538,450	554,923	3.06%	554,923
EQUIPMENT REPLACEMENT	-	-	0.00%	378,857
<b>TOTAL OPERATING EXPENDITURES</b>	<b>\$6,127,215</b>	<b>\$6,179,277</b>	<b>0.85%</b>	<b>\$6,728,687</b>

**CAPITAL OUTLAY**

<u>PROGRAM/SERVICE</u>	<u>2015-2016 BUDGET</u>	<u>2016-2017 BUDGET</u>	<u>% CHANGE</u>
INFORMATION TECHNOLOGY	\$120,000	\$137,200	14.33%
FLEET	-	-	0.00%
EMPLOYEE BENEFITS	-	-	0.00%
RISK MANAGEMENT	-	-	0.00%
EQUIPMENT REPLACEMENT	449,016	532,500	18.59%
<b>TOTAL CAPITAL OUTLAY</b>	<b>\$569,016</b>	<b>\$669,700</b>	<b>17.69%</b>

**TOTAL EXPENDITURES**

<u>PROGRAM/SERVICE</u>	<u>PAGE NUMBER</u>	<u>2015-2016 BUDGET</u>	<u>2016-2017 BUDGET</u>	<u>% CHANGE</u>	<u>PROGRAM INCOME</u>
INFORMATION TECHNOLOGY	335	\$686,750	\$729,614	6.24%	\$703,000
FLEET	341	1,429,008	1,462,818	2.37%	1,462,818
EMPLOYEE BENEFITS	345	3,593,007	3,569,122	-0.66%	3,629,089
RISK MANAGEMENT	349	538,450	554,923	3.06%	554,923
EQUIPMENT REPLACEMENT	353	449,016	532,500	18.59%	378,857
<b>GRAND TOTAL</b>		<b>\$6,696,231</b>	<b>\$6,848,977</b>	<b>2.28%</b>	<b>\$6,728,687</b>

---

THIS PAGE INTENTIONALLY LEFT BLANK

---

---

**SUMMARY OF  
REVENUE  
AND  
EXPENSES  
BY FUND  
AND  
FUND TYPES**



COMBINED STATEMENT OF REVENUES COLLECTED, EXPENDITURES PAID  
AND CHANGES IN GOVERNMENTAL FUND BALANCES  
GENERAL, SPECIAL REVENUE, DEBT SERVICE AND CAPITAL PROJECTS FUND TYPES  
ENTERPRISE AND INTERNAL SERVICE FUND TYPES

	2013-14 <u>ACTUAL</u>	2014-15 <u>ACTUAL</u>	2015-16 <u>BUDGET</u>	2016-17 <u>PROPOSED</u>
REVENUES COLLECTED:				
TAXES	\$39,347,675	\$40,616,991	\$39,361,036	\$42,025,876
LICENSES AND PERMITS	1,604,594	1,578,127	1,632,776	1,640,944
INTERGOVERN REVENUE	3,456,404	5,028,960	2,501,168	3,241,007
SERVICE CHARGES	26,971,423	27,187,668	26,958,925	27,711,423
FINES AND FORFEITS	749,246	712,649	785,555	695,650
MISCELLANEOUS	1,743,259	2,042,432	1,579,562	1,656,949
OTHER FINANCING	<u>32,283,727</u>	<u>13,091,931</u>	<u>5,151,145</u>	<u>127,226</u>
TOTAL REVENUE	\$106,156,328	\$90,258,758	\$77,970,167	\$77,099,075
EXPENSE OBJECT:				
PERSONNEL SERVICES	\$23,835,710	\$24,425,573	\$25,660,426	\$26,380,798
MATERIALS & SUPPLIES	5,388,146	5,634,378	6,071,266	6,042,314
CONTRACTUAL SERVICES	13,040,752	13,734,377	13,912,109	14,767,210
GENERAL OPERATIONS	1,165,068	1,138,637	1,278,400	1,310,862
CAPITAL OUTLAY	12,248,255	13,594,059	25,682,635	32,536,970
SPECIAL PROJECTS	3,556,831	7,582,771	1,948,869	1,808,985
DEBT SERVICE	<u>8,236,387</u>	<u>10,403,564</u>	<u>11,494,570</u>	<u>14,341,956</u>
TOTAL EXPENSES	<u>\$67,471,150</u>	<u>\$76,513,360</u>	<u>\$86,048,275</u>	<u>\$97,189,095</u>
FUND TRANSFERS IN *	2,707,983	5,447,356	11,921,343	8,178,271
FUND TRANSFERS OUT *	2,985,345	5,572,201	14,667,343	10,171,271
PROJECTED REVENUE				
OVER(UNDER) BUDGET			47,485,614	-
PROJECTED EXPENDITURES				
UNDER(OVER) BUDGET			(27,147,829)	-
RESERVED FUND BALANCE				
DECREASE(INCREASE)			(172,262)	(220,379)
EMERGENCY RESERVE FUND BALANCE				
DECREASE(INCREASE)			(26,725)	(438,495)
BEGINNING UNRESERVED FUND				
BALANCE			36,890,419	46,205,109
ENDING UNRESERVED FUND				
BALANCE			<u>46,205,109</u>	<u>23,463,215</u>
EMERGENCY RESERVE FUND			<u>7,865,261</u>	<u>8,303,756</u>

\* Eliminates interfund transfers between annually budgeted governmental funds.

## TOTAL BUDGET 2016-2017 RESOURCES

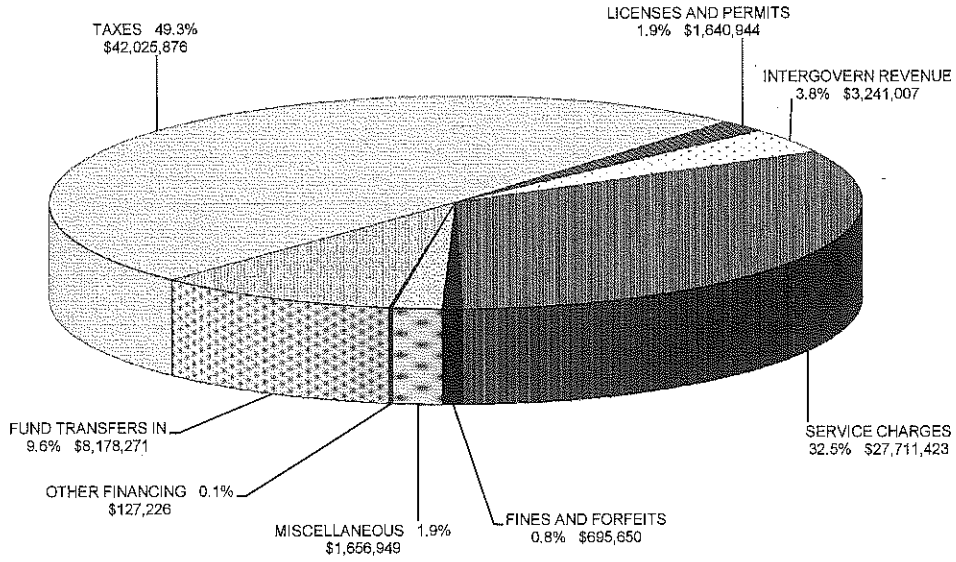

## TOTAL BUDGET 2016-2017 EXPENDITURES

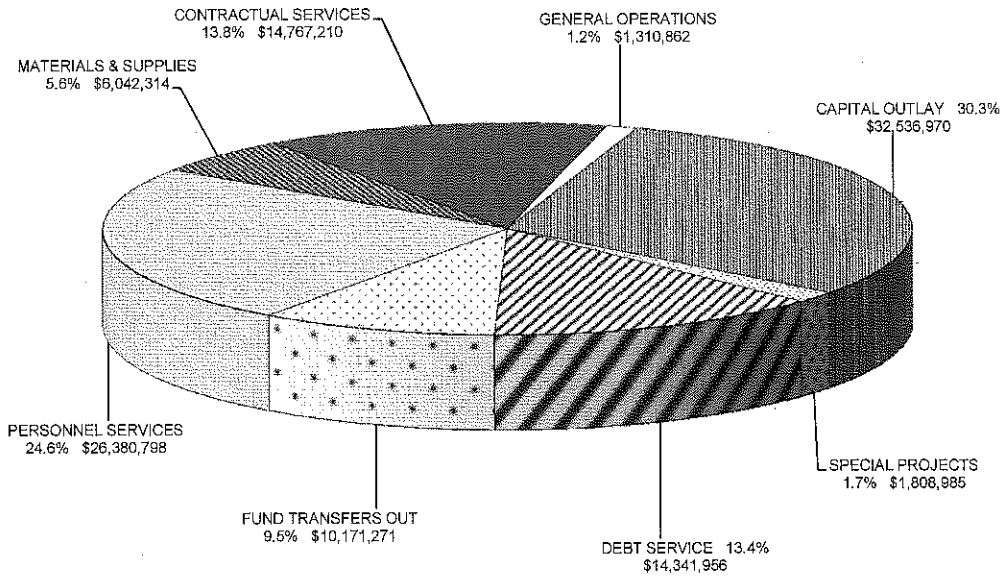

COMBINED STATEMENT OF REVENUES COLLECTED, EXPENDITURES PAID  
AND CHANGES IN GOVERNMENTAL FUND BALANCES  
GENERAL, SPECIAL REVENUE, DEBT SERVICE AND CAPITAL PROJECTS FUND TYPES

	2013-14 <u>ACTUAL</u>	2014-15 <u>ACTUAL</u>	2015-16 <u>BUDGET</u>	2016-17 <u>PROPOSED</u>
<b>REVENUES COLLECTED:</b>				
TAXES	\$39,347,675	\$40,616,991	\$39,361,036	\$42,025,876
LICENSES AND PERMITS	1,604,594	1,578,127	1,632,776	1,640,944
INTERGOVERN REVENUE	3,445,446	5,028,960	2,501,168	3,241,007
SERVICE CHARGES	2,965,181	3,511,441	2,893,669	3,252,705
FINES AND FORFEITS	749,246	712,649	785,555	695,650
MISCELLANEOUS	979,476	1,296,264	914,120	938,782
OTHER FINANCING	242,884	658,031	4,176,757	95,773
<b>TOTAL REVENUE</b>	<b>\$49,334,502</b>	<b>\$53,402,463</b>	<b>\$52,265,081</b>	<b>\$51,890,737</b>
<b>EXPENSE OBJECT:</b>				
PERSONNEL SERVICES	\$18,913,486	\$19,426,069	\$20,451,066	\$21,131,251
MATERIALS & SUPPLIES	2,692,988	2,833,162	2,787,424	2,597,237
CONTRACTUAL SERVICES	3,649,983	4,158,593	4,021,048	4,219,610
GENERAL OPERATIONS	365,221	344,328	414,053	462,226
CAPITAL OUTLAY	4,505,234	7,301,481	16,338,119	28,345,893
SPECIAL PROJECTS	3,154,892	5,142,197	1,541,435	1,630,988
DEBT SERVICE	3,882,181	4,833,566	3,138,426	5,678,228
<b>TOTAL EXPENSES</b>	<b>\$37,163,985</b>	<b>\$44,039,394</b>	<b>\$ 48,691,571</b>	<b>\$ 64,065,433</b>
FUND TRANSFERS IN *	135,456	68,284	43,765	71,625
FUND TRANSFERS OUT *	2,889,888	5,549,541	14,623,578	10,094,851
PROJECTED REVENUE OVER(UNDER) BUDGET			37,828,262	-
PROJECTED EXPENDITURES UNDER(OVER) BUDGET			(20,356,230)	-
RESERVED FUND BALANCE DECREASE(INCREASE)			-	-
EMERGENCY RESERVE FUND BALANCE DECREASE(INCREASE)			420	(169,624)
BEGINNING UNRESERVED FUND BALANCE			32,024,898	38,491,037
ENDING UNRESERVED FUND BALANCE			<u>38,491,037</u>	<u>16,123,491</u>
EMERGENCY RESERVE FUND			<u>5,060,882</u>	<u>5,230,506</u>

\* Eliminates interfund transfers between annually budgeted governmental funds.

## GOVERNMENTAL FUNDS 2016-2017 RESOURCES

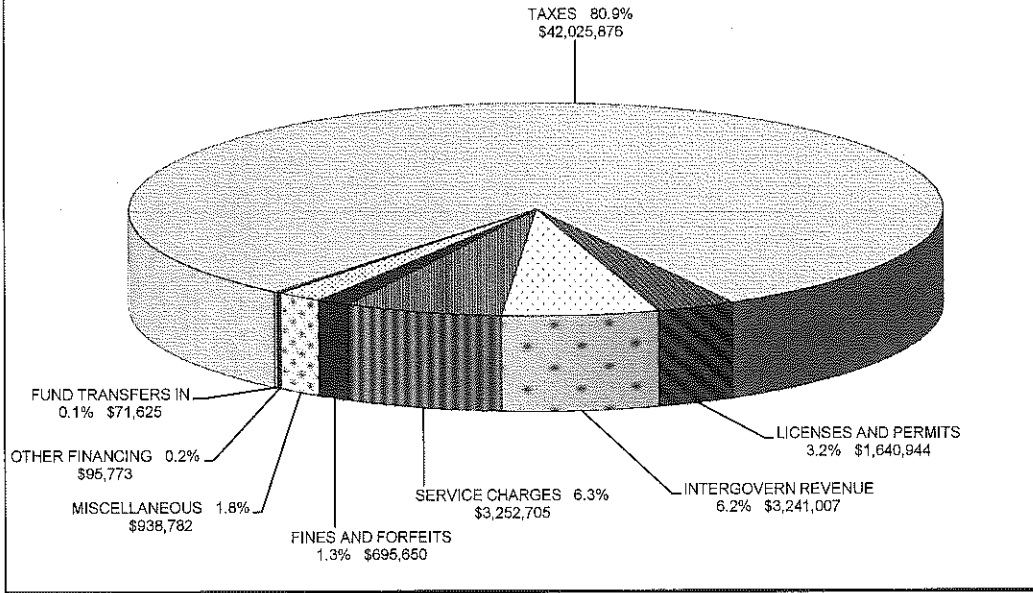

## GOVERNMENTAL FUNDS 2016-2017 EXPENDITURES

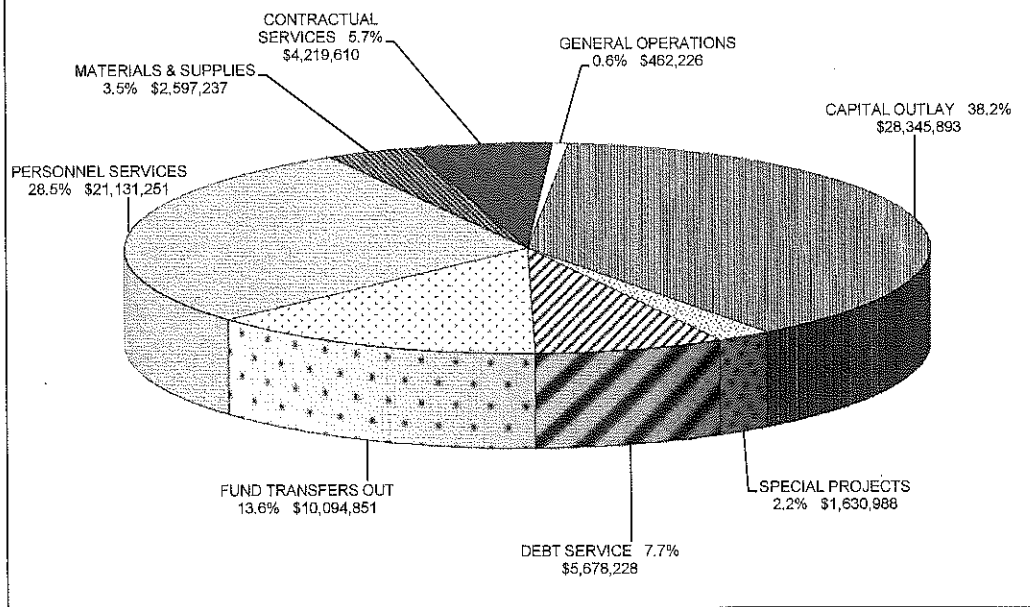

City of Cape Girardeau, Missouri  
 COMBINED STATEMENT OF REVENUES COLLECTED, EXPENDITURES PAID  
 AND CHANGES IN PROPRIETARY FUND TYPES  
 ENTERPRISE AND INTERNAL SERVICE FUND TYPES

	2013-14 <u>ACTUAL</u>	2014-15 <u>ACTUAL</u>	2015-16 <u>BUDGET</u>	2016-17 <u>PROPOSED</u>
REVENUES COLLECTED:				
TAXES	\$ -	\$ -	\$ -	\$ -
LICENSES AND PERMITS	-	-	-	-
INTERGOVERN REVENUE	10,958	-	-	-
SERVICE CHARGES	24,006,242	23,676,227	24,065,256	24,458,718
FINES AND FORFEITS	-	-	-	-
MISCELLANEOUS	763,783	746,168	665,442	718,167
OTHER FINANCING	<u>32,040,843</u>	<u>12,433,900</u>	<u>974,388</u>	<u>31,453</u>
TOTAL REVENUE	\$56,821,826	\$36,856,295	\$25,705,086	\$25,208,338
EXPENSE OBJECT:				
PERSONNEL SERVICES	\$4,922,224	\$4,999,504	\$5,209,360	\$5,249,547
MATERIALS & SUPPLIES	2,695,158	2,801,216	3,283,842	3,445,077
CONTRACTUAL SERVICES	9,390,769	9,575,784	9,891,061	10,547,600
GENERAL OPERATIONS	799,847	794,310	864,347	848,636
CAPITAL OUTLAY	7,743,021	6,292,578	9,344,516	4,191,077
SPECIAL PROJECTS	401,939	2,440,574	407,434	177,997
DEBT SERVICE	<u>4,354,206</u>	<u>5,569,998</u>	<u>8,356,144</u>	<u>8,663,728</u>
TOTAL EXPENSES	<u>\$30,307,165</u>	<u>\$32,473,965</u>	<u>\$37,356,704</u>	<u>\$33,123,662</u>
FUND TRANSFERS IN *	2,572,527	5,379,072	11,877,578	8,106,646
FUND TRANSFERS OUT *	95,456	22,660	43,765	76,420
PROJECTED REVENUE				
OVER(UNDER) BUDGET			9,657,362	-
PROJECTED EXPENDITURES				
UNDER(OVER) BUDGET			(6,791,599)	-
RESERVED FUND BALANCE				
DECREASE (INCREASE)			(172,262)	(220,379)
EMERGENCY RESERVE FUND BALANCE				
DECREASE (INCREASE)			(27,145)	(268,871)
BEGINNING UNRESERVED FUND				
BALANCE			4,865,521	7,714,072
ENDING UNRESERVED FUND				
BALANCE			<u>7,714,072</u>	<u>7,339,724</u>
EMERGENCY RESERVE FUND			<u>2,804,379</u>	<u>3,073,250</u>

\* Eliminates interfund transfers between enterprise funds.

## PROPRIETARY FUNDS 2016-2017 RESOURCES

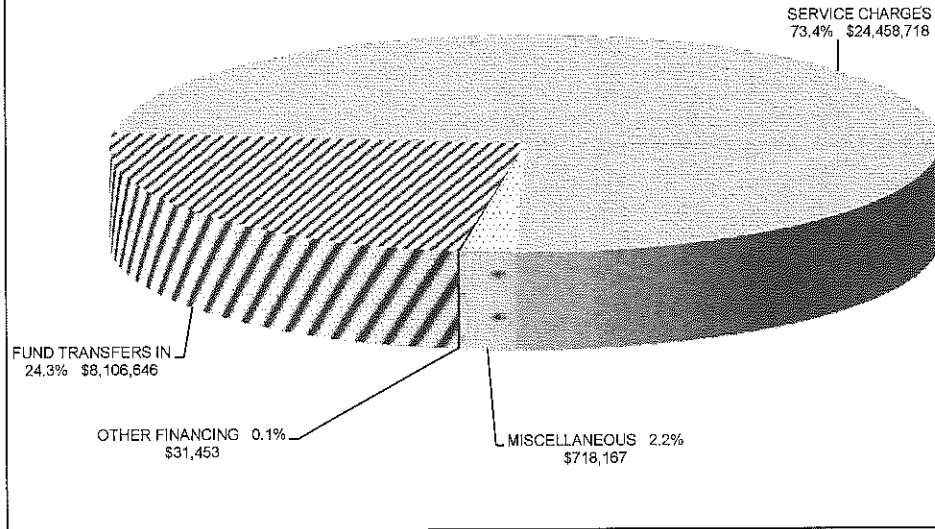

## PROPRIETARY FUNDS 2016-2017 EXPENDITURES

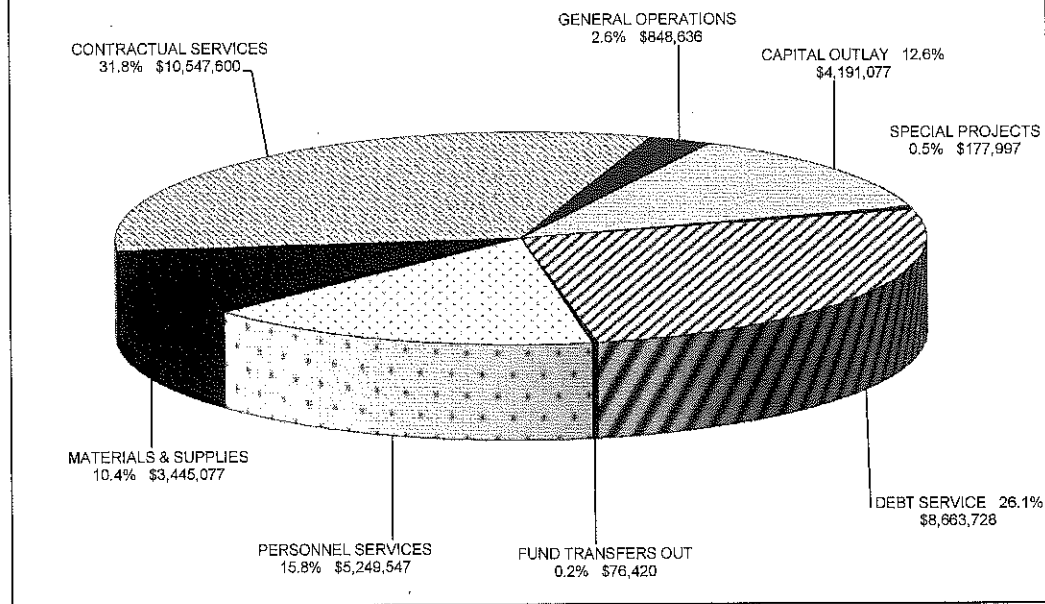

ALL FUNDS REVENUE

BUDGET BY FUND

	2013-14 <u>ACTUAL</u>	2014-15 <u>ACTUAL</u>	2015-16 <u>BUDGET</u>	2016-17 <u>BUDGET</u>
GENERAL FUND	\$26,529,189	\$27,748,722	\$27,525,577	\$27,989,915
AIRPORT FUND	1,475,472	2,089,000	1,426,878	2,326,338
PARKS & RECREATION	2,405,115	2,554,096	2,578,061	2,675,445
HEALTH	356,639	359,697	367,497	374,218
CONVENTION/VISITORS	2,020,753	2,143,363	2,142,710	2,242,596
DOWNTOWN BUS DISTRICT	32,561	39,174	27,430	27,250
PUBLIC SAFETY TRUST FUND	2,322,718	1,768,721	-	-
PUBLIC SAFETY TRUST FUND II	-	755,465	2,835,333	2,921,668
CASINO REVENUE FUND	3,576,036	3,585,294	3,225,000	3,225,000
RIVERFRONT REGION ECONOMIC DEVL	113,116	361,353	370,000	380,000
HOUSING DEVELOPMENT GRANTS	149,834	180,753	200,000	200,000
MOTOR FUEL TAX	1,568,014	1,643,197	1,458,355	1,490,000
TRANSPORTATION SALES TAX	13,455	50	-	-
TRANSPORTATION SALES TAX II	21,201	-	-	-
TRANSPORTATION SALES TAX III	64,332	43,953	-	-
TRANSPORTATION SALES TAX IV	5,065,414	5,297,034	3,125,000	25,000
TRANSPORTATION SALES TAX V	-	-	-	5,195,420
CAP IMPR SALES TAX - WATER	2,502,242	2,615,522	2,666,250	2,316,000
CAP IMPR SALES TAX - SEWER	2,478,052	2,580,566	2,631,250	3,091,800
FIRE SALES TAX FUND	2,367,707	2,459,550	2,502,000	2,588,335
PARK/STORMWATER SALES TAX -OPERATIC	1,235,474	1,281,482	1,305,625	1,336,950
PARK/STORMWATER SALES TAX -CAPITAL	3,751,086	3,894,221	3,934,375	4,045,850
GENERAL LONG TERM BOND	324	-	-	-
GENERAL CAPITAL IMPROV	614,345	53,426	-	-
STREET IMPROVEMENT	19,571	17,777	4,105,643	-
PARK IMPROVEMENTS	234	812,837	-	-
SURFACE TRANS PROG-URBAN PROJ FE	(24,477)	53,889	200,000	-
CDBG GRANTS	77,439	2,981,308	-	-
SEWER OPERATIONS	41,271,066	21,589,666	12,708,523	12,262,128
WATER OPERATIONS	6,467,409	7,774,559	13,229,055	8,928,067
SOLID WASTE	3,179,856	4,283,396	3,330,683	3,707,575
GOLF COURSE	642,871	608,335	627,174	614,184
SOFTBALL COMPLEX	988,127	1,069,671	1,000,645	1,057,890
INFORMATION TECHNOLOGY	625,178	647,191	686,750	703,000
FLEET MANAGEMENT	1,462,867	1,477,426	1,445,176	1,479,271
EMPLOYEE BENEFITS	3,773,353	3,842,558	3,620,604	3,629,089
RISK MANAGEMENT	639,544	538,040	538,450	554,923
EQUIPMENT REPLACEMENT	345,892	407,947	395,604	378,857
TOTAL REVENUE	<u>\$118,132,008</u>	<u>\$107,559,238</u>	<u>\$100,209,648</u>	<u>\$95,766,769</u>
LESS TRANSFERS	<u>2,707,984</u>	<u>5,447,356</u>	<u>11,921,343</u>	<u>8,178,271</u>
NET REVENUE	<u>\$115,424,024</u>	<u>\$102,111,883</u>	<u>\$88,288,305</u>	<u>\$87,588,498</u>

ALL FUNDS EXPENSE

BUDGET BY FUND

	2013-14 <u>ACTUAL</u>	2014-15 <u>ACTUAL</u>	2015-16 <u>BUDGET</u>	2016-17 <u>BUDGET</u>
GENERAL FUND	\$26,343,851	\$27,902,777	\$27,649,956	\$28,118,703
AIRPORT FUND	1,498,374	1,465,886	1,426,878	2,326,338
PARKS & RECREATION	2,355,203	2,519,150	2,578,061	2,675,445
HEALTH	365,218	482,085	467,497	474,218
CONVENTION/VISITORS	2,024,302	1,936,560	2,314,438	2,020,611
DOWNTOWN BUS DISTRICT	10,122	25,081	27,430	27,250
PUBLIC SAFETY TRUST FUND	2,680,790	2,315,073	-	25,000
PUBLIC SAFETY TRUST FUND II	-	675,481	1,337,256	2,817,804
CASINO REVENUE FUND	2,475,306	1,970,702	5,578,638	804,107
RIVERFRONT REG. ECONOMIC DEVL	105	100,800	455,200	860,000
HOUSING DEVELOPMENT GRANTS	91,874	231,055	200,000	200,000
MOTOR FUEL TAX	1,335,118	1,393,665	1,420,000	1,920,000
TRANSPORTATION SALES TAX	-	25,637.41	-	-
TRANSPORTATION SALES TAX II	25,000	1,562	-	-
TRANSPORTATION SALES TAX III	53,209	1,930	-	2,000,000
TRANSPORTATION SALES TAX IV	941,846	3,796,361	5,412,500	3,825,000
TRANSPORTATION SALES TAX V	-	-	-	4,550,600
CAP IMPR SALES TAX-WATER	214,591	3,343,644	6,842,345	2,510,684
CAP IMPR SALES TAX-SEWER	1,614,336	1,767,751	4,380,000	4,713,475
FIRE SALES TAX FUND	2,302,317	2,509,834	2,502,000	2,588,335
PARK/STORMWATER SALES TX-OPERATIONS	1,278,730	1,384,563	1,225,994	1,444,249
PARK/STORMWATER SALES TX -CAPITAL	2,850,401	3,237,160	5,515,094	5,032,888
GENERAL LONG TERM BOND	-	26,335	-	-
GENERAL CAPITAL IMPROV	726,967	8,602	-	15,715,000
STREET IMPROVEMENT	-	473,971	4,100,000	-
PARK IMPROVEMENTS	3,194	816,997	-	-
SURFACE TRANS PROG-URBAN PROJ	(15,343)	76,708	200,000	-
CDBG GRANTS	144,252	2,949,267	-	-
SEWER OPERATIONS	11,177,997	11,126,261	12,457,362	12,211,761
WATER OPERATIONS	8,261,729	7,376,755	13,358,693	8,872,128
SOLID WASTE	3,340,318	4,447,770	3,216,599	3,518,722
GOLF COURSE	651,075	585,531	627,174	614,184
SOFTBALL COMPLEX	977,043	965,842	1,000,645	1,057,890
INFORMATION TECHNOLOGY	617,932	675,286	686,750	729,614
FLEET MANAGEMENT	1,403,718	1,450,803	1,445,176	1,479,271
EMPLOYEE BENEFITS	3,020,344	4,891,117	3,620,604	3,629,089
RISK MANAGEMENT	669,022	745,119	538,450	554,923
EQUIPMENT REPLACEMENT	285,252	235,564	449,016	532,500
TOTAL EXPENSES	\$79,724,191	\$93,938,685	\$111,033,756	\$117,849,789
LESS TRANSFERS	<u>2,985,345</u>	<u>5,572,201</u>	<u>14,667,343</u>	<u>10,171,271</u>
NET EXPENSE	<u>\$76,738,847</u>	<u>\$88,366,484</u>	<u>\$96,366,413</u>	<u>\$107,678,518</u>



---

THIS PAGE INTENTIONALLY LEFT BLANK

---

---

**GENERAL FUND  
BUDGET HIGHLIGHTS**

**SIGNIFICANT OPERATING CHANGES**

**City Manager** – This budget includes the deputy city manager position that was added during current year. Total personnel costs associated with this addition were \$122,396.

**Inspection** – A portion of the additional cost of adding the deputy city manager position during the current year was covered by reducing a full-time plan review specialist position to a part-time position. This budget reestablishes this position as a full-time position. Total additional cost associated with this change is \$25,176 and will be covered by addition revenues resulting from changes to the City's Inspection Service's fee schedule.

**Police** – This budget includes the addition of three grant funded police officer positions that were added during current year. Total personnel costs associated with these positions are \$157,329. These costs will be 75% funded for three years.

**Fire** – This budget includes a \$55,000 addition to the annual allowance for overtime at a total cost of \$67,745. Previous budgets have not allowed enough allowance to meet minimum staffing requirements.

**Contingency** – This budget includes one-time allocations of \$120,000 to cover potential extra police and fire personnel costs during the year. It also includes \$130,000 to cover other potential costs during the year. These allowances are similar those included in the current year's budget. This budget also adds a one-time allocation of \$31,782 for temporary administrative help during the year.

**SIGNIFICANT ONE-TIME EXPENDITURES**

This budget includes \$8,044 for one-time administrative department expenditures for costs related to a professional review of the city's code of ordinances and a new credit card machine. Development Service divisions' budgets include \$5,500 for training, laptop computer, refrigerator replacement and conference room chairs. The street division's budget includes one-time expenditures totaling \$229,660 for replenishing salt supplies, two used pick-up trucks, and other various small equipment costs. This budget also includes a one-time transfer to the airport fund of \$224,506. This transfer will fund various capital projects and grant matches associated with one-time operating and capital grants.

All of these expenditures will be covered by a \$475,000 one-time transfer from the motor fuel tax fund.

This budget also includes \$3,000 for landscape projects at the cemeteries and \$3,650 for training and small equipment for the parks maintenance division. These costs will be funded by a transfer from the parks / stormwater sales tax – operations fund.

---

## REVENUE/RATE INCREASES

This budget proposes changes to the City's Inspection Service's fee schedule. These changes are projected to provide an additional \$50,000 in revenue. The proposed fee schedule is included in pages 384 – 387. As new activities arise during the year, user fees may be charged to offset operating costs.

## REVENUE/EXPENDITURE PROJECTIONS

The following assumptions were used for the proposed budget for the fiscal year ending June 30, 2017 and projections for the following five years.

Inflation is projected to be 2% during the entire 6-year period.

Sales tax for the fiscal year ending June 30, 2017 is projected to be 2.0% above the current projected sales tax for fiscal year ending June 30, 2015. The current year's revenue is projected to be 3.22% more than the actual revenue received in fiscal year ending June 30, 2015. Sales tax is projected to increase 3.00% per year thereafter.

Cable Franchise Tax for the fiscal year ending June 30, 2017 is projected to be 3.5% above the current projected Cable franchise tax for fiscal year ending June 30, 2016. The current year's revenue is projected to be 1.2% less than the actual revenue received in fiscal year ending June 30, 2015. Cable franchise tax is projected to increase 3.00% per year thereafter.

Real Estate and Property Tax assessed valuations are projected to grow at 1.5% and 3.0% respectively for the fiscal year ending June 30, 2017 and 2.0% annually for the following five years. No tax levy increases are assumed in any of the years.

Franchise Tax from AmerenUE is projected for the fiscal year ending June 30, 2017 using 103% of the average electric and natural gas usage from the last 3 calendar years ending in 2015 and rates currently in effect. Revenues are projected to increase 2% per year thereafter.

Court Revenue is projected at amounts received during the 2015 calendar year and projected to grow at the rate of inflation for the remaining 5 years.

All other fees and licenses that are allowed to be adjusted without voter approval are projected to grow at the rate of inflation for the remaining 5 years. The remaining fees and licenses are maintained at current levels.

Operating expenditures, excluding personnel costs and internal equipment rent, are projected grow at the rate of inflation in years following fiscal year ending June 30, 2017. Personnel expenditures are projected to include wage increases equal to the inflation rate in the fiscal years after June 30, 2017 and an annual turnover rate of 5%. Costs for health and dental insurance are projected to grow 6% and 3% annually, respectively, during these years.

Internal equipment rent expense is projected to remain at June 30, 2017 levels during the following five years.

---

**REVENUE/EXPENDITURE PROJECTIONS (cont.)**

No capital expenditures are projected for years following fiscal year ending June 30, 2017.

Debt Service for fiscal year ending June 30, 2018 includes \$1,005,200 for the payoff of the 2015A Special Obligation Bonds. A \$985,000 transfer in from the Capital Improvement Sale Tax Fund – Sewer System Improvements is also reflected during that year.

Motor Fuel Fund transfers received by the General Fund for operations total \$1,445,000 for fiscal year ending June 30, 2017 and are projected to be maintained at \$1,160,000 over the following five years.

Fire Sales Tax Fund transfers received by the General Fund for operations total \$2,588,335 for fiscal year ending June 30, 2017 and are projected to grow 3.00% annually over the following five years.

Public Safety Trust Fund transfers received by the General Fund for operations total \$1,294,115 for fiscal year ending June 30, 2017 and are projected to grow 3.00% annually over the remaining five years.

Transfers to the Public Safety Trust Fund total \$2,588,335 for fiscal year ending June 30, 2017 and are projected to be equal to the Fire Sales Tax Fund transfers received by the General Fund for operations for the follow five years.

Transfers to Airport, Parks and Recreation, and Softball Complex funds are made at levels to enable them to have balanced budgets.

Unreserved fund balance is projected to decrease from \$2,270,560 at the end of the fiscal year ending June 30, 2017 to \$2,015,415 by the end of fiscal year ending June 30, 2022.

The fund balance reserved for emergency is kept at 15% of annually budgeted operating expenses during the six year period as required by City Charter. The general fund is projected to cover shortfalls in the solid waste fund's emergency reserve fund for fiscal years ending June 30, 2017 through June 30, 2019.

---

THIS PAGE INTENTIONALLY LEFT BLANK

---

## GENERAL FUND 2016-2017 RESOURCES

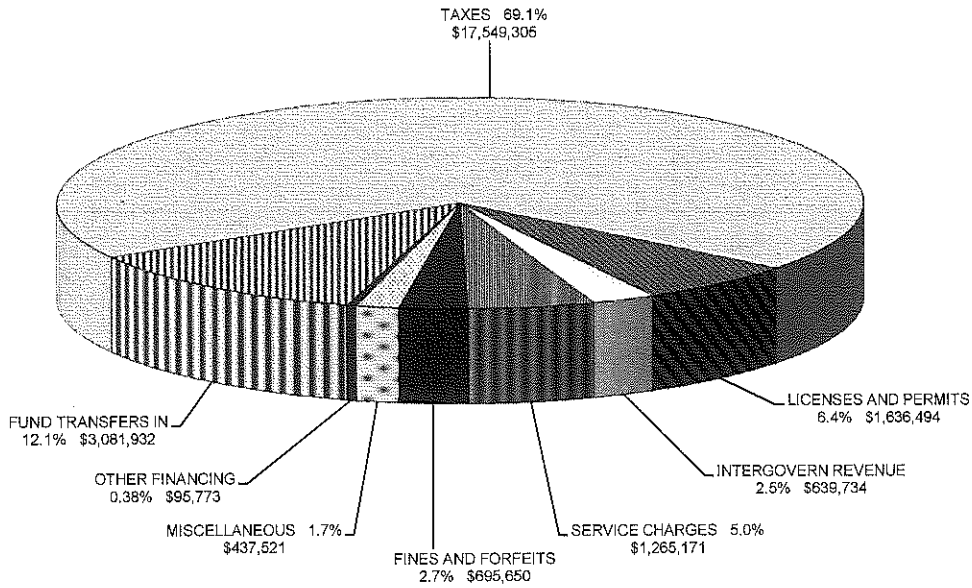

## GENERAL FUND 2016-2017 EXPENDITURES

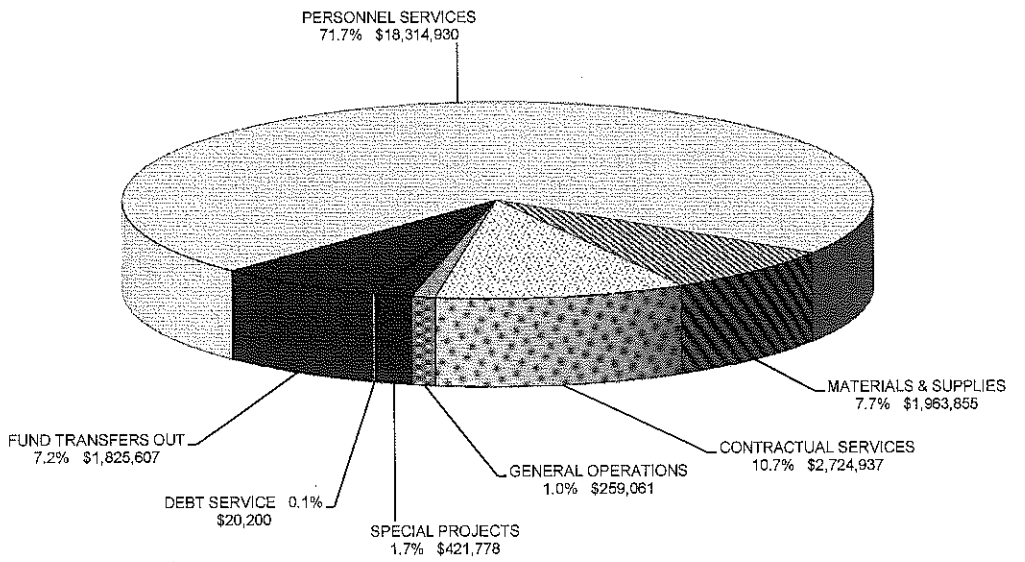

GENERAL FUND  
BUDGET BY MAJOR OBJECT

	2013-14 <u>ACTUAL</u>	2014-15 <u>ACTUAL</u>	2015-16 <u>BUDGET</u>	2016-17 <u>BUDGET</u>
REVENUE SOURCE:				
TAXES	\$16,806,459	\$17,123,367	\$17,430,337	\$17,549,305
LICENSES AND PERMITS	1,600,103	1,575,615	1,628,298	1,636,494
INTERGOVERN REVENUE	860,891	718,152	504,958	639,734
SERVICE CHARGES	1,265,846	1,211,269	1,215,909	1,265,171
FINES AND FORFEITS	749,246	712,649	785,555	695,650
MISCELLANEOUS	408,827	564,271	425,944	437,521
OTHER FINANCING	<u>106,409</u>	<u>638,811</u>	<u>66,966</u>	<u>95,773</u>
TOTAL REVENUE	\$21,797,781	\$22,544,134	\$22,057,967	\$22,319,648
EXPENSE OBJECT:				
PERSONNEL SERVICES	\$16,347,553	\$16,785,165	\$17,718,055	\$18,314,930
MATERIALS & SUPPLIES	1,993,190	2,104,913	2,071,955	1,963,855
CONTRACTUAL SERVICES	2,418,047	2,624,880	2,673,976	2,724,937
GENERAL OPERATIONS	229,366	226,262	248,724	259,061
CAPITAL OUTLAY	144,346	114,910	-	-
SPECIAL PROJECTS	687,611	499,978	437,370	421,778
DEBT SERVICE	<u>157,348</u>	<u>428,196</u>	<u>127,987</u>	<u>20,200</u>
TOTAL EXPENSES	<u>\$21,977,461</u>	<u>\$22,784,304</u>	<u>\$23,278,067</u>	<u>\$23,704,761</u>
FUND TRANSFERS IN	4,731,408	5,204,588	5,467,610	5,670,267
FUND TRANSFERS OUT	4,366,390	5,118,473	4,371,889	4,413,942
PROJECTED REVENUE OVER(UNDER) BUDGET			944,221	
PROJECTED EXPENDITURES UNDER(OVER) BUDGET			(1,135,401)	
RESERVED FUND BALANCE DECREASE(INCREASE)				
EMERGENCY RESERVE FUND BALANCE DECREASE(INCREASE)				(35,561)
BEGINNING UNRESERVED FUND BALANCE			2,749,818	2,434,259
ENDING UNRESERVED FUND BALANCE			<u>2,434,259</u>	<u>2,269,910</u>
EMERGENCY RESERVE FUND			<u>4,481,729</u>	<u>4,517,290</u>

GENERAL FUND  
BUDGET PROJECTIONS

	2017-18 <u>PROJECTED</u>	2018-19 <u>PROJECTED</u>	2019-20 <u>PROJECTED</u>	2020-21 <u>PROJECTED</u>	2021-22 <u>PROJECTED</u>
REVENUE SOURCE:					
TAXES	\$17,999,122	\$18,461,410	\$18,936,525	\$19,424,827	\$19,926,693
LICENSES AND PERMITS	1,679,716	1,724,200	1,769,987	1,817,111	1,865,615
INTERGOVERN REVENUE	654,748	670,115	685,844	701,944	718,423
SERVICE CHARGES	1,289,787	1,319,267	1,349,427	1,380,281	1,411,848
FINES AND FORFEITS	548,250	559,062	570,090	581,339	592,813
MISCELLANEOUS	440,876	445,250	452,069	460,236	469,795
OTHER FINANCING	48,491	25,000	25,000	25,000	25,000
<b>TOTAL REVENUE</b>	<b>\$22,660,990</b>	<b>\$23,204,304</b>	<b>\$23,788,942</b>	<b>\$24,390,738</b>	<b>\$25,010,187</b>
EXPENSE OBJECT:					
PERSONNEL SERVICES	\$18,572,660	\$19,006,835	\$19,455,303	\$19,918,717	\$20,397,761
MATERIALS & SUPPLIES	1,969,641	2,005,234	2,041,539	2,078,570	2,116,341
CONTRACTUAL SERVICES	2,768,117	2,817,261	2,867,388	2,918,517	2,970,669
GENERAL OPERATIONS	264,242	269,527	274,918	280,416	286,024
CAPITAL OUTLAY	-	-	-	-	-
SPECIAL PROJECTS	430,214	438,818	447,594	456,546	465,677
DEBT SERVICE	1,005,200	-	-	-	-
<b>TOTAL EXPENSES</b>	<b>\$25,010,074</b>	<b>\$24,537,675</b>	<b>\$25,086,742</b>	<b>\$25,652,766</b>	<b>\$26,236,472</b>
FUND TRANSFERS IN	6,474,823	5,652,211	5,820,534	5,994,730	6,175,358
FUND TRANSFERS OUT	4,313,061	4,393,852	4,502,542	4,614,178	4,728,867
PROJECTED REVENUE OVER(UNDER) BUDGET					
PROJECTED EXPENDITURES UNDER(OVER) BUDGET					
RESERVED FUND BALANCE DECREASE(INCREASE)					
EMERGENCY RESERVE FUND BALANCE DECREASE(INCREASE)	(213,525)	138,780	(65,612)	(104,086)	(107,246)
BEGINNING UNRESERVED FUND BALANCE	2,269,910	1,869,063	1,932,831	1,887,411	1,901,849
ENDING UNRESERVED FUND BALANCE	<u>1,869,063</u>	<u>1,932,831</u>	<u>1,887,411</u>	<u>1,901,849</u>	<u>2,014,809</u>
EMERGENCY RESERVE FUND	<u>4,730,815</u>	<u>4,592,035</u>	<u>4,657,647</u>	<u>4,761,733</u>	<u>4,868,979</u>



GENERAL FUND REVENUE

	2013-14 <u>ACTUAL</u>	2014-15 <u>ACTUAL</u>	2015-16 <u>BUDGET</u>	2016-17 <u>PROPOSED</u>
Real Estate Tax	\$ 1,367,259	\$ 1,387,002	\$ 1,420,197	\$ 1,426,900
Personal Property Tax	322,629	333,246	339,365	365,550
Railroad & Utility Tax	58,081	60,176	61,075	63,935
Intangible Tax	11,022	4,854	4,850	7,450
Delinquent Real Estate Tax	18,731	21,003	20,175	23,000
Delinquent Personal Prop Tax	12,351	12,236	12,300	13,000
Public Utility Franchise Tax	2,783,887	2,740,067	2,800,000	2,667,400
Natural Gas Franchise Tax	829,328	811,393	710,000	669,500
Local Telephone Franchise Tax	312,970	318,921	305,070	315,865
Cable T.V. Franchise Tax	420,253	437,188	448,000	447,000
P.I.L.O.T. - Franchise Tax Sewe	682,322	662,261	359,540	352,290
P.I.L.O.T. - Franchise Tax Wate	-	-	322,460	325,415
General Sales Tax	9,802,998	10,158,934	10,445,000	10,695,600
Cigarette Tax	174,366	166,088	171,300	165,000
Penalty on Delinquent R.E. Tax	6,221	5,720	6,815	6,900
Penalty on Delinquent P.P. Tax	4,043	4,279	4,190	4,500
	<u>16,806,459</u>	<u>17,123,367</u>	<u>17,430,337</u>	<u>17,549,305</u>
Gen Business License-Flat fee	26,125	22,886	24,973	25,149
Gen Business Lic-Gross receipts	1,320,439	1,287,741	1,325,000	1,323,960
Liquor Licenses	69,959	73,565	70,000	71,500
Trade Licenses	23,205	21,780	23,800	23,325
Residential Rental Licenses	35,611	50,470	69,025	14,960
Security Guard Licenses	4,675	6,760	5,000	6,000
Business License-penalty	4,586	5,347	5,000	7,000
Business License-interest	663	46	-	-
Building Permits	63,489	52,977	53,000	80,728
Plumbing & Sewer Permits	8,540	9,091	8,500	16,036
Electrical Permits	24,408	24,408	23,500	26,127
Other Permits	18,405	20,545	20,500	41,709
	<u>1,600,103</u>	<u>1,575,615</u>	<u>1,628,298</u>	<u>1,636,494</u>
Citizens Corps Grant	2,424	667	-	-
Fed Indirect Operating-HUD	180,466	-	-	-
Fed Indirect Operating-HUD	23,447	78,870	-	-
Fed Indirect Operating-HUD	2,553	53,787	-	-
Fed Indirect Operating-HUD	-	39,558	-	-
Police Grants	433,862	402,075	454,793	589,228
Police Dept of Justice Capital Grants	-	5,022	-	-
Police Capital Grants	6,355	-	1,000	1,000
Police Capital Grants	50,000	-	-	-
Other State Grants	2,595	-	-	-
Ride the City Project	18,462	-	-	-
SEMO Reg Planning Comm. Grant	46,303	65,413	-	-
SEMO Reg Planning	-	22,361	-	-
FY 11 Assistance to Firefighters G	(5,113)	893	-	-
FY 12 Assistance to Firefighters G	50,372	-	-	-
County Business Surtax	49,165	49,506	49,165	49,506
	<u>860,891</u>	<u>718,152</u>	<u>504,958</u>	<u>639,734</u>
Misc. Fees-Grave Openings	25,590	32,675	27,500	28,000
Cemetery Plot Sales	11,350	11,585	10,875	11,300
Municipal Court Summons	3,492	2,281	3,500	-
Engineering Fees	2,095	16,755	2,500	17,500
Engineer Fees	15,493	-	13,500	-
Plan Review Fees	25,807	21,871	22,250	21,350

GENERAL FUND REVENUE

	<u>2013-14</u> <u>ACTUAL</u>	<u>2014-15</u> <u>ACTUAL</u>	<u>2015-16</u> <u>BUDGET</u>	<u>2016-17</u> <u>PROPOSED</u>
Rental Inspection Fees	-	-	26,700	87,750
Planning Fees	6,676	4,804	4,500	4,900
Planning Services Fees	1,907	5,711	5,000	4,700
Mosquito Fogging Fees	11,300	-	-	-
Extra Patrol Fees	794	-	-	-
Outside Fire Protection	23,750	23,005	23,000	23,000
Special Event Fees	-	200	-	200
Court Costs	68,618	61,301	80,000	61,000
DWI Recoupment Fee	3,804	4,187	4,500	4,000
	<u>200,676</u>	<u>184,374</u>	<u>223,825</u>	<u>263,700</u>
Municipal Court Fines	613,062	531,059	777,875	530,000
Non Traffic Fines	91,293	131,273	-	123,000
Parking Tickets	37,219	42,606	-	35,000
Returned Check Charge	7,673	7,712	7,680	7,650
	<u>749,246</u>	<u>712,649</u>	<u>785,555</u>	<u>695,650</u>
Interest on Overnight Investments	67,240	69,854	62,500	67,500
Interest on Interfund Advances	17,457	10,656	6,177	3,370
Interest on Taxes from County	5	9	-	-
Interest on Special Assessment	704	987	700	1,000
Office Space Rental	194,015	197,892	201,852	205,889
Railroad Lease	40,761	39,698	39,915	41,762
Special Projects	5,812	8,050	5,800	6,000
Planning Operating Contribution	-	-	36,000	36,000
Accounts Payable Rebates	53,209	46,612	42,000	36,000
General Miscellaneous	30,111	191,202	31,000	40,000
Cash Overages & Shortages	(489)	(689)	-	-
	<u>408,827</u>	<u>564,271</u>	<u>425,944</u>	<u>437,521</u>
Proceeds from Sale of Assets	22,544	21,759	-	12,500
Compensation for Damages	90	33,647	-	-
Advance Repayments	76,249	557,611	55,466	58,273
Demolition Assessment	-	5,200	-	-
Weed Abatements	7,525	20,594	11,500	25,000
	<u>106,409</u>	<u>638,811</u>	<u>66,966</u>	<u>95,773</u>
Project Personnel Costs	954,894	914,194	885,634	901,917
Project Overhead Costs	84,699	87,347	79,950	71,745
Project Equipment Costs	5,201	3,791	5,200	5,200
Tax Collection Fees	20,376	21,563	21,300	22,609
	<u>1,065,170</u>	<u>1,026,895</u>	<u>992,084</u>	<u>1,001,471</u>
Transfer-Motor Fuel Fund	970,000	1,120,000	1,420,000	1,445,000
Transfer-Fleet Maintenance	15,612	15,888	16,168	16,453
Transfer-Employee Benefit Fd	79,221	-	27,597	59,967
Transfer-Fire Sales Tax	2,302,317	2,509,834	2,502,000	2,588,335
Transfer-Public Safety Trust	1,151,159	1,254,917	1,251,000	1,294,115
Transfer-PARKS/STORMWATER-OPER	213,099	277,614	250,845	266,397
Transfer-Debt Service Fund	-	26,335	-	-
	<u>4,731,408</u>	<u>5,204,588</u>	<u>5,467,610</u>	<u>5,670,267</u>
	<u>\$26,529,189</u>	<u>\$27,748,722</u>	<u>\$27,525,577</u>	<u>\$27,989,915</u>

---

THIS PAGE INTENTIONALLY LEFT BLANK

---

GENERAL FUND  
EXPENDITURES BY DIVISION

	2013-2014 <u>ACTUAL</u>	2014-2015 <u>ACTUAL</u>	2015-2016 <u>BUDGET</u>	2016-2017 <u>BUDGET</u>
CITY COUNCIL	\$45,424	\$58,091	\$69,989	\$26,710
CITY MANAGER	323,807	341,008	353,925	480,246
PUBLIC AWARENESS	130,428	138,654	147,792	164,790
CITY ATTORNEY	319,558	317,824	317,085	327,570
HUMAN RESOURCES	330,072	320,013	337,451	341,252
FINANCE	574,940	585,768	618,408	627,608
MUNICIPAL COURT	300,666	302,719	320,635	328,123
FACILITY MAINTENANCE	222,770	244,907	230,501	225,555
PLANNING SERVICES	588,981	593,159	464,840	494,205
INSPECTION SERVICES	469,544	519,457	544,245	546,722
ENGINEERING	1,029,913	1,083,964	1,176,439	1,185,037
POLICE	6,714,976	7,614,298	7,987,220	8,352,974
FIRE	5,941,357	5,306,506	5,392,887	5,446,241
STREET	2,768,604	3,330,408	2,983,506	2,808,035
PARK MAINTENANCE	1,555,772	1,502,854	1,528,336	1,512,081
CEMETERY	187,120	196,836	190,379	193,318
INTERDEPARTMENTAL SERV	4,834,034	5,451,669	4,736,664	4,770,694
CONTINGENCY	5,885	(5,358)	249,654	287,542
TOTAL EXPENDITURES	<u>26,343,851</u>	<u>27,902,777</u>	<u>27,649,956</u>	<u>28,118,703</u>
LESS TRANSFERS	<u>4,366,390</u>	<u>5,118,473</u>	<u>4,371,889</u>	<u>4,413,942</u>
NET EXPENDITURES	<u>\$21,977,461</u>	<u>\$22,784,304</u>	<u>\$23,278,067</u>	<u>\$23,704,761</u>

## City Council

The City Council is the elected legislative authority of the City government. It passes all ordinances, policy documents and other measures conducive to the welfare of the City. The City Council is directly accountable to the citizenry for the conduct of municipal affairs.

## 2016-2017 Proposed Budget General Fund

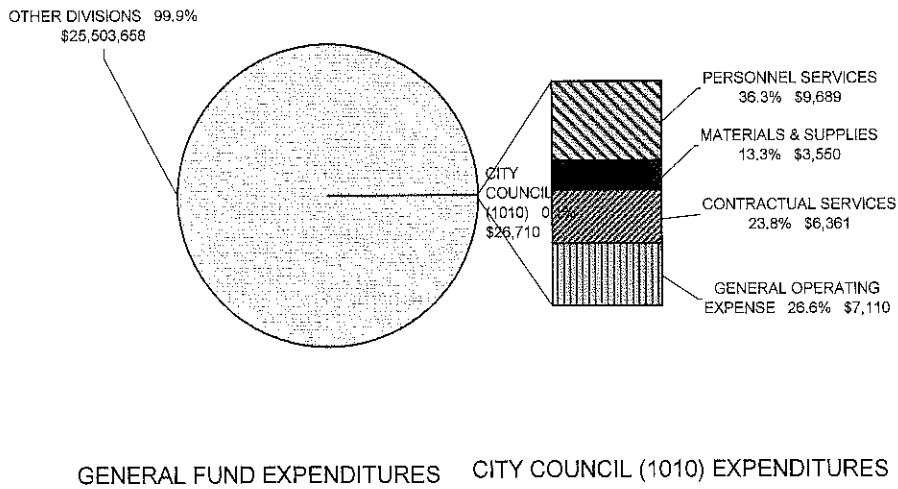

CITY COUNCIL (1010)

BUDGET BY MAJOR OBJECT

	2013-14 <u>ACTUAL</u>	2014-15 <u>ACTUAL</u>	2015-16 <u>BUDGET</u>	2016-17 <u>PROPOSED</u>
PERSONNEL COSTS	\$9,546	\$9,705	\$9,705	\$9,689
MATERIALS AND SUPPLIES	1,465	4,390	4,150	3,550
CONTRACTUAL SERVICES	29,861	39,422	49,274	6,361
GENERAL OPERATIONS	4,552	4,574	6,860	7,110
CAPITAL EXPENDITURES	-	-	-	-
SPECIAL PROJECTS	-	-	-	-
DEBT PAYMENTS	-	-	-	-
TRANSFERS	-	-	-	-
	<u>\$45,424</u>	<u>\$58,091</u>	<u>\$69,989</u>	<u>\$26,710</u>

TOTAL PERSONNEL SERVICE BY POSITION  
CITY COUNCIL

CLASSIFICATION	SALARY GRADE (Details in Appendices)		2015-2016 FISCAL YEAR	2016-2017 FISCAL YEAR
Regular Employees				
Mayor	Grade	N/A	1	1
City Council	Grade	N/A	<u>6</u>	<u>6</u>
TOTAL			7	7

## City Manager

The City Manager is the administrative head of the City government. Under the direction of the City Council, he supervises all City departments, appoints all City employees, achieves goals and objectives established by the City Council, sees that laws ordinances and provisions of the Charter are enforced, enforces terms of public utility franchises, prepares and submits the annual and capital program budgets, advises the City Council of financial affairs, makes appropriate recommendations to the City Council and performs such other duties as prescribed by law and the City Council.

## 2016-2017 Proposed Budget

### General Fund

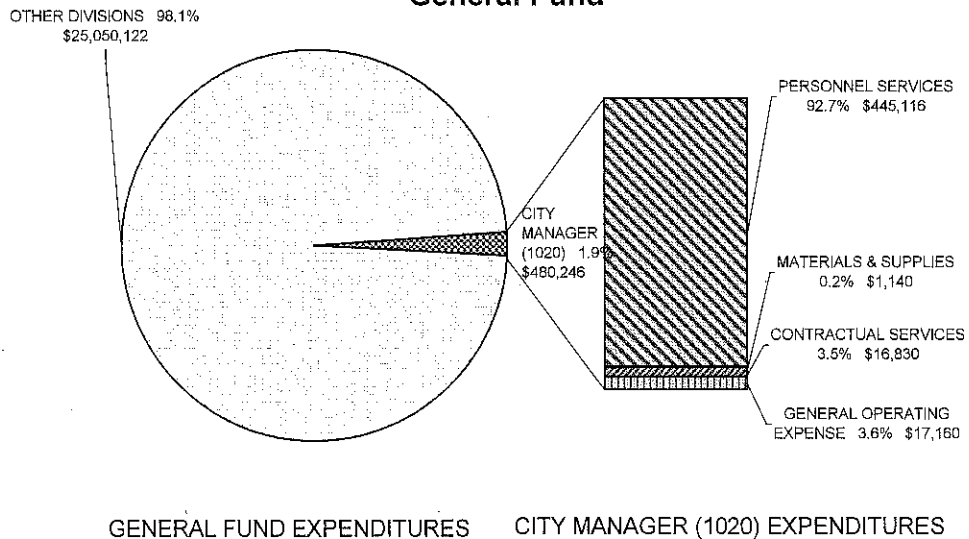

CITY MANAGER (1020)

BUDGET BY MAJOR OBJECT

	2013-14 <u>ACTUAL</u>	2014-15 <u>ACTUAL</u>	2015-16 <u>BUDGET</u>	2016-17 <u>PROPOSED</u>
PERSONNEL COSTS	\$283,497	\$314,836	\$319,171	\$445,116
MATERIALS AND SUPPLIES	2,595	2,675	1,140	1,140
CONTRACTUAL SERVICES	23,010	14,947	16,044	16,830
GENERAL OPERATIONS	14,705	8,550	17,570	17,160
CAPITAL EXPENDITURES	-	-	-	-
SPECIAL PROJECTS	-	-	-	-
DEBT PAYMENTS	-	-	-	-
TRANSFERS	-	-	-	-
	<u>\$323,807</u>	<u>\$341,008</u>	<u>\$353,925</u>	<u>\$480,246</u>

TOTAL PERSONNEL SERVICE BY POSITION  
CITY MANAGER

CLASSIFICATION	SALARY GRADE (Details in Appendices)	2015-2016 FISCAL YEAR	2016-2017 FISCAL YEAR
Regular Employees			
City Manager	Grade N/A	1	1
Deputy City Manager	Grade X	0	1
Director of Citizens Services	Grade U	0.40	0.40
Deputy City Clerk	Grade M	1	1
Administrative Secretary	Grade E	1	1
		<u>3.40</u>	<u>4.40</u>
TOTAL		3.40	4.40



## Public Awareness

The overall goal is to increase citizen knowledge, awareness and confidence in the programs, projects, services, and activities provided by the City. Activities involve interfacing with media sources concerning City issues; handling public information for City departments, coordinating activities with other departments; developing internal and external publications and coordinating Cable Access Channel 993.

### 2016-2017 Proposed Budget General Fund

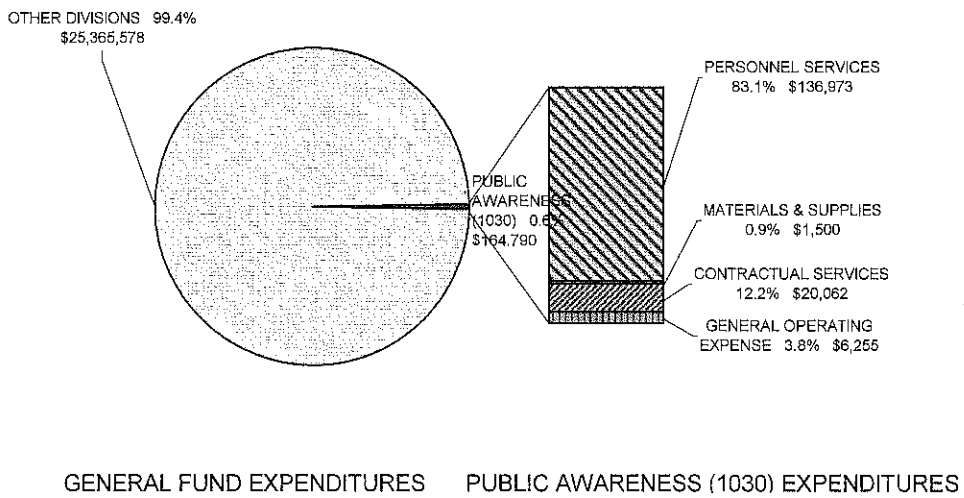

PUBLIC AWARENESS (1030)

BUDGET BY MAJOR OBJECT

	2013-2014 <u>ACTUAL</u>	2014-2015 <u>ACTUAL</u>	2015-2016 <u>BUDGET</u>	2016-2017 <u>PROPOSED</u>
PERSONNEL COSTS	\$115,499	\$123,937	\$125,193	\$136,973
MATERIALS AND SUPPLIES	3,796	1,887	1,740	1,500
CONTRACTUAL SERVICES	6,565	8,256	14,769	20,062
GENERAL OPERATIONS	4,568	4,574	6,090	6,255
CAPITAL EXPENDITURES	-	-	-	-
SPECIAL PROJECTS	-	-	-	-
DEBT PAYMENTS	-	-	-	-
TRANSFERS	-	-	-	-
	<u>\$130,428</u>	<u>\$138,654</u>	<u>\$147,792</u>	<u>\$164,790</u>

TOTAL PERSONNEL SERVICE BY POSITION  
PUBLIC AWARENESS

CLASSIFICATION	SALARY GRADE (Details in Appendices)	2015-2016 FISCAL YEAR	2015-2016 FISCAL YEAR
Regular Employees			
Director of Citizen Services	Grade U	0.15	0.15
Public Information Manager	Grade R	1	1
Public Information Specialist	Grade L	<u>1</u>	<u>1</u>
TOTAL		2.15	2.15

## City Attorney

The City Attorney performs all necessary legal services for and on behalf of the City. Major assignments are to advise the City Council and other City officials of legal matters, to institute and prosecute actions in the Municipal Court as provided by law or ordinances, to prepare ordinances and other legal documents relating to the City affairs and to represent the City's legal interest as required.

### 2016-2017 Proposed Budget General Fund

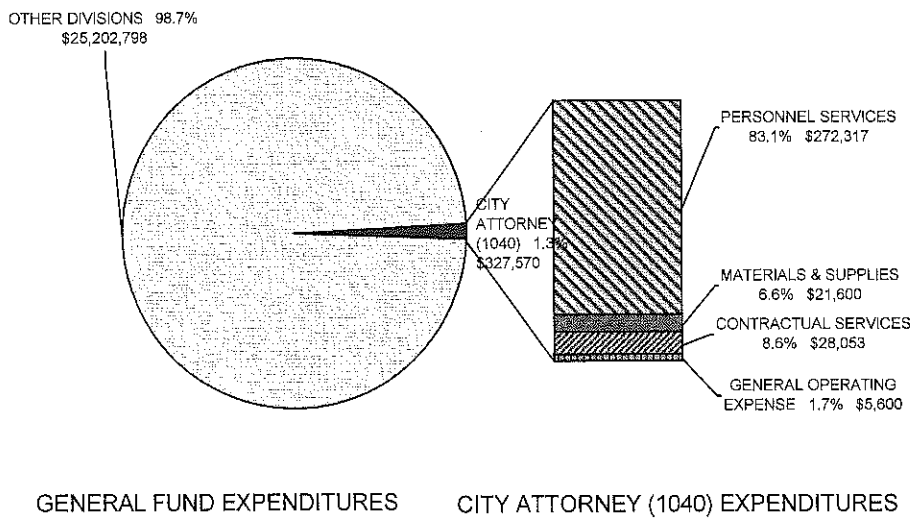

CITY ATTORNEY (1040)

BUDGET BY MAJOR OBJECT

	2013-14 <u>ACTUAL</u>	2014-15 <u>ACTUAL</u>	2015-16 <u>BUDGET</u>	2016-17 <u>PROPOSED</u>
PERSONNEL COSTS	\$255,900	\$265,019	\$269,467	\$272,317
MATERIALS AND SUPPLIES	22,219	21,849	21,600	21,600
CONTRACTUAL SERVICES	37,699	26,356	20,418	28,053
GENERAL OPERATIONS	3,740	4,600	5,600	5,600
CAPITAL EXPENDITURES	-	-	-	-
SPECIAL PROJECTS	-	-	-	-
DEBT PAYMENTS	-	-	-	-
TRANSFERS	-	-	-	-
	<u>\$319,558</u>	<u>\$317,824</u>	<u>\$317,085</u>	<u>\$327,570</u>

TOTAL PERSONNEL SERVICE BY POSITION  
CITY ATTORNEY

CLASSIFICATION	SALARY GRADE (Details in Appendices)		2015-2016 FISCAL YEAR	2016-2017 FISCAL YEAR
Regular Employees				
City Attorney	Grade	V	1	1
Assistant City Attorney	Grade	S	1	1
Legal Secretary	Grade	J	1	1
Administrative Clerk	Grade	D	0.50	0.50
TOTAL			3.50	3.50

## Human Resources Management

This is a division of the City Manager's office responsible for all human resources development and management of the City's efforts to cover, reduce, and/or eliminate all employee safety risks and all City liability/casualty exposures.

## 2016-2017 Proposed Budget

### General Fund

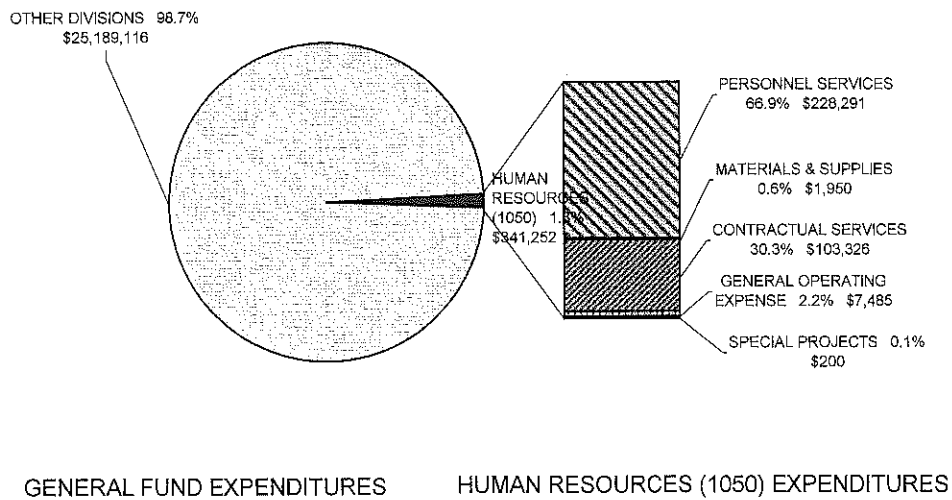

HUMAN RESOURCES (1050)

BUDGET BY MAJOR OBJECT

	2013-14 <u>ACTUAL</u>	2014-15 <u>ACTUAL</u>	2015-16 <u>BUDGET</u>	2016-17 <u>PROPOSED</u>
PERSONNEL COSTS	\$192,475	\$222,787	\$227,454	\$228,291
MATERIALS AND SUPPLIES	1,730	1,633	1,950	1,950
CONTRACTUAL SERVICES	130,988	86,289	95,137	103,326
GENERAL OPERATIONS	4,878	9,304	12,710	7,485
CAPITAL EXPENDITURES	-	-	-	-
SPECIAL PROJECTS	-	-	200	200
DEBT PAYMENTS	-	-	-	-
TRANSFERS	-	-	-	-
	<u>\$330,072</u>	<u>\$320,013</u>	<u>\$337,451</u>	<u>\$341,252</u>

TOTAL PERSONNEL SERVICE BY POSITION  
HUMAN RESOURCES

CLASSIFICATION	SALARY GRADE (Details in Appendices)	2015-2016 FISCAL YEAR	2016-2017 FISCAL YEAR
Regular Employees			
Human Resources Manager	Grade T	1	1
HR Specialist	Grade N	1	1
Fitness Wellness Coordinator	Grade L	0.5	0.5
HR Generalist	Grade L	0	1
Personnel/Benefits Coordinator	Grade K	1	0
TOTAL		3.50	3.50

## Finance

This department is responsible for all accounting and financial functions of the City government including records management, utility billing, revenue collection, licensing, purchasing, disbursements, investments, data processing, budget analysis, and financial reporting.

### 2016-2017 Proposed Budget General Fund

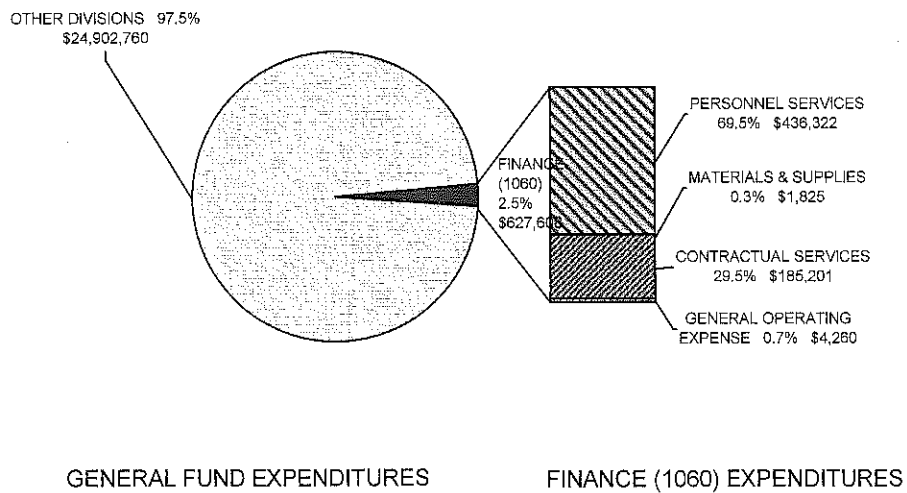

FINANCE (1060)

BUDGET BY MAJOR OBJECT

	2013-14 <u>ACTUAL</u>	2014-15 <u>ACTUAL</u>	2015-16 <u>BUDGET</u>	2016-17 <u>PROPOSED</u>
PERSONNEL COSTS	\$412,573	\$421,788	\$439,289	\$436,322
MATERIALS AND SUPPLIES	2,609	1,178	1,825	1,825
CONTRACTUAL SERVICES	156,886	159,208	173,034	185,201
GENERAL OPERATIONS	2,872	3,594	4,260	4,260
CAPITAL EXPENDITURES	-	-	-	-
SPECIAL PROJECTS	-	-	-	-
DEBT PAYMENTS	-	-	-	-
TRANSFERS	-	-	-	-
	<u>\$574,940</u>	<u>\$585,768</u>	<u>\$618,408</u>	<u>\$627,608</u>

TOTAL PERSONNEL SERVICE BY POSITION  
FINANCE

CLASSIFICATION	SALARY GRADE (Details in Appendices)	2015-2016 FISCAL YEAR	2016-2017 FISCAL YEAR
Regular Employees			
Finance Director/Treasurer	Grade V	1	1
Accounting Manager	Grade P	1	1
Customer Service Manager	Grade P	0.25	0.25
Accountant	Grade M	2	2
Accounts Payable Coordinator	Grade G	1	1
Customer Service Rep.	Grade F	0.50	0.50
Administrative Clerk	Grade D	0.50	0.50
TOTAL		6.25	6.25

Part-Time Employees

	2015-2016		2016-2017	
	<u>Actual Hours</u>	<u>Full-Time Equivalent</u>	<u>Actual Hours</u>	<u>Full-Time Equivalent</u>
Purchasing Coordinator	1300	0.63	1300	0.63



## Municipal Court

The Municipal Court has exclusive original jurisdiction to hear and rule on all complaints under city ordinances. It is empowered to imprison and/or fine any person violating City ordinances.

## 2016-2017 Proposed Budget

### General Fund

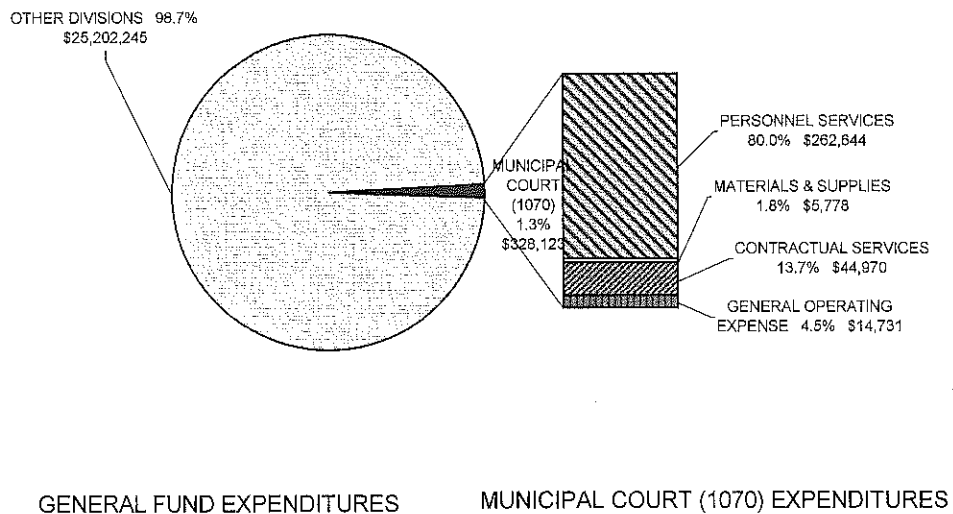

MUNICIPAL COURT (1070)

BUDGET BY MAJOR OBJECT

	2013-14 <u>ACTUAL</u>	2014-15 <u>ACTUAL</u>	2015-16 <u>BUDGET</u>	2016-17 <u>PROPOSED</u>
PERSONNEL COSTS	\$239,851	\$239,438	\$253,217	\$262,644
MATERIALS AND SUPPLIES	6,172	7,848	5,105	5,778
CONTRACTUAL SERVICES	38,047	43,053	45,149	44,970
GENERAL OPERATIONS	16,596	12,380	17,164	14,731
CAPITAL EXPENDITURES	-	-	-	-
SPECIAL PROJECTS	-	-	-	-
DEBT PAYMENTS	-	-	-	-
TRANSFERS	-	-	-	-
	<u>\$300,666</u>	<u>\$302,719</u>	<u>\$320,635</u>	<u>\$328,123</u>

TOTAL PERSONNEL SERVICE BY POSITION  
MUNICIPAL COURT

CLASSIFICATION	SALARY GRADE (Details in Appendices)	2015-2016 FISCAL YEAR	2016-2017 FISCAL YEAR
Regular Employees			
Municipal Judge	EXEMPT	1	1
Chief Court Clerk	Grade M	1	1
Court Clerk	Grade I	1	1
Violations Clerk	Grade F	1	1
Administrative Clerk	Grade D	1	1
TOTAL		5	5

## Facility Maintenance

This division accounts for the costs of maintaining the City Hall, Police Station, and certain areas of all city facilities.

### 2016-2017 Proposed Budget General Fund

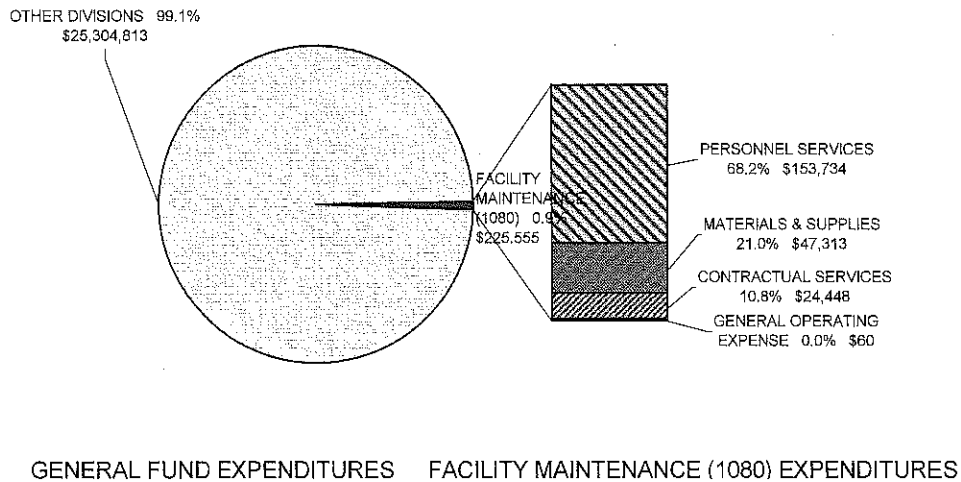

FACILITY MAINTENANCE (1080)

BUDGET BY MAJOR OBJECT

	2013-14 <u>ACTUAL</u>	2014-15 <u>ACTUAL</u>	2015-16 <u>BUDGET</u>	2016-17 <u>PROPOSED</u>
PERSONNEL COSTS	\$150,265	\$154,405	\$151,850	\$153,734
MATERIALS AND SUPPLIES	52,726	45,429	52,888	47,313
CONTRACTUAL SERVICES	19,779	38,092	25,513	24,448
GENERAL OPERATIONS	-	-	250	60
CAPITAL EXPENDITURES	-	6,981	-	-
SPECIAL PROJECTS	-	-	-	-
DEBT PAYMENTS	-	-	-	-
TRANSFERS	-	-	-	-
	<u>\$222,770</u>	<u>\$244,907</u>	<u>\$230,501</u>	<u>\$225,555</u>

TOTAL PERSONNEL SERVICE BY POSITION  
FACILITY MAINTENANCE

CLASSIFICATION	SALARY GRADE (Details in Appendices)		2015-2016 FISCAL YEAR	2016-2017 FISCAL YEAR
Regular Employees				
Facility Maintenance Coord.	Grade	M	1	1
Maintenance Worker	Grade	E	<u>2</u>	<u>2</u>
TOTAL			3	3

## Planning Services

This division is responsible for all City planning, zoning and subdivision development. It is also responsible for coordinating economic development activities, the Community Development Block Grant program, and other activities associated with community development.

## 2016-2017 Proposed Budget

### General Fund

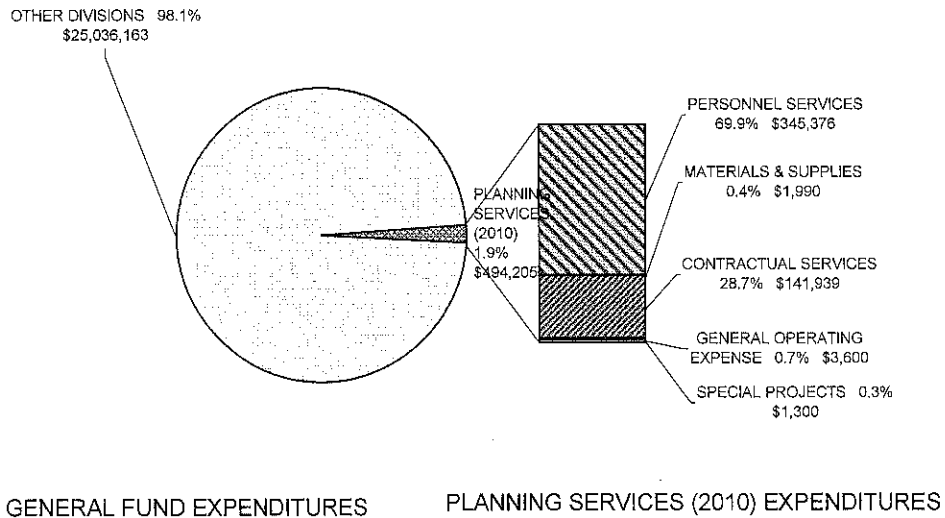

PLANNING SERVICES (2010)

BUDGET BY MAJOR OBJECT

	2013-14 <u>ACTUAL</u>	2014-15 <u>ACTUAL</u>	2015-16 <u>BUDGET</u>	2016-17 <u>PROPOSED</u>
PERSONNEL COSTS	\$276,683	\$274,023	\$319,766	\$345,376
MATERIALS AND SUPPLIES	1,195	1,469	1,328	1,990
CONTRACTUAL SERVICES	69,186	138,259	139,346	141,939
GENERAL OPERATIONS	4,876	3,427	3,400	3,600
CAPITAL EXPENDITURES	-	-	-	-
SPECIAL PROJECTS	237,041	175,981	1,000	1,300
DEBT PAYMENTS	-	-	-	-
TRANSFERS	-	-	-	-
	<u>\$588,981</u>	<u>\$593,159</u>	<u>\$464,840</u>	<u>\$494,205</u>

TOTAL PERSONNEL SERVICE BY POSITION  
PLANNING SERVICES

CLASSIFICATION	SALARY GRADE (Details in Appendices)		2015-2016 FISCAL YEAR	2016-2017 FISCAL YEAR
Regular Employees				
Assistant City Manager - Devl Svc	Grade	W	0.30	0.00
Director of Development Services	Grade	V	0.00	0.33
City Planner	Grade	R	1	1
Housing Asst. Coord.	Grade	M	1	1
Planner	Grade	N/A	1	0
Transportation & Land Use Planner	Grade	L	0	1
Planning Technician	Grade	K	1	1
TOTAL			4.30	4.33

## Inspection Services

This division is responsible for all inspections, interpretation, and enforcement activities required by the International Code Council family of codes adopted by the City.

## 2016-2017 Proposed Budget

### General Fund

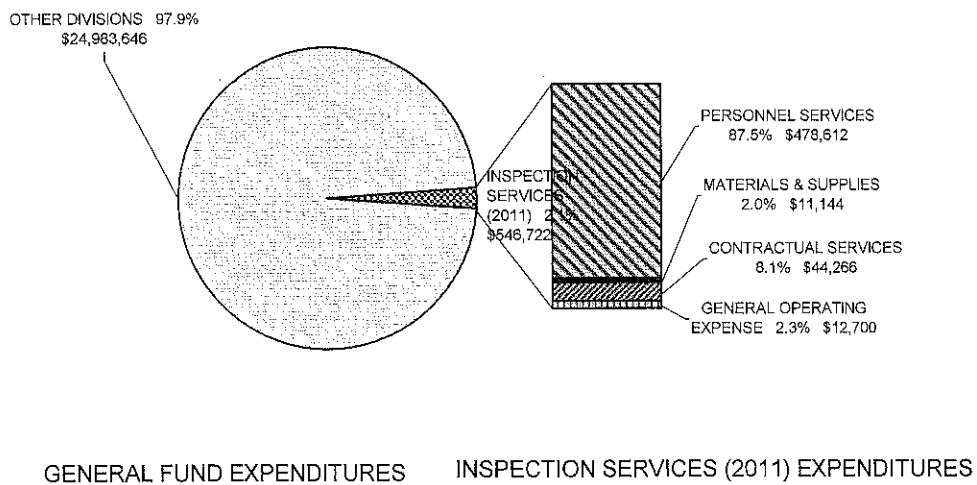

INSPECTION SERVICES (2011)

BUDGET BY MAJOR OBJECT

	2013-14 <u>ACTUAL</u>	2014-15 <u>ACTUAL</u>	2015-16 <u>BUDGET</u>	2016-17 <u>PROPOSED</u>
PERSONNEL COSTS	\$401,663	\$430,243	\$472,307	\$478,612
MATERIALS AND SUPPLIES	10,367	22,181	9,565	11,144
CONTRACTUAL SERVICES	51,728	64,777	51,353	44,266
GENERAL OPERATIONS	5,786	2,256	11,020	12,700
CAPITAL EXPENDITURES	-	-	-	-
SPECIAL PROJECTS	-	-	-	-
DEBT PAYMENTS	-	-	-	-
TRANSFERS	-	-	-	-
	<u>\$469,544</u>	<u>\$519,457</u>	<u>\$544,245</u>	<u>\$546,722</u>

TOTAL PERSONNEL SERVICE BY POSITION  
INSPECTION SERVICES

CLASSIFICATION	SALARY GRADE (Details in Appendices)	2015-2016 FISCAL YEAR	2016-2017 FISCAL YEAR
Regular Employees			
Assistant City Manager-Devl Svces	Grade W	0.30	0.00
Director Development Services	Grade V	0	0.33
Building and Code Enforcement Mgr	Grade R	1	1
Plan Review Specialist I	Grade Q	1	1
Senior Code Inspector	Grade O	1	1
Code Inspector	Grade L	2	1
Property Mntc/Rental Inspector	Grade L	0	1
Property Mntc/Zoning Inspector	Grade L	1	1
Permit Technician	Grade F	1	1
Temporary Administrative Clerk	Grade D	1	1
		<u>8.30</u>	<u>8.33</u>
TOTAL		8.30	8.33



# Engineering

This division provides engineering design services for some City construction projects, reviews private development designs and construction in accordance with ordinances and other policy statements by the City Council, keeps the necessary records, and performs other such engineering assignments and duties as required.

## 2016-2017 Proposed Budget

### General Fund

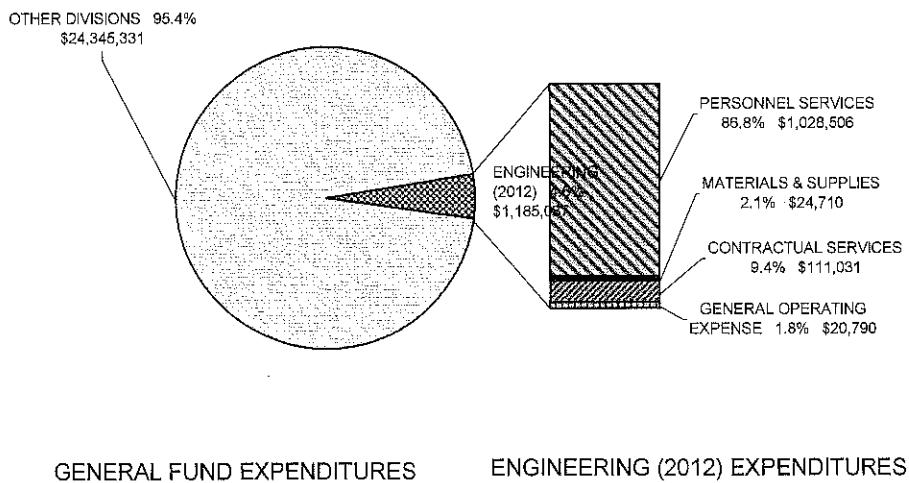

ENGINEERING (2012)

BUDGET BY MAJOR OBJECT

	2013-14 <u>ACTUAL</u>	2014-15 <u>ACTUAL</u>	2015-16 <u>BUDGET</u>	2016-17 <u>PROPOSED</u>
PERSONNEL COSTS	\$904,020	\$946,954	\$1,030,754	\$1,028,506
MATERIALS AND SUPPLIES	21,924	21,597	25,621	24,710
CONTRACTUAL SERVICES	95,151	95,920	104,799	111,031
GENERAL OPERATIONS	8,818	12,672	15,265	20,790
CAPITAL EXPENDITURES	-	6,821	-	-
SPECIAL PROJECTS	-	-	-	-
DEBT PAYMENTS	-	-	-	-
TRANSFERS	-	-	-	-
	<u>\$1,029,913</u>	<u>\$1,083,964</u>	<u>\$1,176,439</u>	<u>\$1,185,037</u>

TOTAL PERSONNEL SERVICE BY POSITION  
ENGINEERING

CLASSIFICATION	SALARY GRADE (Details in Appendices)	2015-2016 FISCAL YEAR	2016-2017 FISCAL YEAR
Regular Employees			
Assistant City Manager - Devl Svces	Grade W	0.30	0
Director Development Services	Grade V	0	0.33
City Engineer	Grade T	1	1
Civil Engineer II	Grade R	1	1
Assistant City Engineer	Grade Q	1	1
Civil Engineer I	Grade P	1	1
Chief Construction Inspector	Grade P	1	1
Survey Crew Chief	Grade N	1	1
Sr. Construction Inspector	Grade N	2	2
Construction Inspector	Grade M	2	2
Engineering Technician	Grade L	2	2
Project Specialist	Grade J	2	2
Administrative Coordinator	Grade J	1	1
<b>TOTAL</b>		<u>15.30</u>	<u>15.33</u>

Part-Time Employees

	2015-2016		2016-2017	
	<u>Actual Hours</u>	<u>Full-Time Equivalent</u>	<u>Actual Hours</u>	<u>Full-Time Equivalent</u>
Engineering Technician	520	0.25	520	0.25
Constr. Inspector	1,600	0.77	1,600	0.77
Property Acquisition Agent	<u>1,456</u>	<u>0.70</u>	<u>1,456</u>	<u>0.70</u>
	3,576	1.72	3,576	1.72

## Police

The Police Department maintains the public peace, suppresses crime, enforces traffic and other City ordinances, executes warrants and other processes issued by the Municipal Court and City Attorney, and performs related duties. The Crime Prevention Program is a major effort of the department.

## 2016-2017 Proposed Budget

### General Fund

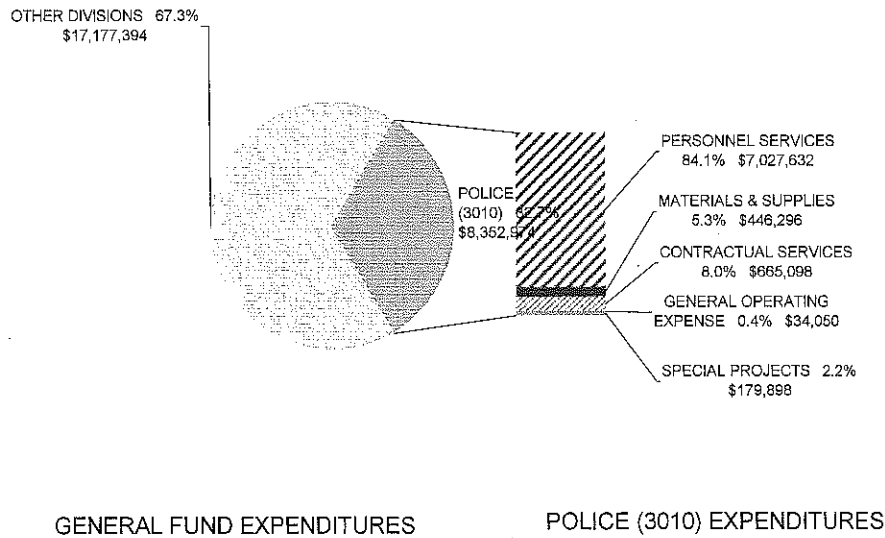

POLICE (3010)

BUDGET BY MAJOR OBJECT

	2013-14 <u>ACTUAL</u>	2014-15 <u>ACTUAL</u>	2015-16 <u>BUDGET</u>	2016-17 <u>PROPOSED</u>
PERSONNEL COSTS	\$5,455,282	\$6,311,044	\$6,723,714	\$7,027,632
MATERIALS AND SUPPLIES	481,816	501,176	430,641	446,296
CONTRACTUAL SERVICES	554,478	606,816	625,515	665,098
GENERAL OPERATIONS	31,222	49,015	26,350	34,050
CAPITAL EXPENDITURES	81,478	15,580	-	-
SPECIAL PROJECTS	110,700	130,667	181,000	179,898
DEBT PAYMENTS	-	-	-	-
TRANSFERS	-	-	-	-
	<u>\$6,714,976</u>	<u>\$7,614,298</u>	<u>\$7,987,220</u>	<u>\$8,352,974</u>

TOTAL PERSONNEL SERVICE BY POSITION  
POLICE

CLASSIFICATION	SALARY GRADE (Details in Appendices)	2015-2016 FISCAL YEAR	2016-2017 FISCAL YEAR
Regular Employees			
Police Chief	Grade LL	1	1
Assistant Police Chief	Grade KK	2	2
Lieutenant	Grade II	5	5
Sergeant	Grade FF	8	8
Corporal	Grade EE	10	10
Patrolman	Grade CC	49	52
Bailiff	Grade CC	1	1
Communications Supervisor	Grade M	1	1
Records Supervisor	Grade L	1	1
Property Evidence Tech	Grade J	1	1
Lead Communications Officer	Grade I	3	3
Station Commander	Grade H	2	2
Communications Officer	Grade G	9	9
Jailer	Grade G	6	6
Administrative Coordinator	Grade G	0	1
Administrative Assistant	Grade F	1	1
Nuisance Abatement Officer	Grade F	1	1
Administrative Secretary	Grade E	1	0
Records Clerk	Grade D	4	4
CTSP Co -Coordinators	Grade N/A	2	2
TOTAL		108	111

Part-Time Employees

	2015-2016		2016-2017	
	<u>Actual Hours</u>	<u>Full-Time Equivalent</u>	<u>Actual Hours</u>	<u>Full-Time Equivalent</u>
Clerical Assistant	1040	0.50	1000	0.48
Communicators	2000	0.96	2000	0.96
	<u>3040</u>	<u>1.46</u>	<u>3000</u>	<u>1.44</u>

## Fire

The major emphasis of this department will continue to be fire prevention and enforcement of the fire code, suppressing fires, together with providing first response emergency medical service, and performance of related duties.

## 2016-2017 Proposed Budget

### General Fund

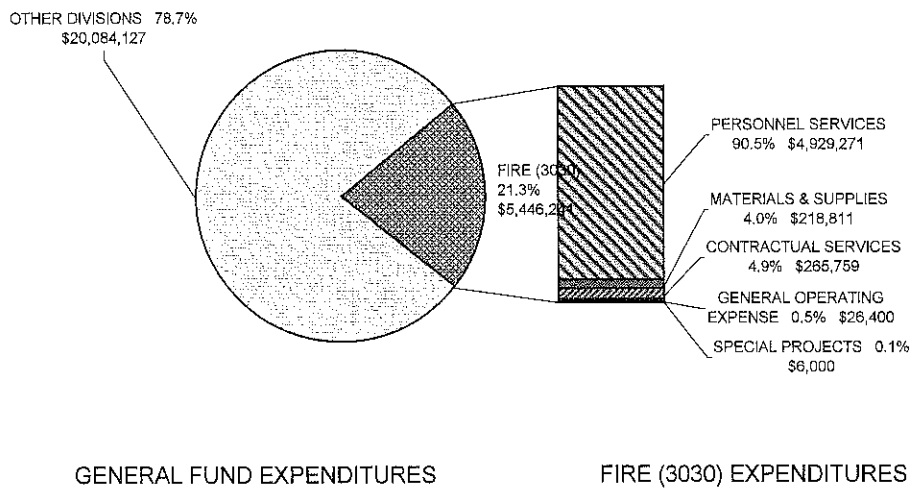

GENERAL FUND EXPENDITURES

FIRE (3030) EXPENDITURES

FIRE (3030)

BUDGET BY MAJOR OBJECT

	2013-14 <u>ACTUAL</u>	2014-15 <u>ACTUAL</u>	2015-16 <u>BUDGET</u>	2016-17 <u>PROPOSED</u>
PERSONNEL COSTS	\$5,270,543	\$4,707,286	\$4,840,723	\$4,929,271
MATERIALS AND SUPPLIES	324,126	233,139	224,596	218,811
CONTRACTUAL SERVICES	273,320	262,871	295,168	265,759
GENERAL OPERATIONS	23,296	31,241	26,400	26,400
CAPITAL EXPENDITURES	36,288	65,390	-	-
SPECIAL PROJECTS	13,784	6,579	6,000	6,000
DEBT PAYMENTS	-	-	-	-
TRANSFERS	-	-	-	-
	<u>\$5,941,357</u>	<u>\$5,306,506</u>	<u>\$5,392,887</u>	<u>\$5,446,241</u>

TOTAL PERSONNEL SERVICE BY POSITION  
FIRE

CLASSIFICATION	SALARY GRADE (Details in Appendices)		2015-2016 FISCAL YEAR	2016-2017 FISCAL YEAR
Regular Employees				
Fire Chief	Grade	LL	1	1
Assistant Chief/Emergency Mgmt Coord.	Grade	KK	1	1
Battalion Chief	Grade	II	5	5
Captain	Grade	FF	15	15
Captain FSI	Grade	FF	1	1
Master Firefighter	Grade	EE	12	12
Firefighter	Grade	CC	27	27
Mechanic/Maintenance Officer	Grade	L	1	1
Administrative Coordinator	Grade	J	1	1
Administrative Secretary	Grade	E	1	1
TOTAL			<u>65</u>	<u>65</u>

## Street

This division maintains some 200 miles of public streets and right-of-ways. The division installs and maintains traffic markings, signs and signals, works with storm water drainage on public right-of-ways and performs construction and other duties related to street maintenance.

## 2016-2017 Proposed Budget

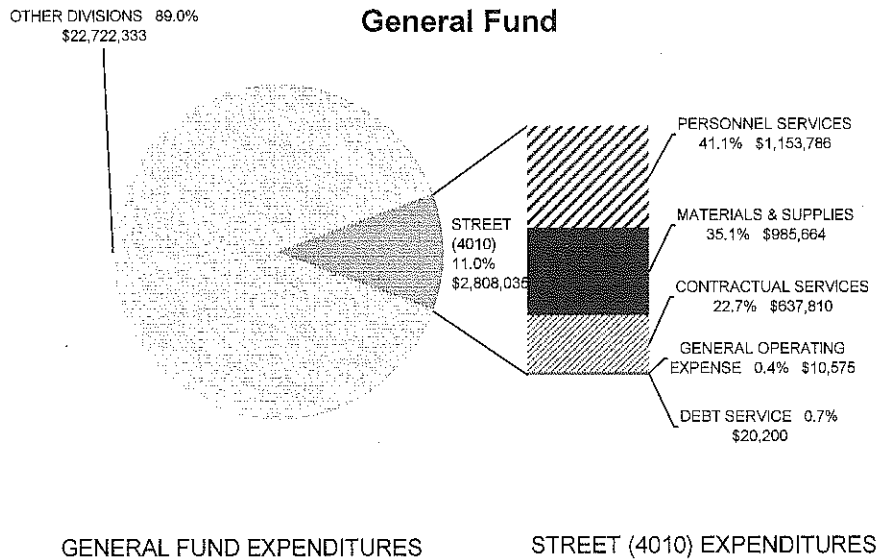

STREET (4010)

BUDGET BY MAJOR OBJECT

	2013-14 <u>ACTUAL</u>	2014-15 <u>ACTUAL</u>	2015-16 <u>BUDGET</u>	2016-17 <u>PROPOSED</u>
PERSONNEL COSTS	\$1,145,602	\$1,156,511	\$1,180,181	\$1,153,786
MATERIALS AND SUPPLIES	846,488	1,031,824	1,074,728	985,664
CONTRACTUAL SERVICES	567,118	664,439	592,210	637,810
GENERAL OPERATIONS	25,468	41,466	8,400	10,575
CAPITAL EXPENDITURES	26,580	7,972	-	-
SPECIAL PROJECTS	-	-	-	-
DEBT PAYMENTS	157,348	428,196	127,987	20,200
TRANSFERS	-	-	-	-
	<u>\$2,768,604</u>	<u>\$3,330,408</u>	<u>\$2,983,506</u>	<u>\$2,808,035</u>

TOTAL PERSONNEL SERVICE BY POSITION  
STREET

CLASSIFICATION	SALARY GRADE (Details in Appendices)	2015-2016 FISCAL YEAR	2016-2017 FISCAL YEAR
Regular Employees			
Public Works Director	Grade V	0.20	0.20
Traffic Operations Engineer	Grade S	1	1
Special Projects Coord.	Grade N	1	1
Street Maintenance Superintendent	Grade M	1	1
Street Maintenance Crew LI	Grade L	2	2
PW System/GIS Analyst	Grade L	0.125	0.125
Traffic Control Technician	Grade I	1	1
Equipment Operator	Grade I	4	4
Street Maintenance Technician	Grade J	1	1
Street Maintenance Worker II	Grade G	8	8
Street/Stormwater Inspector	Grade K	0.5	0.5
Street Maintenance Worker	Grade E	2	2
TOTAL		<u>21.825</u>	<u>21.825</u>

Part-Time Employees

	2015-2016		2016-2017	
	<u>Actual Hours</u>	<u>Full-Time Equivalent</u>	<u>Actual Hours</u>	<u>Full-Time Equivalent</u>
General Worker	<u>2,040</u>	<u>0.98</u>	<u>2,040</u>	<u>0.98</u>
	2,040	0.98	2,040	0.98



## Park Maintenance

This division maintains and operates all public parks, buildings, medians, and areas around other public buildings and recreational facilities.

## 2016-2017 Proposed Budget

### General Fund

OTHER DIVISIONS 94.1%  
\$24,018,287

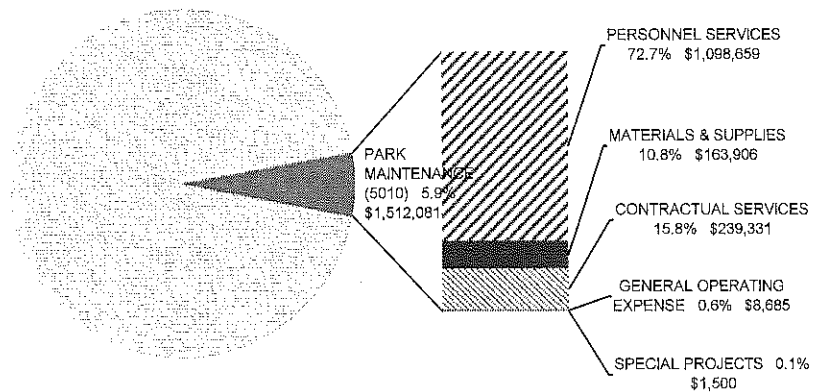

GENERAL FUND EXPENDITURES

PARK MAINTENANCE (5010) EXPENDITURES

PARK MAINTENANCE (5010)

BUDGET BY MAJOR OBJECT

	2013-14 <u>ACTUAL</u>	2014-15 <u>ACTUAL</u>	2015-16 <u>BUDGET</u>	2016-17 <u>PROPOSED</u>
PERSONNEL COSTS	\$1,081,690	\$1,058,849	\$1,084,079	\$1,098,659
MATERIALS AND SUPPLIES	183,491	175,245	183,383	163,906
CONTRACTUAL SERVICES	241,829	240,403	252,189	239,331
GENERAL OPERATIONS	46,112	15,191	7,585	8,685
CAPITAL EXPENDITURES	-	12,166	-	-
SPECIAL PROJECTS	2,650	1,000	1,100	1,500
DEBT PAYMENTS	-	-	-	-
TRANSFERS	-	-	-	-
	<u>\$1,555,772</u>	<u>\$1,502,854</u>	<u>\$1,528,336</u>	<u>\$1,512,081</u>

TOTAL PERSONNEL SERVICE BY POSITION  
PARK MAINTENANCE

CLASSIFICATION	SALARY GRADE (Details in Appendices)	2015-2016 FISCAL YEAR	2016-2017 FISCAL YEAR
Regular Employees			
Director of Parks & Recreation	Grade V	1	1
Parks Division Manager	Grade S	1	1
Parks Supervisor	Grade O	1	1
Parks Crew Leader	Grade L	2	2
Administrative Coordinator	Grade J	1	1
Sr. Maintenance Worker	Grade I	5	5
Maintenance Worker II	Grade G	2	5
Maintenance Worker	Grade E	4	1
Administrative Secretary	Grade E	1	1
TOTAL		18	18

Part-Time Employees

	2015-2016		2016-2017	
	<u>Actual Hours</u>	<u>Full-Time Equivalent</u>	<u>Actual Hours</u>	<u>Full-Time Equivalent</u>
Park Keepers	11,680	5.62	11,680	5.62
Office Worker	1,328	0.64	1,328	0.64
	13,008	6.25	13,008	6.25

## Cemetery

This division operates and maintains three cemetery facilities within the community.

### 2016-2017 Proposed Budget General Fund

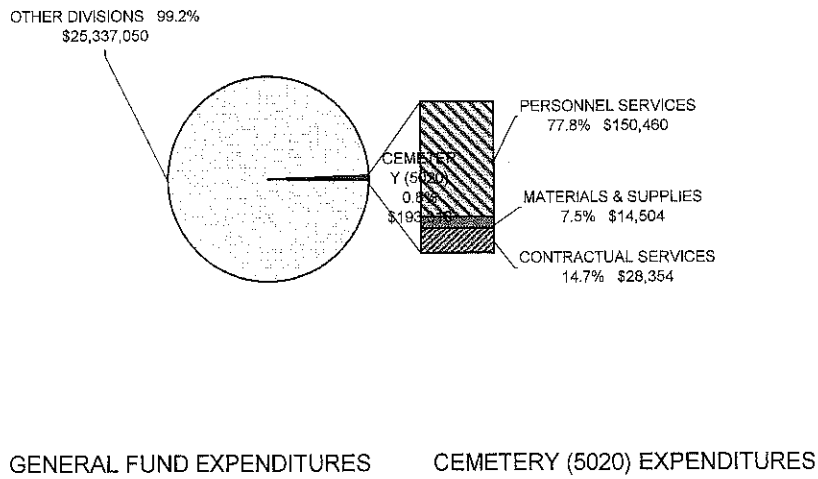

CEMETERY (5020)

BUDGET BY MAJOR OBJECT

	2013-14 <u>ACTUAL</u>	2014-15 <u>ACTUAL</u>	2015-16 <u>BUDGET</u>	2016-17 <u>PROPOSED</u>
PERSONNEL COSTS	\$152,464	\$148,340	\$151,531	\$150,460
MATERIALS AND SUPPLIES	16,465	18,114	17,852	14,504
CONTRACTUAL SERVICES	18,111	30,382	20,996	28,354
GENERAL OPERATIONS	80	-	-	-
CAPITAL EXPENDITURES	-	-	-	-
SPECIAL PROJECTS	-	-	-	-
DEBT PAYMENTS	-	-	-	-
TRANSFERS	-	-	-	-
	<u>\$187,120</u>	<u>\$196,836</u>	<u>\$190,379</u>	<u>\$193,318</u>

TOTAL PERSONNEL SERVICE BY POSITION  
CEMETERY

CLASSIFICATION	SALARY RANGE (Details in Appendices)		2015-2016	2016-2017
			FISCAL YEAR	FISCAL YEAR
Regular Employees				
Sexton	Grade	N	1	1
Maintenance Worker II	Grade	G	<u>1</u>	<u>1</u>
TOTAL			2	2
Part-Time Employees				
	2015-2016		2016-2017	
	<u>Actual</u>	<u>Full-Time</u>	<u>Actual</u>	<u>Full-Time</u>
	<u>Hours</u>	<u>Equivalent</u>	<u>Hours</u>	<u>Equivalent</u>
Seasonal Worker	<u>4,120</u>	<u>1.98</u>	<u>4,120</u>	<u>1.98</u>
	4,120	1.98	4,120	1.98

**INTERDEPARTMENTAL SERVICES**

**BUDGET BY MAJOR OBJECT**

	2013-14 <u>ACTUAL</u>	2014-15 <u>ACTUAL</u>	2015-16 <u>BUDGET</u>	2016-17 <u>PROPOSED</u>
PERSONNEL COSTS	\$ -	\$ -	\$ -	\$ -
MATERIALS AND SUPPLIES	14,004	13,280	13,843	12,174
CONTRACTUAL SERVICES	104,290	105,391	103,062	112,098
GENERAL OPERATIONS	28,378	28,775	29,800	29,600
CAPITAL EXPENDITURES	-	-	-	-
SPECIAL PROJECTS	320,972	185,750	218,070	202,880
DEBT PAYMENTS	-	-	-	-
TRANSFERS	<u>4,366,390</u>	<u>5,118,473</u>	<u>4,371,889</u>	<u>4,413,942</u>
	<u>\$4,834,034</u>	<u>\$5,451,669</u>	<u>\$4,736,664</u>	<u>\$4,770,694</u>

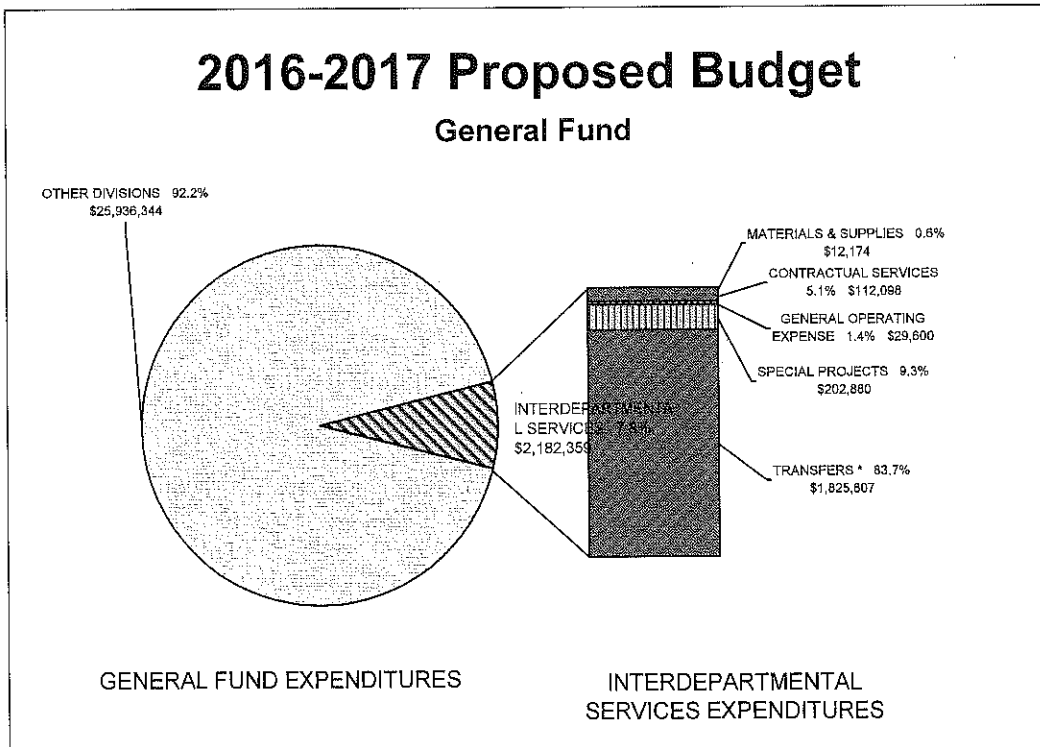

\* Excludes \$2,588,335 pass-through transfers

CONTINGENCY (8000)

BUDGET BY MAJOR OBJECT

	2013-14 <u>ACTUAL</u>	2014-15 <u>ACTUAL</u>	2015-16 <u>BUDGET</u>	2016-17 <u>PROPOSED</u>
PERSONNEL COSTS	\$ -	\$ -	\$ 119,654	\$ 157,542
MATERIALS AND SUPPLIES	-	-	-	-
CONTRACTUAL SERVICES	-	-	50,000	50,000
GENERAL OPERATIONS	3,420	(5,358)	50,000	50,000
CAPITAL EXPENDITURES	-	-	-	-
SPECIAL PROJECTS	2,465	-	30,000	30,000
DEBT PAYMENTS	-	-	-	-
TRANSFERS	-	-	-	-
	<u>\$5,885</u>	<u>(\$5,358)</u>	<u>\$249,654</u>	<u>\$287,542</u>

---

THIS PAGE INTENTIONALLY LEFT BLANK

---

---

## **SPECIAL REVENUE FUNDS BUDGET HIGHLIGHTS**

Special Revenue Funds account for receipts from revenue sources that have been earmarked for specific purposes. Revenue funds are administered by various City departments and including the following funds.

- Airport Fund
- Parks and Recreation Fund
  - Arena Maintenance
  - Osage Park
  - Shawnee Park Community Center
  - Central Pool
  - Family Aquatic Center
  - Recreation
  - Municipal Band
- Health Fund
- Convention and Tourism Fund
- Downtown Business District Fund
- Public Safety Trust Fund
- Public Safety Trust Fund II
- Casino Revenue Fund
- Riverfront Region Economic Development
- Housing Development Grants
- Motor Fuel Tax Fund
- Transportation Sales Tax Trust Fund
- Transportation Sales Tax Trust Fund II
- Transportation Sales Tax Trust Fund III
- Transportation Sales Tax Trust Fund IV
- Transportation Sales Tax Trust Fund V
- Capital Improvement Sales Tax Fund - Water Projects
- Capital Improvement Sales Tax Fund - Sewer System Improvements
- Fire Sales Tax Fund
- Park/Stormwater Sales Tax-Capital
- Park/Stormwater Sales Tax-Operating



---

THIS PAGE INTENTIONALLY LEFT BLANK

---

## SPECIAL REVENUE FUNDS 2016-2017 RESOURCES

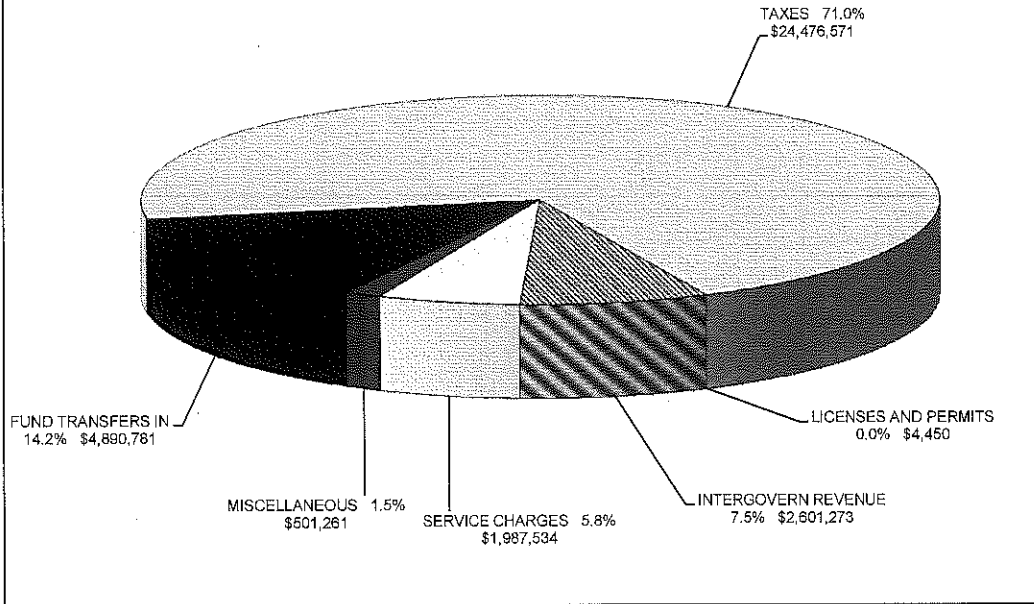

## SPECIAL REVENUE FUNDS 2016-2017 EXPENDITURES

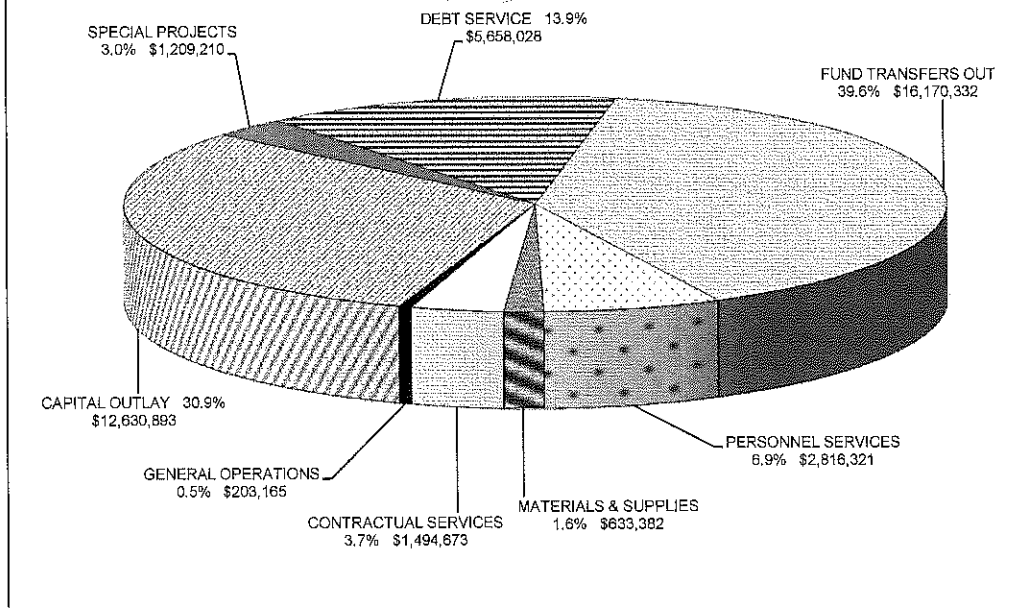

City of Cape Girardeau, Missouri  
 COMBINED STATEMENT OF REVENUES COLLECTED, EXPENDITURES PAID  
 AND CHANGES IN FUND BALANCES - SPECIAL REVENUE FUNDS  
 AIRPORT, PARK/REC, HEALTH, CONV/TOURISM, DOWNTOWN BUS. DIST.,  
 PUBLIC SAFETY TRUST, PUBLIC SAFETY TRUST II, CASINO REVENUE FUND,  
 RIVERFRONT REGION ECONOMIC DEVL FUND, HOUSING DEVELOPMENT GRANTS, MOTOR FUEL,  
 TRANSP SALES TAX, TRANSP SALES TAX II, TRANSP SALES TAX III, TRANSP SALES TAX IV,  
 CAP IMP SALES TAX-WATER PROJECTS, CAP IMP SALES TAX-SEWER SYSTEM IMPR, FIRE SALES TAX  
 PARK/STORMWATER SALES TAX-CAPITAL & PARK/STORMWATER SALES TAX-OPERATIONS

	2013-14 <u>ACTUAL</u>	2014-15 <u>ACTUAL</u>	2015-16 <u>BUDGET</u>	2016-17 <u>PROPOSED</u>
REVENUES COLLECTED:				
TAXES	\$ 22,541,216	\$23,493,624	\$ 21,930,699	\$24,476,571
LICENSES AND PERMITS	4,491	2,512	4,478	4,450
INTERGOVERN REVENUE	1,918,863	2,092,501	1,796,210	2,601,273
SERVICE CHARGES	1,699,335	2,300,172	1,677,760	1,987,534
FINES AND FORFEITS	-	-	-	-
MISCELLANEOUS	564,208	727,346	487,856	501,261
OTHER FINANCING	<u>121,177</u>	<u>4,806</u>	<u>4,468</u>	<u>-</u>
TOTAL REVENUE	\$ 26,849,290	\$28,620,961	\$ 25,901,471	\$29,571,089
EXPENSE OBJECT:				
PERSONNEL SERVICES	\$ 2,565,933	\$ 2,640,904	\$ 2,733,011	\$ 2,816,321
MATERIALS & SUPPLIES	699,798	728,249	715,469	633,382
CONTRACTUAL SERVICES	1,231,936	1,533,713	1,347,072	1,494,673
GENERAL OPERATIONS	135,855	118,066	165,329	203,165
CAPITAL OUTLAY	3,646,627	5,810,486	12,038,119	12,630,893
SPECIAL PROJECTS	2,325,558	1,694,087	1,104,065	1,209,210
DEBT SERVICE	<u>3,724,272</u>	<u>4,404,042</u>	<u>3,010,439</u>	<u>5,658,028</u>
TOTAL EXPENSES	\$ 14,329,978	\$ 16,929,546	\$ 21,113,504	\$24,645,672
FUND TRANSFERS IN	4,669,930	5,031,530	4,894,293	4,890,781
FUND TRANSFERS OUT	7,786,861	12,254,435	20,569,827	16,170,332
PROJECTED REVENUE OVER(UNDER) BUDGET			3,314,467	-
PROJECTED EXPENDITURES UNDER(OVER) BUDGET			(1,787,854)	-
RESERVED FUND BALANCE DECREASE(INCREASE)			-	-
EMERGENCY RESERVE FUND BALANCE DECREASE(INCREASE)			420	(134,063)
BEGINNING UNRESERVED FUND BALANCE			29,548,597	20,188,063
ENDING UNRESERVED FUND BALANCE			<u>20,188,063</u>	<u>13,699,866</u>
EMERGENCY RESERVE FUND			<u>579,153</u>	<u>713,216</u>

---

# **AIRPORT FUND**

---

**AIRPORT FUND  
BUDGET HIGHLIGHTS**

**ACTIVITIES**

The Airport Fund accounts for the operation and maintenance of the municipal airport facility in accordance with Federal Aviation Administration regulations. The airport provides a service facility for passenger traffic, private and commercial aircraft, and related business activities. Additionally, the City operates the Airport's fueling operations.

**SIGNIFICANT OPERATING CHANGES**

Net margin from Airport's FBO fuel sales are projected to increase \$31,830 (10.1%) from the previous year's budget. This reflects projected activity for the fiscal year ending June 30, 2016.

Lease revenue is projected to increase \$14,904 (5.3%) over the previous year's budget. This reflects projected activity for the fiscal year ending June 30, 2016.

Landing fee revenue is projected to increase \$51,699 (544.2%) over the previous year's budget. This includes a landing fee rate increase from \$8.70 to \$51.75 and reflects projected landings for the fiscal year ending June 30, 2016.

This budget includes an addition 1,772 hours for part-time employees at a projected cost of \$17,814. This corrects hours approved for the previous year's budget.

**SIGNIFICANT ONE-TIME EXPENDITURES**

This budget includes \$20,000 for replacement of the chilling tube of the terminal building air conditioning unit, \$30,000 for general capital improvements, \$30,000 for enhancement to baggage handling system, \$16,000 for a flex wing mowing attachment, \$35,000 for a fork lift, and \$8,506 for other small equipment.

This budget also includes one-time grant funded expenditures that are 90% covered by grants. \$750,000 and \$100,000 are included for a fire / rescue vehicle and air service related advertising costs, respectively.

**REVENUE/EXPENDITURE PROJECTIONS**

Revenues, excluding interest, grant revenue, and FBO sales, are projected to increase at 3% over the 5-year period. Net profit margin from FBO sales are maintained at year ending June 30, 2017 levels over the remaining five years. Operating expenses, excluding personnel expenses are projected to grow at the rate of inflation. Personnel expenditures are projected to include wage increases equal to the inflation rate in the fiscal years after June 30, 2017 and an annual turnover rate of 5%. Costs for health and dental insurance are projected to grow 6% and 3% annually, respectively, during these years. No capital outlays are projected since General Fund transfers would support any capital outlays.

## AIRPORT FUND 2016-2017 RESOURCES

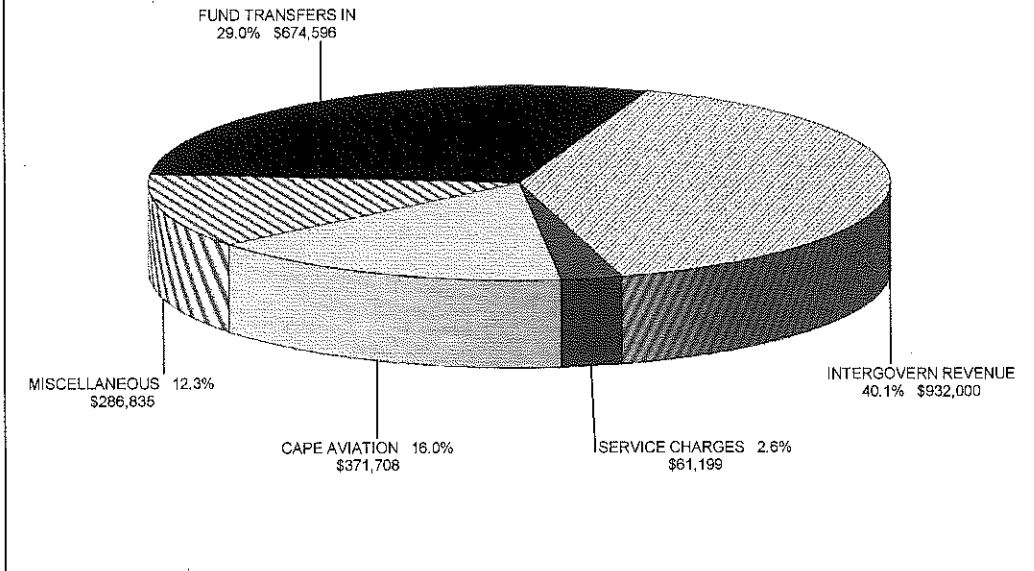

## AIRPORT FUND 2016-2017 EXPENDITURES

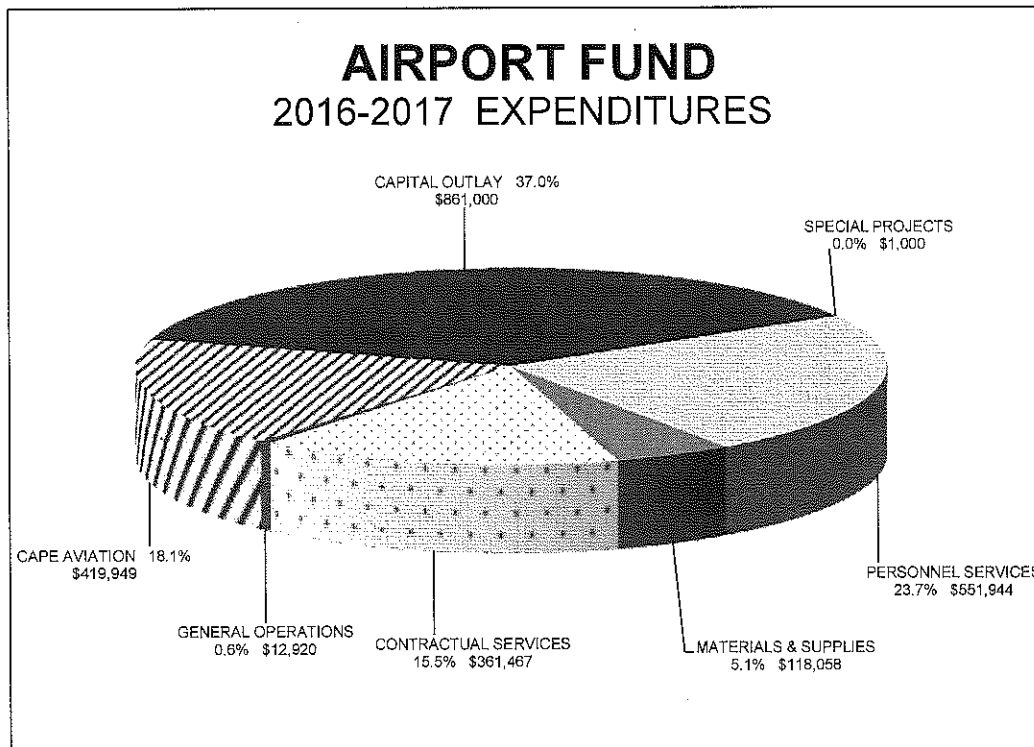

AIRPORT FUND  
BUDGET BY MAJOR OBJECT

	2013-14 <u>ACTUAL</u>	2014-15 <u>ACTUAL</u>	2015-16 <u>BUDGET</u>	2016-17 <u>BUDGET</u>
REVENUE SOURCE:				
TAXES	\$ -	\$ -	\$ -	\$ -
LICENSES AND PERMITS	-	-	-	-
INTERGOVERN REVENUE	209,929	280,548	167,000	932,000
SERVICE CHARGES	519,851	982,477	330,295	418,799
FINES AND FORFEITS	-	-	-	-
MISCELLANEOUS	259,740	282,025	286,339	300,943
OTHER FINANCING	-	-	-	-
	<hr/>	<hr/>	<hr/>	<hr/>
TOTAL REVENUE	\$ 989,520	\$ 1,545,050	\$ 783,634	\$ 1,651,742
EXPENSE OBJECT:				
PERSONNEL SERVICES	\$787,962	\$804,767	\$809,726	\$825,432
MATERIALS & SUPPLIES	167,970	172,205	173,045	161,582
CONTRACTUAL SERVICES	320,594	452,188	374,587	455,704
GENERAL OPERATIONS	28,492	16,065	18,520	21,620
CAPITAL OUTLAY	710	20,493	50,000	861,000
SPECIAL PROJECTS	192,646	48	1,000	1,000
DEBT SERVICE	-	120	-	-
	<hr/>	<hr/>	<hr/>	<hr/>
TOTAL EXPENSES	\$1,498,374	\$1,465,886	\$1,426,878	\$2,326,338
FUND TRANSFERS IN	485,952	543,950	643,244	674,596
FUND TRANSFERS OUT	-	-	-	-
PROJECTED REVENUE OVER(UNDER) BUDGET			295,496	
PROJECTED EXPENDITURES UNDER(OVER) BUDGET			(295,496)	
RESERVED FUND BALANCE DECREASE(INCREASE)				
EMERGENCY RESERVE FUND BALANCE DECREASE(INCREASE)				
BEGINNING UNRESERVED FUND BALANCE			115,278	115,278
ENDING UNRESERVED FUND BALANCE			<hr/> <u>115,278</u>	<hr/> <u>115,278</u>
EMERGENCY RESERVE FUND			<hr/> <u>-</u>	<hr/> <u>-</u>

AIRPORT FUND  
BUDGET PROJECTIONS

	<u>2017-18</u> <u>PROJECTED</u>	<u>2018-19</u> <u>PROJECTED</u>	<u>2019-20</u> <u>PROJECTED</u>	<u>2020-21</u> <u>PROJECTED</u>	<u>2021-22</u> <u>PROJECTED</u>
REVENUE SOURCE:					
TAXES	\$ -	\$ -	\$ -	\$ -	\$ -
LICENSES AND PERMITS	-	-	-	-	-
INTERGOVERN REVENUE	167,000	167,000	167,000	167,000	167,000
SERVICE CHARGES	420,689	422,636	424,641	426,706	428,833
FINES AND FORFEITS	-	-	-	-	-
MISCELLANEOUS	309,964	319,255	328,825	338,682	348,835
OTHER FINANCING	-	-	-	-	-
TOTAL REVENUE	<u>\$897,653</u>	<u>\$908,891</u>	<u>\$920,466</u>	<u>\$932,388</u>	<u>\$944,668</u>
EXPENSE OBJECT:					
PERSONNEL SERVICES	\$ 844,352	\$ 863,861	\$ 883,992	\$ 904,773	\$ 926,234
MATERIALS & SUPPLIES	161,040	164,261	167,546	170,897	174,315
CONTRACTUAL SERVICES	337,262	343,753	350,374	357,127	364,016
GENERAL OPERATIONS	22,052	22,493	22,943	23,402	23,870
CAPITAL OUTLAY	-	-	-	-	-
SPECIAL PROJECTS	1,020	1,040	1,061	1,082	1,104
DEBT SERVICE	-	-	-	-	-
TOTAL EXPENSES	<u>\$1,365,726</u>	<u>\$1,395,408</u>	<u>\$1,425,916</u>	<u>\$1,457,281</u>	<u>\$1,489,539</u>
FUND TRANSFERS IN	468,073	486,517	505,450	524,893	544,871
FUND TRANSFERS OUT	-	-	-	-	-
PROJECTED REVENUE OVER(UNDER) BUDGET					
PROJECTED EXPENDITURES UNDER(OVER) BUDGET					
RESERVED FUND BALANCE DECREASE(INCREASE)					
EMERGENCY RESERVE FUND BALANCE DECREASE(INCREASE)					
BEGINNING UNRESERVED FUND BALANCE	115,278	115,278	115,278	115,278	115,278
ENDING UNRESERVED FUND BALANCE	<u>115,278</u>	<u>115,278</u>	<u>115,278</u>	<u>115,278</u>	<u>115,278</u>
EMERGENCY RESERVE FUND	<u>-</u>	<u>-</u>	<u>-</u>	<u>-</u>	<u>-</u>



AIRPORT FUND REVENUE

	2013-14 <u>ACTUAL</u>	2014-15 <u>ACTUAL</u>	2015-16 <u>BUDGET</u>	2016-17 <u>PROPOSED</u>
DOT-FAA Control Tower	\$ 167,000	\$ 167,000	\$ 167,000	\$ 167,000
Other Federal Grants	42,929	95,548	-	-
Other State Grants	-	18,000	-	765,000
	<u>209,929</u>	<u>280,548</u>	<u>167,000</u>	<u>932,000</u>
Special Event Fees	148,285	2,765	-	-
Miscellaneous Usage Fees	9,136	9,744	9,500	61,199
Airport Sales-Jet A Fuel Sales	1,054,503	812,635	949,050	720,300
Airport Sales-100 LL Fuel Sales	408,234	360,073	347,000	331,000
Airport Sales-Oil Sales	12,172	9,141	10,500	9,500
Airport Sales-Deicing	296	-	-	100
Airport Sales-Catering	403	536	650	200
Airport Sales-Aircraft Washing	1,121	484	550	300
Airport Sales-Misc Retail Sales	6,719	7,002	7,500	7,500
Airport Sales-Miscellaneous Fees	11,349	3,643	4,000	7,000
Airport Sales-Emerg Call Out Fees	2,100	1,250	1,500	1,200
Cost of Items Resold-Jet A Fuel Sales	(799,359)	(266,914)	(719,420)	(470,000)
Cost of Items Resold-100 LL Fuel Sale	(308,426)	47,877	(262,160)	(235,000)
Cost of Items Resold-Oil Sales	(9,968)	(3,792)	(7,875)	(7,000)
Cost of Items Resold-Misc Retail Sales	(14,240)	(1,966)	(10,500)	(7,500)
Cost of Items Resold-Misc Fees	(2,475)	-	-	-
	<u>519,851</u>	<u>982,477</u>	<u>330,295</u>	<u>418,799</u>
Interest on Overnight Inv.	549	380	450	250
Office Space Lease	14,546	13,904	14,540	15,489
Crop Lease	38,181	43,669	49,155	49,158
Building Lease	11,306	12,324	12,660	12,663
Land Lease	29,433	29,588	30,835	27,071
Aviation Rental	9,408	12,658	9,855	14,108
Restaurant Rental	12,245	9,331	9,000	9,000
Retail Space Lease	23,207	9,878	18,500	5,500
Sign Rentals	2,904	2,904	2,904	2,904
T-Hanger Rental	110,231	139,746	131,040	157,500
Cash Over and Short	(0)	(191)	-	-
Fuel Flowage Fees	6,841	6,381	6,600	6,600
General Miscellaneous	889	1,451	800	700
	<u>259,740</u>	<u>282,025</u>	<u>286,339</u>	<u>300,943</u>
Transfer from General Fund	485,329	543,950	643,244	674,596
Transfers from Fringe Benefits	623	-	-	-
	<u>485,952</u>	<u>543,950</u>	<u>643,244</u>	<u>674,596</u>
	<u>\$1,475,472</u>	<u>\$2,089,000</u>	<u>\$1,426,878</u>	<u>\$2,326,338</u>

AIRPORT OPERATIONS (2020)

BUDGET BY MAJOR OBJECT

	2013-14 <u>ACTUAL</u>	2014-15 <u>ACTUAL</u>	2015-16 <u>BUDGET</u>	2016-17 <u>PROPOSED</u>
PERSONNEL COSTS	\$517,021	\$528,367	\$538,074	\$551,944
MATERIALS AND SUPPLIES	124,968	127,330	126,144	118,058
CONTRACTUAL SERVICES	261,518	371,042	278,094	361,467
GENERAL OPERATIONS	20,426	8,089	10,670	12,920
CAPITAL EXPENDITURES	710	20,493	50,000	861,000
SPECIAL PROJECTS	192,646	48	1,000	1,000
DEBT PAYMENTS	-	120	-	-
TRANSFERS	-	-	-	-
	<u>\$1,117,289</u>	<u>\$1,055,490</u>	<u>\$1,003,982</u>	<u>\$1,906,389</u>

TOTAL PERSONNEL SERVICE BY POSITION  
AIRPORT OPERATIONS

CLASSIFICATION	SALARY GRADE (Details in Appendices)	2015-2016 FISCAL YEAR	2016-2017 FISCAL YEAR
Regular Employees			
Assistant City Manager-Devl Services	Grade W	0.10	0
Airport Manager	Grade S	1	1
Control Tower Chief	Grade R	1	1
Air Traffic Controllers	Grade Q	2	2
Operations Supervisor	Grade L	1	0
Airport Project Specialist	Grade L	1	1
Maintenance Crew Leader	Grade H	0	1
Maintenance Worker II	Grade G	2	1
Maintenance Worker I	Grade E	0	1
TOTAL		8.10	8.00

Part-Time Employees

	2015-2016		2016-2017	
	<u>Actual Hours</u>	<u>Full-Time Equivalent</u>	<u>Actual Hours</u>	<u>Full-Time Equivalent</u>
Maintenance Worker	360	0.17	716	0.34
Administrative Clerk	800	0.38	1,400	0.67
	<u>1,160</u>	<u>0.56</u>	<u>2,116</u>	<u>1.02</u>

AIRPORT FBO OPERATIONS (2022)

BUDGET BY MAJOR OBJECT

	2013-14 <u>ACTUAL</u>	2014-15 <u>ACTUAL</u>	2015-16 <u>BUDGET</u>	2016-17 <u>PROPOSED</u>
PERSONNEL COSTS	\$ 270,941	\$ 276,400	\$ 271,652	\$ 273,488
MATERIALS AND SUPPLIES	43,002	44,875	46,901	43,524
CONTRACTUAL SERVICES	59,077	81,146	96,493	94,237
GENERAL OPERATIONS	8,066	7,976	7,850	8,700
CAPITAL EXPENDITURES	-	-	-	-
SPECIAL PROJECTS	-	-	-	-
DEBT PAYMENTS	-	-	-	-
TRANSFERS	-	-	-	-
	<u>\$ 381,085</u>	<u>\$ 410,396</u>	<u>\$ 422,896</u>	<u>\$ 419,949</u>

TOTAL PERSONNEL SERVICE BY POSITION  
AIRPORT FBO OPERATIONS

CLASSIFICATION	SALARY GRADE (Details in Appendices)		2015-2016 FISCAL YEAR	2016-2017 FISCAL YEAR
Regular Employees				
Flight Line Supervisor	Grade	M	1	1
Administrative Clerk	Grade	D	1	1
Flight Line Technician	Grade	C	<u>3</u>	<u>3</u>
TOTAL			5	5

Part-Time Employees

	2015-2016		2016-2017	
	<u>Actual Hours</u>	<u>Full-Time Equivalent</u>	<u>Actual Hours</u>	<u>Full-Time Equivalent</u>
Administrative Clerk	1,248	0.60	1,664	0.80
Lineman	<u>2,080</u>	<u>1.00</u>	<u>2,480</u>	<u>1.19</u>
	3,328	1.60	4,144	1.99

---

# **PARKS AND RECREATION FUND**

---

**PARKS AND RECREATION FUND  
BUDGET HIGHLIGHTS**

**ACTIVITIES**

The Parks and Recreation Fund is established to separate the revenue sources and expenditures used to operate the parks and recreation activities. The following activities are included in this fund:

**Arena Maintenance** - This division is responsible for the operations and maintenance of the A.C. Brase building in Arena Park.

**Osage Park Community Center** – This division is responsible for the operations and maintenance of the multi-purpose building at Osage Park.

**Shawnee Park Community Center** – This division is responsible for the operations and maintenance of the multi-purpose building at Shawnee Park

**Central Pool** - This division operates an indoor/outdoor facility in conjunction with the Public School District.

**Family Aquatic Center** - This division is responsible for the operations and maintenance of an outdoor family aquatic center adjacent to the Osage Park Community Center.

**Recreation** - This division operates a year-round public program for all age groups, including a multitude of programs, and coordinates use of all facilities by organized groups.

**Municipal Band** - The Municipal Band provides open-air concerts at the band shell in Capaha Park and additional concerts in other areas within the community.

**SIGNIFICANT OPERATING CHANGES**

**Osage Park Community Center** – This budget adds 1,500 hours for part-time personal trainers at a cost of \$33,084. Personal training fee revenue will exceed this additional cost.

**Shawnee Park Community Center** – This budget reduces total part-time hours by 579 hours. This reduction should produce a savings of \$5,779.

**Family Aquatic Center** – This budget adds 640 hours for slide attendants and 640 hours for lifeguards to cover the first full year of operation of a new water feature which became operational during July 2015. Total costs of these additions are \$11,377 and will be funded by a transfer from the parks / stormwater sales tax – operations fund.

**Recreation** – This budget eliminates 480 hours for an intern position resulting in a savings of \$4,939 and the reduction of an additional 373 part-time hours resulting in additional savings of \$3,387.

---

### SIGNIFICANT ONE-TIME EXPENDITURES

This budget includes \$10,000 for an automatic floor scrubber for the A. C. Brase building, \$12,500 to replace the flooring in meeting room 2AB and \$2,500 to install a mounted projector in meeting room 3AB at the Osage Community Center, \$4,500 for a shade structure at Central Pool, and \$8,000 to replace 4 funbrellas at Cape Splash. All of these purchases will be funded by a transfer from the parks / stormwater sales tax – operations fund.

This budget also includes \$5,000 for artist fees related to a public art exhibit and \$23,000 for the cost of July 4<sup>th</sup> fireworks. The Isle of Capri will contribute \$7,500 toward the cost of the fireworks.

### REVENUE/RATE INCREASES

Rate increases are proposed for a couple leagues in this budget. The Men's Basketball League is proposed to increase to \$350 from \$330 per team. The NFL Youth Flag Football League is proposed to increase to \$60 from \$55 per participant. As new activities arise during the year, user fees may be charged to offset operating costs.

### REVENUE/EXPENDITURE PROJECTIONS

Service charge revenue is projected to grow 3% annually over fiscal year ending June 30, 2017 levels. Operating expenses, excluding personnel expenses, are projected to grow at a 2% annual inflation rate. Personnel expenditures are projected to include wage increases equal to the inflation rate in the fiscal years after June 30, 2017 and an annual turnover rate of 5%. Costs for health and dental insurance are projected to grow 6% and 3% annually, respectively, during these years.

No capital outlays are projected since any capital outlays would be supported by General Fund transfers.

---

THIS PAGE INTENTIONALLY LEFT BLANK

---

## PARKS & RECREATION FUND 2016-2017 RESOURCES

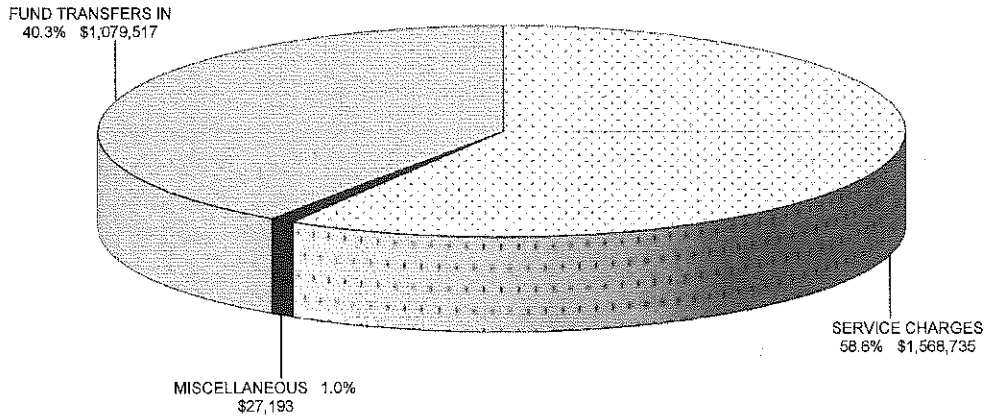

## PARKS & RECREATION FUND 2016-2017 EXPENDITURES

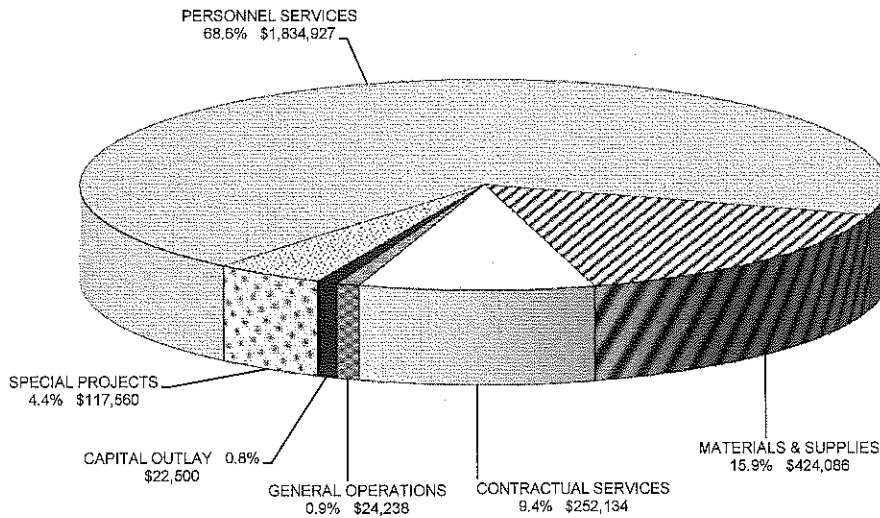



PARKS & RECREATION FUND  
BUDGET BY MAJOR OBJECT

	<u>2013-14</u> <u>ACTUAL</u>	<u>2014-15</u> <u>ACTUAL</u>	<u>2015-16</u> <u>BUDGET</u>	<u>2016-17</u> <u>BUDGET</u>
REVENUE SOURCE:				
TAXES	\$ -	\$ -	\$ -	\$ -
LICENSES AND PERMITS	-	-	-	-
INTERGOVERN REVENUE	-	-	-	-
SERVICE CHARGES	1,179,484	1,317,695	1,347,465	1,568,735
FINES AND FORFEITS	-	-	-	-
MISCELLANEOUS	18,252	26,375	24,880	27,193
OTHER FINANCING	-	228	-	-
	\$ 1,197,736	\$ 1,344,298	\$ 1,372,345	\$ 1,595,928
EXPENSE OBJECT:				
PERSONNEL SERVICES	\$1,604,046	\$1,687,673	\$1,758,755	\$1,834,927
MATERIALS & SUPPLIES	456,790	462,180	491,769	424,086
CONTRACTUAL SERVICES	177,303	236,545	202,447	252,134
GENERAL OPERATIONS	25,673	12,342	31,675	24,238
CAPITAL OUTLAY	-	3,578	-	22,500
SPECIAL PROJECTS	91,390	113,409	93,415	117,560
DEBT SERVICE	-	-	-	-
	\$2,355,203	\$2,515,728	\$2,578,061	\$2,675,445
FUND TRANSFERS IN	1,207,379	1,209,798	1,205,716	1,079,517
FUND TRANSFERS OUT	-	3,422	-	-
PROJECTED REVENUE OVER(UNDER) BUDGET			25,632	
PROJECTED EXPENDITURES UNDER(OVER) BUDGET			(25,632)	
RESERVED FUND BALANCE DECREASE(INCREASE)				
EMERGENCY RESERVE FUND BALANCE DECREASE(INCREASE)				
BEGINNING UNRESERVED FUND BALANCE			26,813	26,813
ENDING UNRESERVED FUND BALANCE			26,813	26,813
EMERGENCY RESERVE FUND			-	-
OPERATIONS AND REPAIR FUND		371,889	371,889	371,889

PARKS & RECREATION FUND  
BUDGET PROJECTIONS

	2017-18 <u>PROJECTED</u>	2018-19 <u>PROJECTED</u>	2019-20 <u>PROJECTED</u>	2020-21 <u>PROJECTED</u>	2021-22 <u>PROJECTED</u>
REVENUE SOURCE:					
TAXES	\$ -	\$ -	\$ -	\$ -	\$ -
LICENSES AND PERMITS	-	-	-	-	-
INTERGOVERN REVENUE	-	-	-	-	-
SERVICE CHARGES	1,615,797	1,664,271	1,714,199	1,765,625	1,818,594
FINES AND FORFEITS	-	-	-	-	-
MISCELLANEOUS	27,193	27,193	27,193	27,193	27,193
OTHER FINANCING	-	-	-	-	-
<b>TOTAL REVENUE</b>	<b>\$1,642,990</b>	<b>\$1,691,464</b>	<b>\$1,741,392</b>	<b>\$1,792,818</b>	<b>\$1,845,787</b>
EXPENSE OBJECT:					
PERSONNEL SERVICES	\$ 1,879,281	\$ 1,919,901	\$ 1,961,623	\$ 2,004,487	\$2,048,536
MATERIALS & SUPPLIES	417,268	425,613	434,125	442,808	451,664
CONTRACTUAL SERVICES	257,177	262,321	267,567	272,918	278,376
GENERAL OPERATIONS	24,723	25,217	25,721	26,235	26,760
CAPITAL OUTLAY	-	-	-	-	-
SPECIAL PROJECTS	119,911	122,309	124,755	127,250	129,795
DEBT SERVICE	-	-	-	-	-
<b>TOTAL EXPENSES</b>	<b>\$2,698,360</b>	<b>\$2,755,361</b>	<b>\$2,813,791</b>	<b>\$2,873,698</b>	<b>\$2,935,131</b>
FUND TRANSFERS IN	1,055,370	1,063,897	1,072,399	1,080,880	1,089,344
FUND TRANSFERS OUT	-	-	-	-	-
PROJECTED REVENUE OVER(UNDER) BUDGET					
PROJECTED EXPENDITURES UNDER(OVER) BUDGET					
RESERVED FUND BALANCE DECREASE(INCREASE)					
EMERGENCY RESERVE FUND BALANCE DECREASE(INCREASE)					
BEGINNING UNRESERVED FUND BALANCE	26,813	26,813	26,813	26,813	26,813
ENDING UNRESERVED FUND BALANCE	<u>26,813</u>	<u>26,813</u>	<u>26,813</u>	<u>26,813</u>	<u>26,813</u>
EMERGENCY RESERVE FUND	<u>-</u>	<u>-</u>	<u>-</u>	<u>-</u>	<u>-</u>
OPERATIONS AND REPAIR FUND	371,889	371,889	371,889	371,889	371,889

PARKS & RECREATION FUND REVENUE

	2013-14 <u>ACTUAL</u>	2014-15 <u>ACTUAL</u>	2015-16 <u>BUDGET</u>	2016-17 <u>PROPOSED</u>
Arena Building Usage Fees	59,538	54,195	59,500	50,000
Park Shelter Fees	14,575	11,645	14,000	12,000
Miscellaneous Usage Fees	1,692	6,261	1,800	10,000
City Central Pool Fees	108,060	101,267	100,000	105,000
Aquatic Center Annual Passes	33,755	32,701	38,000	35,000
Special Event Fees	-	876	-	900
Special Event Fees	345	410	1,200	1,200
Recreation Special Event Fees	93,773	108,570	109,905	114,430
Central Pool Concessions	1,612	1,838	2,100	2,000
Parks Miscellaneous Retail Sales	64	-	-	50
Central Vending Machines	1,801	3,684	2,400	2,400
Cost of Items Resold	(4,589)	(653)	(5,000)	(4,500)
Aquatic Center-Concessions	148,910	158,265	175,000	185,000
Aquatic Miscellaneous Retail Sales	(2,084)	1,622	2,000	2,500
Cost of Items Resold	(82,557)	(86,011)	(100,000)	(95,000)
League Fees	105,750	106,679	112,505	104,380
Special Events Concessions	992	1,366	650	1,350
Recreation Vending Machines	2,112	2,734	2,300	2,500
Cost of Items Resold	(2,838)	(2,138)	(2,800)	(2,800)
Osage Repair & Replacement	6,323	7,051	6,500	9,500
Osage Building Usage	89,439	109,488	216,800	240,000
Cost of Items Resold	(17,825)	(10,450)	(16,000)	(18,000)
Shawnee Park Ctr Bldg Usage Fees	19,529	18,406	38,800	38,800
Shawnee Park Program Fees	19,900	19,928	3,200	5,700
Shawnee Pk Ctr-Concs-Non-Alcoholic	1,529	1,742	1,500	1,700
Shawnee Pk Ctr Vending Machines	4,594	3,788	4,400	4,400
Cost of Items Resold	(4,095)	(1,482)	(4,000)	(4,000)
Recreation Program Fees	25,598	34,172	28,375	29,325
Aquatics Program Fees-Central	22,958	17,131	23,000	20,000
Aquatics Program Fees-Splash	23,280	27,972	24,000	27,000
Family Aquatic Ctr Pool Usage	348,537	406,451	457,000	605,000
Miscellaneous Fees	7,712	7,877	8,000	8,000
Recreation Tournament Fees	1,920	1,860	1,980	1,900
Miscellaneous Sales	380	(8)	150	-
Osage Building Concessions	11,210	16,656	12,000	12,000
Osage Vending	11,654	13,621	12,000	11,000
Osage Program Fees	125,929	140,124	16,200	50,000
Shawnee Pk Ctr Prog Fees	-	60	-	-
	<u>1,179,484</u>	<u>1,317,695</u>	<u>1,347,465</u>	<u>1,568,735</u>
Interest on Overnight Investment	4,321	5,496	5,000	5,625
Operating Contributions	-	7,550	7,500	7,500
Property Rental	11,830	11,880	11,880	13,068
General Miscellaneous	1,358	905	500	1,000
Cash Overages & Shortages	<u>744</u>	<u>545</u>	<u>-</u>	<u>-</u>
	18,252	26,375	24,880	27,193
Proceeds from Sale of Assets	<u>-</u>	<u>228</u>	<u>-</u>	<u>-</u>
	-	228	-	-
Transfer-General Fund	847,000	747,496	828,184	688,053
Transfer-Park/Stormwtr-Operatin	360,379	457,530	377,532	391,464
Transfer-Fleet Maint Fund	<u>-</u>	<u>4,772</u>	<u>-</u>	<u>-</u>
	1,207,379	1,209,798	1,205,716	1,079,517
	<u>\$ 2,405,115</u>	<u>\$ 2,554,096</u>	<u>\$ 2,578,061</u>	<u>\$ 2,675,445</u>

ARENA MAINTENANCE (5032)

BUDGET BY MAJOR OBJECT

	2013-14 <u>ACTUAL</u>	2014-15 <u>ACTUAL</u>	2015-16 <u>BUDGET</u>	2016-17 <u>PROPOSED</u>
PERSONNEL COSTS	\$150,317	\$153,466	\$161,114	\$162,502
MATERIALS AND SUPPLIES	73,250	93,334	80,625	70,583
CONTRACTUAL SERVICES	19,177	22,029	21,474	22,486
GENERAL OPERATIONS	883	1,185	955	1,150
CAPITAL EXPENDITURES	-	-	-	10,000
SPECIAL PROJECTS	-	-	-	-
DEBT PAYMENTS	-	-	-	-
TRANSFERS	-	-	-	-
	<u>\$243,627</u>	<u>\$270,013</u>	<u>\$264,168</u>	<u>\$266,721</u>

TOTAL PERSONNEL SERVICE BY POSITION  
ARENA MAINTENANCE

CLASSIFICATION	SALARY GRADE (Details in Appendices)		2015-2016 FISCAL YEAR	2016-2017 FISCAL YEAR
Regular Employees				
Maintenance Worker II	Grade	G	<u>3</u>	<u>3</u>
TOTAL			3	3
Part-Time Employees				
	Actual <u>Hours</u>	2015-2016 Full-Time <u>Equivalent</u>	Actual <u>Hours</u>	2016-2017 Full-Time <u>Equivalent</u>
Park Keepers	1925	0.93	1869	0.90

OSAGE PARK COMMUNITY CENTER (5034)

BUDGET BY MAJOR OBJECT

	2013-14 <u>ACTUAL</u>	2014-15 <u>ACTUAL</u>	2015-16 <u>BUDGET</u>	2016-17 <u>PROPOSED</u>
PERSONNEL COSTS	\$315,944	\$365,519	\$362,431	\$400,272
MATERIALS AND SUPPLIES	125,373	123,623	131,873	109,539
CONTRACTUAL SERVICES	37,067	43,312	42,107	45,513
GENERAL OPERATIONS	1,918	1,482	1,820	2,035
CAPITAL EXPENDITURES	-	3,578	-	12,500
SPECIAL PROJECTS	-	-	-	-
DEBT PAYMENTS	-	-	-	-
TRANSFERS	-	3,422	-	-
	<u>\$480,302</u>	<u>\$540,936</u>	<u>\$538,231</u>	<u>\$569,859</u>

TOTAL PERSONNEL SERVICE BY POSITION  
OSAGE PARK COMMUNITY CENTER

CLASSIFICATION	SALARY GRADE (Details in Appendices)		2015-2016 FISCAL YEAR	2016-2017 FISCAL YEAR
Regular Employees				
Recreation Supervisor	Grade	O	1	1
Facility Maintenance Coordinator	Grade	M	0.50	0.50
Maintenance Worker II	Grade	G	2	2
Administrative Assistant	Grade	F	1	1
TOTAL			4.50	4.50

Part-Time Employees

	2015-2016		2016-2017	
	<u>Actual Hours</u>	<u>Full-Time Equivalent</u>	<u>Actual Hours</u>	<u>Full-Time Equivalent</u>
Morning Manager	2,250	1.08	2,492	1.20
Evening Manager	1,290	0.62	1,300	0.63
Personal Trainer	0	0.00	1,500	0.72
Office Worker	425	0.20	425	0.20
Administrative Clerk	988	0.48	988	0.48
Maintenance Workers	1,708	0.82	1,843	0.89
Concessions Worker	450	0.22	487	0.23
Facility Attendants	7,800	3.75	7,558	3.63
	14,911	7.17	16,593	7.98

SHAWNEE PARK COMMUNITY CENTER (5036)

BUDGET BY MAJOR OBJECT

	2013-14 <u>ACTUAL</u>	2014-15 <u>ACTUAL</u>	2015-16 <u>BUDGET</u>	2016-17 <u>PROPOSED</u>
PERSONNEL COSTS	\$ 138,395	\$ 113,883	\$ 125,328	\$120,953
MATERIALS AND SUPPLIES	39,125	39,281	37,450	35,972
CONTRACTUAL SERVICES	20,157	20,127	21,549	21,722
GENERAL OPERATIONS	1,830	219	2,306	1,838
CAPITAL EXPENDITURES	-	-	-	-
SPECIAL PROJECTS	329	192	1,000	1,000
DEBT PAYMENTS	-	-	-	-
TRANSFERS	-	-	-	-
	<u>\$ 199,836</u>	<u>\$ 173,701</u>	<u>\$ 187,633</u>	<u>\$181,485</u>

TOTAL PERSONNEL SERVICE BY POSITION  
SHAWNEE PARK COMMUNITY CENTER

CLASSIFICATION	SALARY GRADE (Details in Appendices)		2015-2016 FISCAL YEAR	2016-2017 FISCAL YEAR
Regular Employees				
Recreation Specialist	Grade	M	<u>0.50</u>	<u>0.50</u>
TOTAL			0.50	0.50

Part-Time Employees

	2015-2016		2016-2017	
	<u>Actual Hours</u>	<u>Full-Time Equivalent</u>	<u>Actual Hours</u>	<u>Full-Time Equivalent</u>
Managers	3,165	1.52	4,000	1.92
Gym Supervisor	1,085	0.52	890	0.43
Fitness Room Supervisor	2,759	1.33	2,253	1.08
Program/Party planners	200	0.10	200	0.10
Concessions Workers	105	0.05	105	0.05
Maintenance Workers	150	0.07	50	0.02
Assistant Maintenance Worker	624	0.30	872	0.42
Administrative Clerk	1,310	0.63	624	0.30
Training/Meetings Staff	60	0.03	60	0.03
Event Supervisor	175	0.08	0	0.00
	<u>9,633</u>	<u>4.63</u>	<u>9,054</u>	<u>4.35</u>

CENTRAL POOL (5040)

BUDGET BY MAJOR OBJECT

	2013-14 <u>ACTUAL</u>	2014-15 <u>ACTUAL</u>	2015-16 <u>BUDGET</u>	2016-17 <u>PROPOSED</u>
PERSONNEL COSTS	\$232,788	\$216,670	\$238,285	\$240,778
MATERIALS AND SUPPLIES	136,122	106,248	137,271	108,955
CONTRACTUAL SERVICES	23,552	19,412	23,146	26,413
GENERAL OPERATIONS	601	1,107	1,450	1,850
CAPITAL EXPENDITURES	-	-	-	-
SPECIAL PROJECTS	3,418	1,679	1,500	1,500
DEBT PAYMENTS	-	-	-	-
TRANSFERS	-	-	-	-
	<u>\$396,481</u>	<u>\$345,116</u>	<u>\$401,652</u>	<u>\$379,496</u>

TOTAL PERSONNEL SERVICE BY POSITION  
CENTRAL POOL

CLASSIFICATION	SALARY GRADE (Details in Appendices)	2015-2016 FISCAL YEAR	2016-2017 FISCAL YEAR
Regular Employees			
Recreation Coordinator	Grade L	1	1
Senior Maintenance Worker	Grade I	<u>1</u>	<u>1</u>
TOTAL		2	2

Part-Time Employees

	2015-2016		2016-2017	
	<u>Actual Hours</u>	<u>Full-Time Equivalent</u>	<u>Actual Hours</u>	<u>Full-Time Equivalent</u>
Managers	2,610	1.25	2,610	1.25
Instructor	1,784	0.86	1,784	0.86
Lifeguards, Cashiers, Other	10,515	5.06	10,515	5.06
Maintenance	<u>200</u>	<u>0.10</u>	<u>200</u>	<u>0.10</u>
	15,109	7.26	15,109	7.26

FAMILY AQUATIC CENTER (5042)

BUDGET BY MAJOR OBJECT

	2013-14 ACTUAL	2014-15 ACTUAL	2015-16 BUDGET	2016-17 PROPOSED
PERSONNEL COSTS	\$ 295,124	353,752	383,220	\$ 399,038
MATERIALS AND SUPPLIES	69,596	89,000	93,100	88,987
CONTRACTUAL SERVICES	33,854	74,263	25,490	58,387
GENERAL OPERATIONS	5,579	3,367	6,750	2,750
CAPITAL EXPENDITURES	-	-	-	-
SPECIAL PROJECTS	570	98	1,000	1,000
DEBT PAYMENTS	-	-	-	-
TRANSFERS	-	-	-	-
	<u>\$ 404,723</u>	<u>\$ 520,479</u>	<u>\$509,560</u>	<u>\$550,162</u>

TOTAL PERSONNEL SERVICE BY POSITION  
FAMILY AQUATIC CENTER

CLASSIFICATION	SALARY GRADE (Details in Appendices)		2015-2016 FISCAL YEAR	2016-2017 FISCAL YEAR
Regular Employees				
Recreation Supervisor	Grade	O	1	1
Facility Maintenance Coordinator	Grade	M	<u>0.50</u>	<u>0.50</u>
TOTAL			1.50	1.50

Part-Time Employees

	2015-2016		2016-2017	
	Actual Hours	Full-Time Equivalent	Actual Hours	Full-Time Equivalent
Lifeguard Managers	1,100	0.53	1,100	0.53
Concessions Managers	1,206	0.58	1,206	0.58
Concessions Workers	4,750	2.28	4,750	2.28
Admissions Worker	1,200	0.58	1,200	0.58
Customer Service	810	0.39	810	0.39
Instructors	1,006	0.48	1,006	0.48
Head Lifeguards	1,752	0.84	1,752	0.84
Lifeguards	14,956	7.19	15,596	7.50
Slide Attendants	4,136	1.99	4,776	2.30
Maintenance	1,070	0.51	1,070	0.51
Other/training	<u>540</u>	<u>0.26</u>	<u>540</u>	<u>0.26</u>
	32,526	15.64	33,806	16.25



RECREATION (5050)

BUDGET BY MAJOR OBJECT

	2013-14 <u>ACTUAL</u>	2014-15 <u>ACTUAL</u>	2015-16 <u>BUDGET</u>	2016-17 <u>PROPOSED</u>
PERSONNEL COSTS	\$471,478	\$484,384	\$488,377	\$511,384
MATERIALS AND SUPPLIES	13,324	9,790	10,650	8,050
CONTRACTUAL SERVICES	21,940	31,008	22,110	51,048
GENERAL OPERATIONS	14,862	4,982	18,394	14,615
CAPITAL EXPENDITURES	-	-	-	-
SPECIAL PROJECTS	87,073	111,441	89,915	91,060
DEBT PAYMENTS	-	-	-	-
TRANSFERS	-	-	-	-
	<u>\$608,677</u>	<u>\$641,606</u>	<u>\$629,446</u>	<u>\$676,157</u>

TOTAL PERSONNEL SERVICE BY POSITION  
RECREATION

CLASSIFICATION	SALARY GRADE (Details in Appendices)	2015-2016 FISCAL YEAR	2016-2017 FISCAL YEAR
Regular Employees			
Recreation Division Manager	Grade S	2	2
Recreation Specialist	Grade M	1	1
Recreation Coordinator I	Grade L	2	2.5
Fitness/Wellness Coordinator	Grade L	0.50	0.50
Administrative Secretary	Grade E	1	1
TOTAL		6.50	7.00

Part-Time Employees

	2015-2016		2016-2017	
	<u>Actual Hours</u>	<u>Full-Time Equivalent</u>	<u>Actual Hours</u>	<u>Full-Time Equivalent</u>
Activity Coordinators	3342	1.61	3081	1.48
Sports Officials	4584	2.20	2894	1.39
Instructors	918	0.44	1123	0.54
Assistant Recreation Programers	496	0.24	496	0.24
Interns	480	0.23	0	0.00
Concessions Managers	0	0.00	12	0.01
Concessions Workers	152	0.07	140	0.07
Maintenance	20	0.01	20	0.01
Gym Supervisor	10	0.00	10	0.00
Scorekeepers	0	0.00	1373	0.66
Office Worker	40	0.02	40	0.02
	<u>10,042</u>	<u>4.83</u>	<u>9,189</u>	<u>4.42</u>

MUNICIPAL BAND (5060)

BUDGET BY MAJOR OBJECT

	2013-14 <u>ACTUAL</u>	2014-15 <u>ACTUAL</u>	2015-16 <u>BUDGET</u>	2016-17 <u>PROPOSED</u>
PERSONNEL COSTS	\$ -	\$ -	\$ -	\$ -
MATERIALS AND SUPPLIES	-	905	800	2,000
CONTRACTUAL SERVICES	21,556	26,393	46,571	26,565
GENERAL OPERATIONS	-	-	-	-
CAPITAL EXPENDITURES	-	-	-	-
SPECIAL PROJECTS	-	-	-	23,000
DEBT PAYMENTS	-	-	-	-
TRANSFERS	-	-	-	-
	<u>\$21,556</u>	<u>\$27,299</u>	<u>\$47,371</u>	<u>\$51,565</u>

---

THIS PAGE INTENTIONALLY LEFT BLANK

---

---

**HEALTH**

**FUND**

---

**HEALTH FUND**  
**BUDGET HIGHLIGHTS**

**ACTIVITIES**

The Health Fund provides limited funding for enforcement of health ordinances. Three animal control officers are funded through a special property tax in this fund. Weed abatement activities and demolitions of condemned structures are also funded here, along with contractual payments to the County Health Department and Humane Society.

**SIGNIFICANT OPERATING CHANGES**

This budget provides a \$132,207 allocation that may be spent on demolishing dangerous buildings. During the previous budget this allocation was \$115,034 but it is currently estimated that only about \$45,000 of this allocation will be spent. This budget provides increasing the annual payment to the Humane Society by \$1,800 (3.1%).

**SIGNIFICANT ONE-TIME EXPENDITURES**

This budget includes an additional \$100,000 that may be spent on demolishing dangerous buildings.

**REVENUE/RATE INCREASES**

No tax levy increase is proposed in this budget.

**REVENUE/EXPENDITURE PROJECTIONS**

Real Estate and Property Tax assessed valuations are projected to grow at 1.5% and 3.0% respectively for the fiscal year ending June 30, 2016 and 2.0% annually for the following five years. No tax levy increases are assumed in any of the years. All other fees and licenses are maintained at current levels.

Operating expenses, excluding personnel expenses, allocations to demolish dangerous buildings, and annual payment to Cape County Health Department are also projected to grow at a 2% rate of inflation. Personnel expenditures are projected to include wage increases equal to the inflation rate in the fiscal years after June 30, 2017 and an annual turnover rate of 5%. Costs for health and dental insurance are projected to grow 6% and 3% annually, respectively, during these years. Allocations to demolish dangerous buildings and payments to Cape County Health Department are projected to be \$32,207 and \$21,150 respectively during these years.

No provisions are made for capital expenditures during these years.

## HEALTH FUND 2016-2017 RESOURCES

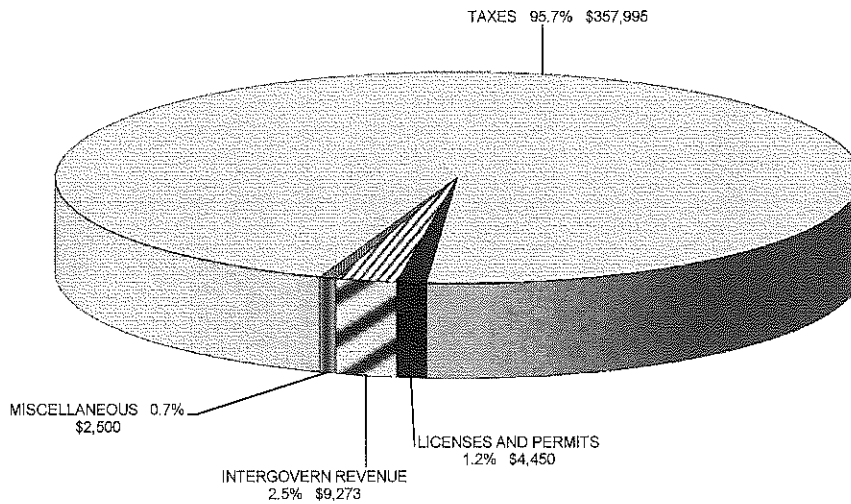

## HEALTH FUND 2016-2017 EXPENDITURES

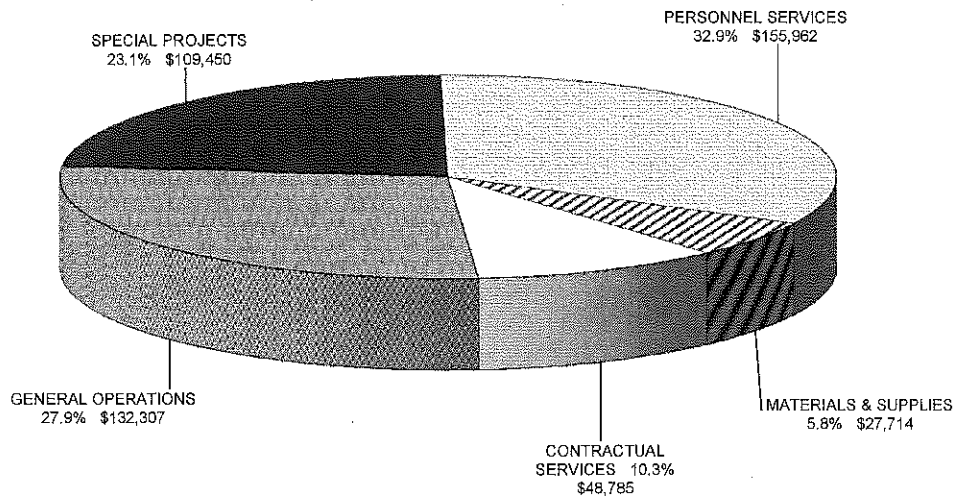

HEALTH FUND  
BUDGET BY MAJOR OBJECT

	2013-14 <u>ACTUAL</u>	2014-15 <u>ACTUAL</u>	2015-16 <u>BUDGET</u>	2016-17 <u>BUDGET</u>
REVENUE SOURCE:				
TAXES	\$337,227	\$342,500	\$350,059	\$357,995
LICENSES AND PERMITS	4,491	2,512	4,478	4,450
INTERGOVERN REVENUE	9,209	9,273	9,210	9,273
SERVICE CHARGES	-	-	-	-
FINES AND FORFEITS	-	-	-	-
MISCELLANEOUS	5,712	5,412	3,750	2,500
OTHER FINANCING	-	-	-	-
	<u>          </u>	<u>          </u>	<u>          </u>	<u>          </u>
TOTAL REVENUE	\$356,639	\$359,697	\$367,497	\$374,218
EXPENSE OBJECT:				
PERSONNEL SERVICES	\$173,924	\$148,464	\$164,530	\$155,962
MATERIALS & SUPPLIES	18,300	22,117	32,775	27,714
CONTRACTUAL SERVICES	54,048	38,994	47,408	48,785
GENERAL OPERATIONS	33,762	87,650	115,134	132,307
CAPITAL OUTLAY	-	75,997	-	-
SPECIAL PROJECTS	85,183	108,863	107,650	109,450
DEBT SERVICE	-	-	-	-
	<u>          </u>	<u>          </u>	<u>          </u>	<u>          </u>
TOTAL EXPENSES	\$365,218	\$482,085	\$467,497	\$474,218
FUND TRANSFERS IN	-	-	-	-
FUND TRANSFERS OUT	-	-	-	-
PROJECTED REVENUE				
OVER(UNDER) BUDGET			(1,828)	
PROJECTED EXPENDITURES				
UNDER(OVER) BUDGET			94,941	
RESERVED FUND BALANCE				
DECREASE(INCREASE)				(1,008)
EMERGENCY RESERVE FUND BALANCE				
DECREASE(INCREASE)				(1,008)
BEGINNING UNRESERVED FUND				
BALANCE			259,768	252,881
ENDING UNRESERVED FUND				
BALANCE			<u>252,881</u>	<u>151,873</u>
EMERGENCY RESERVE FUND				
			<u>70,125</u>	<u>71,133</u>

HEALTH FUND  
BUDGET PROJECTIONS

	<u>2017-18</u> <u>PROJECTED</u>	<u>2018-19</u> <u>PROJECTED</u>	<u>2019-20</u> <u>PROJECTED</u>	<u>2020-21</u> <u>PROJECTED</u>	<u>2021-22</u> <u>PROJECTED</u>
REVENUE SOURCE:					
TAXES	\$365,155	\$372,458	\$379,907	\$387,505	\$395,255
LICENSES AND PERMITS	4,450	4,450	4,450	4,450	4,450
INTERGOVERN REVENUE	9,273	9,273	9,273	9,273	9,273
SERVICE CHARGES	-	-	-	-	-
FINES AND FORFEITS	-	-	-	-	-
MISCELLANEOUS	2,730	2,706	2,687	2,673	2,663
OTHER FINANCING	-	-	-	-	-
<b>TOTAL REVENUE</b>	<b>\$381,608</b>	<b>\$388,887</b>	<b>\$396,317</b>	<b>\$403,901</b>	<b>\$411,641</b>
EXPENSE OBJECT:					
PERSONNEL SERVICES	\$ 159,606	\$ 163,367	\$ 167,252	\$ 171,264	\$ 175,411
MATERIALS & SUPPLIES	28,268	28,833	29,410	29,998	30,598
CONTRACTUAL SERVICES	49,513	50,255	51,012	51,785	52,572
GENERAL OPERATIONS	35,102	35,104	35,106	35,108	35,110
CAPITAL OUTLAY	-	-	-	-	-
SPECIAL PROJECTS	111,216	113,017	114,854	116,728	118,640
DEBT SERVICE	-	-	-	-	-
<b>TOTAL EXPENSES</b>	<b>\$383,705</b>	<b>\$390,576</b>	<b>\$397,634</b>	<b>\$404,883</b>	<b>\$412,331</b>
FUND TRANSFERS IN	-	-	-	-	-
FUND TRANSFERS OUT	-	-	-	-	-
PROJECTED REVENUE OVER(UNDER) BUDGET					
PROJECTED EXPENDITURES UNDER(OVER) BUDGET					
RESERVED FUND BALANCE DECREASE(INCREASE)					
EMERGENCY RESERVE FUND BALANCE DECREASE(INCREASE)	13,577	(1,030)	(1,059)	(1,087)	(1,118)
BEGINNING UNRESERVED FUND BALANCE	151,873	163,353	160,634	158,258	156,189
ENDING UNRESERVED FUND BALANCE	<u>163,353</u>	<u>160,634</u>	<u>158,258</u>	<u>156,189</u>	<u>154,381</u>
EMERGENCY RESERVE FUND	<u>57,556</u>	<u>58,586</u>	<u>59,645</u>	<u>60,732</u>	<u>61,850</u>



HEALTH FUND REVENUE

	2013-14 <u>ACTUAL</u>	2014-15 <u>ACTUAL</u>	2015-16 <u>BUDGET</u>	2016-17 <u>PROPOSED</u>
Real Estate Tax	\$ 256,107	\$ 259,805	\$ 266,016	\$ 267,300
Personal Property Tax	60,433	62,422	63,565	68,500
Railroad & Utility Tax	10,878	11,266	11,434	11,965
Intangible Tax	2,065	909	909	1,400
Delinquent Real Estate Tax	3,508	3,934	3,775	4,300
Delinquent Personal Prop Tax	2,313	2,292	2,300	2,400
Penalty on Delinquent R.E. Tax	1,165	1,071	1,275	1,290
Penalty on Delinquent P.P. Tax	757	801	785	840
	<u>337,227</u>	<u>342,500</u>	<u>350,059</u>	<u>357,995</u>
Animal Licenses	<u>4,491</u>	<u>2,512</u>	<u>4,478</u>	<u>4,450</u>
	4,491	2,512	4,478	4,450
County Business Surtax	<u>9,209</u>	<u>9,273</u>	<u>9,210</u>	<u>9,273</u>
	9,209	9,273	9,210	9,273
Interest on Overnight Investment	5,711	5,411	3,750	2,500
Interest on Taxes from County	<u>1</u>	<u>1</u>	<u>-</u>	<u>-</u>
	5,712	5,412	3,750	2,500
	<u>\$356,639</u>	<u>\$359,697</u>	<u>\$367,497</u>	<u>\$374,218</u>

HEALTH

BUDGET BY MAJOR OBJECT

	2013-14 <u>ACTUAL</u>	2014-15 <u>ACTUAL</u>	2015-16 <u>BUDGET</u>	2016-17 <u>PROPOSED</u>
PERSONNEL COSTS	\$173,924	\$148,464	\$164,530	\$155,962
MATERIALS AND SUPPLIES	18,300	22,117	32,775	27,714
CONTRACTUAL SERVICES	54,048	38,994	47,408	48,785
GENERAL OPERATIONS	33,762	87,650	115,134	132,307
CAPITAL EXPENDITURES	-	75,997	-	-
SPECIAL PROJECTS	85,183	108,863	107,650	109,450
DEBT PAYMENTS	-	-	-	-
TRANSFERS	-	-	-	-
	<u>\$365,218</u>	<u>\$482,085</u>	<u>\$467,497</u>	<u>\$474,218</u>

TOTAL PERSONNEL SERVICE BY POSITION  
HEALTH

CLASSIFICATION	SALARY GRADE (Details in Appendices)		2015-2016 FISCAL YEAR	2016-2017 FISCAL YEAR
Regular Employees				
Nuisance Abatement Supervisor	Grade	CC	1	1
Nuisance Abatement Officer	Grade	E	<u>2</u>	<u>2</u>
TOTAL			3	3
Part-Time Employees				
	2015-2016		2016-2017	
	<u>Actual Hours</u>	<u>Full-Time Equivalent</u>	<u>Actual Hours</u>	<u>Full-Time Equivalent</u>
Nuisance Abatement Officer	<u>1080</u>	<u>0.52</u>	<u>1040</u>	<u>0.50</u>
	1080	0.52	1040	0.50

---

THIS PAGE INTENTIONALLY LEFT BLANK

---

---

# **CONVENTION AND VISITOR'S BUREAU FUND**

---

## **CONVENTION AND VISITOR'S FUND BUDGET HIGHLIGHTS**

### **ACTIVITIES**

The Convention and Visitor's Fund provides for the receipt and disbursement of all funds in conjunction with the hotel/motel/restaurant tax. This is a gross receipt tax that provides for a rate of 4% on hotel/motel rooms and 1% on restaurants. The funds may be used for conventions and tourism purposes, as well as other uses authorized by the ordinance and law.

### **REVENUE/RATE INCREASES**

There is no tax increase within the proposed 2016 -2017 Convention and Visitor's Fund.

### **REVENUE/EXPENDITURE PROJECTIONS**

Hotel and motel gross receipt taxes are projected at 2.3% above fiscal year ending June 30, 2015 actual levels. Restaurant gross receipt taxes are projected at 6.1% above fiscal year ending June 30, 2015 actual levels. These taxes are projected to grow 3% annually in the future.

Future expenditures from this fund are controlled by an agreement between the City and MidAmerican Hotels Corporation. This budget includes payments to the Cape Chamber of Commerce for operation of the Convention and Visitors Bureau, debt payments on bonds issued to fund the construction of a new indoor sports complex, and transfers to the City's Public Safety Trust II to make payments on bonds issued to fund the construction of a new police headquarters. Amounts shown as capital outlays represent excess hotel and motel gross receipts that are to be used for improvements to Cape Splash. Transfers in excess of \$333,333 are amounts proposed to subsidize the operations of the new indoor sports complex. All of these transactions are allowed by the previous agreement.

# CONVENTION VISITORS FUND

## 2016-2017 RESOURCES

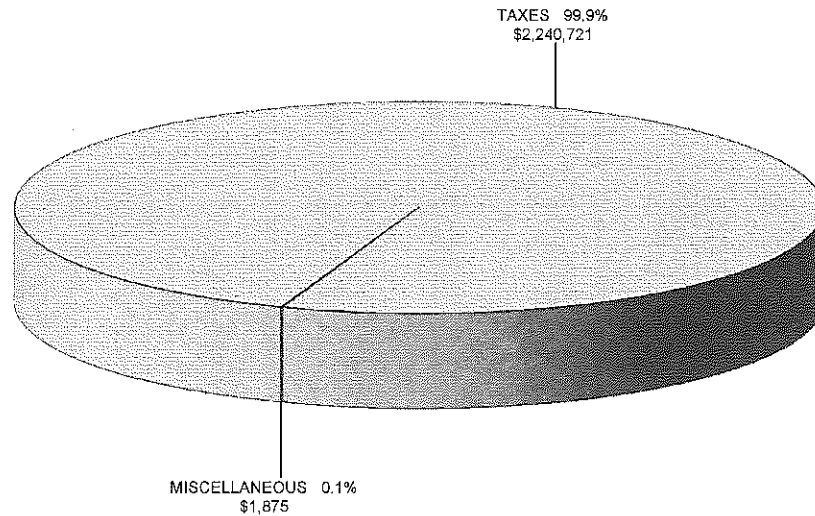

# CONVENTION VISITORS FUND

## 2016-2017 EXPENDITURES

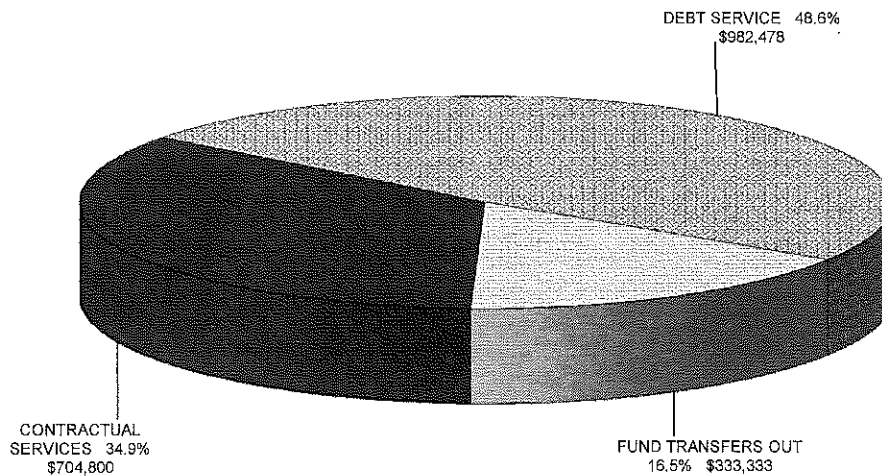

CONVENTION VISITORS FUND  
BUDGET BY MAJOR OBJECT

	<u>2013-14</u> <u>ACTUAL</u>	<u>2014-15</u> <u>ACTUAL</u>	<u>2015-16</u> <u>BUDGET</u>	<u>2016-17</u> <u>BUDGET</u>
REVENUE SOURCE:				
TAXES	\$2,019,802	\$2,136,404	\$2,141,710	\$2,240,721
LICENSES AND PERMITS	-	-	-	-
INTERGOVERN REVENUE	-	-	-	-
SERVICE CHARGES	-	-	-	-
FINES AND FORFEITS	-	-	-	-
MISCELLANEOUS	951	6,959	1,000	1,875
OTHER FINANCING	-	-	-	-
	\$2,020,753	\$2,143,363	\$2,142,710	\$2,242,596
EXPENSE OBJECT:				
PERSONNEL SERVICES	\$ -	\$ -	\$ -	\$ -
MATERIALS & SUPPLIES	21,495	20,070	17,880	-
CONTRACTUAL SERVICES	669,726	753,645	695,200	704,800
GENERAL OPERATIONS	-	-	-	-
CAPITAL OUTLAY	-	1,181,883	1,268,025	-
SPECIAL PROJECTS	1,333,081	(19,038)	-	-
DEBT SERVICE	-	-	-	982,478
	\$2,024,302	\$1,936,560	\$1,981,105	\$1,687,278
FUND TRANSFERS IN	-	-	-	-
FUND TRANSFERS OUT	-	-	333,333	333,333
PROJECTED REVENUE				
OVER(UNDER) BUDGET			64,125	
PROJECTED EXPENDITURES				
UNDER(OVER) BUDGET			120,140	
RESERVED FUND BALANCE				
DECREASE(INCREASE)			-	-
EMERGENCY RESERVE FUND BALANCE				
DECREASE(INCREASE)				(146,130)
BEGINNING UNRESERVED FUND				
BALANCE			363,522	376,059
ENDING UNRESERVED FUND				
BALANCE			376,059	451,914
EMERGENCY RESERVE FUND			106,962	253,092
RESERVED FOR RIVER CAMPUS PROJECT		-	-	-

CONVENTION VISITORS FUND  
BUDGET PROJECTIONS

	<u>2017-18</u> <u>PROJECTED</u>	<u>2018-19</u> <u>PROJECTED</u>	<u>2019-20</u> <u>PROJECTED</u>	<u>2020-21</u> <u>PROJECTED</u>	<u>2021-22</u> <u>PROJECTED</u>
REVENUE SOURCE:					
TAXES	\$2,307,943	\$2,377,181	\$ 2,448,496	\$ 2,521,951	\$ 2,597,610
LICENSES AND PERMITS	-	-	-	-	-
INTERGOVERN REVENUE	-	-	-	-	-
SERVICE CHARGES	-	-	-	-	-
FINES AND FORFEITS	-	-	-	-	-
MISCELLANEOUS	9,879	12,332	15,316	18,940	23,175
OTHER FINANCING	-	-	-	-	-
<b>TOTAL REVENUE</b>	<u>\$2,317,822</u>	<u>\$ 2,389,513</u>	<u>\$ 2,463,812</u>	<u>\$ 2,540,891</u>	<u>\$ 2,620,785</u>
EXPENSE OBJECT:					
PERSONNEL SERVICES	\$ -	\$ -	\$ -	\$ -	\$ -
MATERIALS & SUPPLIES	-	-	-	-	-
CONTRACTUAL SERVICES	724,444	744,677	765,518	786,983	809,093
GENERAL OPERATIONS	-	-	-	-	-
CAPITAL OUTLAY	41,585	44,332	47,162	50,077	53,079
SPECIAL PROJECTS	-	-	-	-	-
DEBT SERVICE	537,990	552,640	701,890	853,015	960,890
<b>TOTAL EXPENSES</b>	<u>\$1,304,019</u>	<u>\$ 1,341,649</u>	<u>\$ 1,514,570</u>	<u>\$ 1,690,075</u>	<u>\$ 1,823,062</u>
FUND TRANSFERS IN	-	-	-	-	-
FUND TRANSFERS OUT	833,333	833,333	683,333	533,333	433,333
PROJECTED REVENUE OVER(UNDER) BUDGET					
PROJECTED EXPENDITURES UNDER(OVER) BUDGET					
RESERVED FUND BALANCE DECREASE(INCREASE)					
EMERGENCY RESERVE FUND BALANCE DECREASE(INCREASE)	57,489	(5,644)	(25,938)	(26,326)	(19,948)
BEGINNING UNRESERVED FUND BALANCE	451,914	689,873	898,760	1,138,731	1,429,888
ENDING UNRESERVED FUND BALANCE	<u>689,873</u>	<u>898,760</u>	<u>1,138,731</u>	<u>1,429,888</u>	<u>1,774,331</u>



CONVENTION/VISITOR BUREAU FUND REVENUE

	2013-14 <u>ACTUAL</u>	2014-15 <u>ACTUAL</u>	2015-16 <u>BUDGET</u>	2016-17 <u>PROPOSED</u>
Hotel / Motel Tax	\$ 678,535	\$ 727,263	\$ 727,260	\$ 743,717
Restaurant Tax	1,338,696	1,407,487	1,412,700	1,494,504
Osage Caterer Fee	<u>2,571</u>	<u>1,654</u>	<u>1,750</u>	<u>2,500</u>
	2,019,802	2,136,404	2,141,710	2,240,721
Interest on Overnight Invmt	<u>951</u>	<u>6,959</u>	<u>1,000</u>	<u>1,875</u>
	951	6,959	1,000	1,875
	<u>\$2,020,753</u>	<u>\$2,143,363</u>	<u>\$2,142,710</u>	<u>\$2,242,596</u>

---

CONVENTION & VISITORS BUREAU

BUDGET BY MAJOR OBJECT

	2013-14 <u>ACTUAL</u>	2014-15 <u>ACTUAL</u>	2015-16 <u>BUDGET</u>	2016-17 <u>PROPOSED</u>
PERSONNEL COSTS	\$ -	\$ -	\$ -	\$ -
MATERIALS AND SUPPLIES	21,495	20,070	17,880	-
CONTRACTUAL SERVICES	669,726	753,645	695,200	704,800
GENERAL OPERATIONS	-	-	-	-
CAPITAL EXPENDITURES	-	1,181,883	1,268,025	-
SPECIAL PROJECTS	1,333,081	(19,038)	-	-
DEBT PAYMENTS	-	-	-	982,478
TRANSFERS	-	-	333,333	333,333
	<u>\$2,024,302</u>	<u>\$1,936,560</u>	<u>\$2,314,438</u>	<u>\$2,020,611</u>

---

THIS PAGE INTENTIONALLY LEFT BLANK

---

---

# **DOWNTOWN BUSINESS DISTRICT FUND**

---

**DOWNTOWN BUSINESS DISTRICT FUND**  
**BUDGET HIGHLIGHTS**

**ACTIVITIES**

The Downtown Business District Fund is financed by a separate tax levy, and a City Council appointed board make recommendations for the expenditures for the revenues within this district.

**PROGRAM/SERVICE ADJUSTMENTS**

Provides for a one-year contract with Redevelopment Corporation for certain improvements to the Downtown area.

**REVENUE/RATE INCREASES**

There is no tax increase within the proposed 2016-2017 Downtown Business District Fund.

**DOWNTOWN BUSINESS DISTRICT FUND  
2016-2017 RESOURCES**

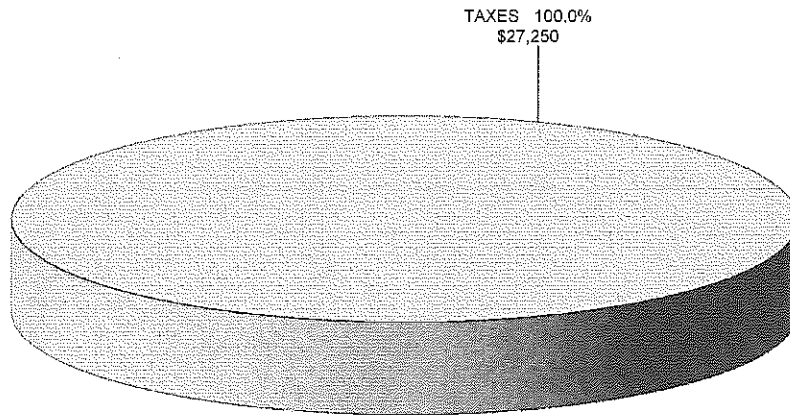

**DOWNTOWN BUSINESS DISTRICT FUND  
2016-2017 EXPENDITURES**

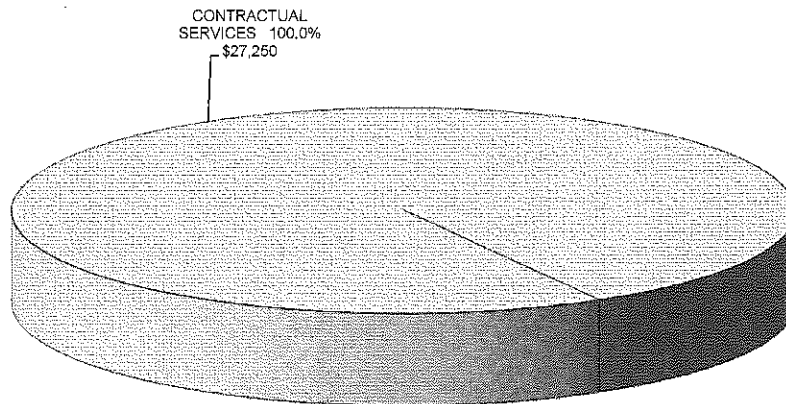

DOWNTOWN BUSINESS DISTRICT FUND  
BUDGET BY MAJOR OBJECT

	2013-14 <u>ACTUAL</u>	2014-15 <u>ACTUAL</u>	2015-16 <u>BUDGET</u>	2016-17 <u>BUDGET</u>
REVENUE SOURCE:				
TAXES	\$31,759	\$26,002	\$26,930	\$27,250
LICENSES AND PERMITS	-	-	-	-
INTERGOVERN REVENUE	-	12,000	-	-
SERVICE CHARGES	-	-	-	-
FINES AND FORFEITS	-	-	-	-
MISCELLANEOUS	802	1,172	500	-
OTHER FINANCING	-	-	-	-
	<hr/>	<hr/>	<hr/>	<hr/>
TOTAL REVENUE	\$32,561	\$39,174	\$27,430	\$27,250
EXPENSE OBJECT:				
PERSONNEL SERVICES	\$ -	\$ -	\$ -	\$ -
MATERIALS & SUPPLIES	-	-	-	-
CONTRACTUAL SERVICES	10,122	25,081	27,430	27,250
GENERAL OPERATIONS	-	-	-	-
CAPITAL OUTLAY	-	-	-	-
SPECIAL PROJECTS	-	-	-	-
DEBT SERVICE	-	-	-	-
	<hr/>	<hr/>	<hr/>	<hr/>
TOTAL EXPENSES	\$ 10,122	\$ 25,081	\$ 27,430	\$ 27,250
FUND TRANSFERS IN	-	-	-	-
FUND TRANSFERS OUT	-	-	-	-
PROJECTED REVENUE				
OVER(UNDER) BUDGET			1,640	
PROJECTED EXPENDITURES				
UNDER(OVER) BUDGET			2,680	
RESERVED FUND BALANCE				
DECREASE(INCREASE)				
EMERGENCY RESERVE FUND BALANCE				
DECREASE(INCREASE)			-	-
BEGINNING UNRESERVED FUND				
BALANCE			93,154	97,474
ENDING UNRESERVED FUND				
BALANCE			<u>97,474</u>	<u>97,474</u>
EMERGENCY RESERVE FUND			<hr/> <hr/>	<hr/> <hr/>

DOWNTOWN BUSINESS DISTRICT FUND

	2013-14 <u>ACTUAL</u>	2014-15 <u>ACTUAL</u>	2015-16 <u>BUDGET</u>	2016-17 <u>PROPOSED</u>
Real Estate Tax	\$ 24,209	\$ 24,416	\$ 24,250	\$ 24,600
Intangible Tax	2	430	430	2,650
Delinquent Real Estate Tax	5,937	792	750	-
Penalty on Delinquent R.E. Tax	<u>1,611</u>	<u>364</u>	<u>1,500</u>	<u>-</u>
	31,759	26,002	26,930	27,250
Fed indirect op-Transportation	-	8,000	-	-
Misc local operating grants	<u>-</u>	<u>4,000</u>	<u>-</u>	<u>-</u>
	-	12,000	-	-
Interest on Overnight Investment:	<u>802</u>	<u>1,172</u>	<u>500</u>	<u>-</u>
	802	1,172	500	-
	<u>\$32,561</u>	<u>\$39,174</u>	<u>\$27,430</u>	<u>\$27,250</u>



---

DOWNTOWN BUSINESS DISTRICT FUND

BUDGET BY MAJOR OBJECT

	2013-14 <u>ACTUAL</u>	2014-15 <u>ACTUAL</u>	2015-16 <u>BUDGET</u>	2016-17 <u>PROPOSED</u>
PERSONNEL COSTS	\$ -	\$ -	\$ -	\$ -
MATERIALS AND SUPPLIES	-	-	-	-
CONTRACTUAL SERVICES	10,122	25,081	27,430	27,250
GENERAL OPERATIONS	-	-	-	-
CAPITAL EXPENDITURES	-	-	-	-
SPECIAL PROJECTS	-	-	-	-
DEBT PAYMENTS	-	-	-	-
TRANSFERS	-	-	-	-
	<u>\$10,122</u>	<u>\$25,081</u>	<u>\$27,430</u>	<u>\$27,250</u>

---

**PUBLIC  
SAFETY  
TRUST  
FUND**

---

**PUBLIC SAFETY TRUST FUND**  
**BUDGET HIGHLIGHTS**

**ACTIVITIES**

The Public Safety Trust Fund is a fund established to account for transfers received from the General Fund that is equal to the amount of Fire operating expenses offset by transfers received by the General Fund from the Fires Sales Tax Trust Fund. These revenues can only be used to offset Public Safety operating and capital expenditures.

**REVENUE/EXPENDITURE PROJECTIONS**

No revenue is included in this budget. A \$25,000 allowance is included in this budget for possible cleanup and upgrade costs of the fire training site. The capital portion of the fire sales tax originally approved in 2004 was set to expire during the current year but was extended by voters to December 31, 2035. A new Public Safety Trust Fund II will be used to account for all transfers related to the Fire Sale Tax after March 31, 2014.

PUBLIC SAFETY TRUST FUND  
BUDGET BY MAJOR OBJECT

	<u>2013-14</u> <u>ACTUAL</u>	<u>2014-15</u> <u>ACTUAL</u>	<u>2015-16</u> <u>BUDGET</u>	<u>2016-17</u> <u>BUDGET</u>
REVENUE SOURCE:				
TAXES	\$ -	\$ -	\$ -	\$ -
LICENSES AND PERMITS	-	-	-	-
INTERGOVERN REVENUE	-	-	-	-
SERVICE CHARGES	-	-	-	-
FINES AND FORFEITS	-	-	-	-
MISCELLANEOUS	16,880	14,220	-	-
OTHER FINANCING	<u>3,521</u>	<u>-</u>	<u>-</u>	<u>-</u>
TOTAL REVENUE	\$ 20,401	\$ 14,220	\$ -	\$ -
EXPENSE OBJECT:				
PERSONNEL SERVICES	\$ -	\$ -	\$ -	\$ -
MATERIALS & SUPPLIES	35,243	12,232	-	-
CONTRACTUAL SERVICES	-	-	-	-
GENERAL OPERATIONS	-	-	-	25,000
CAPITAL OUTLAY	781,417	34,847	-	-
SPECIAL PROJECTS	-	-	-	-
DEBT SERVICE	<u>712,972</u>	<u>1,390,743</u>	<u>-</u>	<u>-</u>
TOTAL EXPENSES	\$ 1,529,631	\$ 1,437,823	\$ -	\$ 25,000
FUND TRANSFERS IN	2,302,317	1,754,501	-	-
FUND TRANSFERS OUT	1,151,159	877,250	-	-
PROJECTED REVENUE OVER(UNDER) BUDGET			24,165	
PROJECTED EXPENDITURES UNDER(OVER) BUDGET			(22,432)	
RESERVED FUND BALANCE DECREASE(INCREASE)				
EMERGENCY RESERVE FUND BALANCE DECREASE(INCREASE)				-
BEGINNING UNRESERVED FUND BALANCE			47,698	49,431
ENDING UNRESERVED FUND BALANCE			<u>49,431</u>	<u>24,431</u>
EMERGENCY RESERVE FUND			<u>\$ -</u>	<u>\$ -</u>

PUBLIC SAFETY TRUST FUND

	2013-14 ACTUAL	2014-15 ACTUAL	2015-16 BUDGET	2016-17 PROPOSED
Interest on Overnight Investments	<u>\$ 16,880</u>	<u>\$ 14,220</u>	<u>\$ -</u>	<u>\$ -</u>
	16,880	14,220	-	-
Sale of Assets (Governmental)	<u>3,521</u>	<u>-</u>	<u>-</u>	<u>-</u>
	3,521	-	-	-
Transfers In -General	<u>2,302,317</u>	<u>1,754,501</u>	<u>-</u>	<u>-</u>
	2,302,317	1,754,501	-	-
	<u><u>\$2,322,718</u></u>	<u><u>\$1,768,721</u></u>	<u><u>\$ -</u></u>	<u><u>\$ -</u></u>

---

PUBLIC SAFETY TRUST FUND

BUDGET BY MAJOR OBJECT

	2013-14 <u>ACTUAL</u>	2014-15 <u>ACTUAL</u>	2015-16 <u>BUDGET</u>	2016-17 <u>PROPOSED</u>
PERSONNEL COSTS	\$ -	\$ -	\$ -	\$ -
MATERIALS AND SUPPLIES	35,243	12,232	-	-
CONTRACTUAL SERVICES	-	-	-	-
GENERAL OPERATIONS	-	-	-	25,000
CAPITAL EXPENDITURES	781,417	34,847	-	-
SPECIAL PROJECTS	-	-	-	-
DEBT PAYMENTS	712,972	1,390,743	-	-
TRANSFERS	<u>1,151,159</u>	<u>877,250</u>	<u>-</u>	<u>-</u>
	<u>\$2,680,790</u>	<u>\$2,315,073</u>	<u>\$ -</u>	<u>\$ 25,000</u>

---

THIS PAGE INTENTIONALLY LEFT BLANK

---

---

**PUBLIC  
SAFETY  
TRUST  
FUND  
II**



---

## **PUBLIC SAFETY TRUST FUND II** **BUDGET HIGHLIGHTS**

### **ACTIVITIES**

The Public Safety Trust Fund II is a fund established to account for transfers received from the General Fund that is equal to the amount of Fire operating expenses offset by transfers received by the General Fund from the Fires Sales Tax Trust Fund after March 31, 2014. These revenues can only be used to offset Public Safety operating and capital expenditures.

### **REVENUE/EXPENDITURE PROJECTIONS**

This budget includes transfers from the General Fund totaling \$2,588,335 and from the Convention and Tourism Fund totaling \$333,333. This budget includes \$254,286 for police vehicle purchases, \$1,126,403 for debt service on bonds issued to build a new police headquarter, replacement and relocation of fire station #4, upgrades to fire stations #1 and #2, replacement of fire apparatus, and \$1,294,115 for transfers to the General Fund to cover various public safety operating expenses.

During the subsequent 5 years transfers from the General Fund and transfers to the General Fund are projected to increase 3% annually while transfers from the Convention and Tourism fund are projected remain at \$333,333 annually. Expenditures during the subsequent 5 years include required debt service payments and capital purchases equal to the amount of excess projected revenue.

PUBLIC SAFETY TRUST FUND II  
BUDGET BY MAJOR OBJECT

	<u>2013-14</u> <u>ACTUAL</u>	<u>2014-15</u> <u>ACTUAL</u>	<u>2015-16</u> <u>BUDGET</u>	<u>2016-17</u> <u>BUDGET</u>
REVENUE SOURCE:				
TAXES	\$ -	\$ -	\$ -	\$ -
LICENSES AND PERMITS	-	-	-	-
INTERGOVERN REVENUE	-	-	-	-
SERVICE CHARGES	-	-	-	-
FINES AND FORFEITS	-	-	-	-
MISCELLANEOUS	-	132	-	-
OTHER FINANCING	-	-	-	-
	-	-	-	-
TOTAL REVENUE	\$ -	\$ 132	\$ -	\$ -
EXPENSE OBJECT:				
PERSONNEL SERVICES	\$ -	\$ -	\$ -	\$ -
MATERIALS & SUPPLIES	-	35,084	-	-
CONTRACTUAL SERVICES	-	4,396	-	-
GENERAL OPERATIONS	-	-	-	-
CAPITAL OUTLAY	-	258,320	86,256	254,286
SPECIAL PROJECTS	-	-	-	-
DEBT SERVICE	-	14	-	1,269,403
	-	14	-	1,269,403
TOTAL EXPENSES	\$ -	\$ 297,814	\$ 86,256	\$ 1,523,689
FUND TRANSFERS IN	-	755,333	2,835,333	2,921,668
FUND TRANSFERS OUT	-	377,667	1,251,000	1,294,115
PROJECTED REVENUE				
OVER(UNDER) BUDGET			108,806	
PROJECTED EXPENDITURES				
UNDER(OVER) BUDGET			(1,267,228)	
RESERVED FUND BALANCE				
DECREASE(INCREASE)				
EMERGENCY RESERVE FUND BALANCE				
DECREASE(INCREASE)				-
BEGINNING UNRESERVED FUND				
BALANCE			79,984	419,639
ENDING UNRESERVED FUND				
BALANCE			419,639	523,503
EMERGENCY RESERVE FUND			\$ -	\$ -

PUBLIC SAFETY TRUST FUND II  
BUDGET PROJECTIONS

	2017-18 <u>PROJECTED</u>	2018-19 <u>PROJECTED</u>	2019-20 <u>PROJECTED</u>	2020-21 <u>PROJECTED</u>	2021-22 <u>PROJECTED</u>
REVENUE SOURCE:					
TAXES	\$ -	\$ -	\$ -	\$ -	\$ -
LICENSES AND PERMITS	-	-	-	-	-
INTERGOVERN REVENUE	-	-	-	-	-
SERVICE CHARGES	-	-	-	-	-
FINES AND FORFEITS	-	-	-	-	-
MISCELLANEOUS	-	-	-	-	-
OTHER FINANCING	-	-	-	-	-
<b>TOTAL REVENUE</b>	<b>\$ -</b>	<b>\$ -</b>	<b>\$ -</b>	<b>\$ -</b>	<b>\$ -</b>
EXPENSE OBJECT:					
PERSONNEL SERVICES	\$ -	\$ -	\$ -	\$ -	\$ -
MATERIALS & SUPPLIES	-	-	-	-	-
CONTRACTUAL SERVICES	-	-	-	-	-
GENERAL OPERATIONS	-	-	-	-	-
CAPITAL OUTLAY	385,922	415,410	446,773	475,096	510,442
SPECIAL PROJECTS	-	-	-	-	-
DEBT SERVICE	1,280,349	1,290,849	1,300,674	1,314,774	1,323,124
<b>TOTAL EXPENSES</b>	<b>\$ 1,666,271</b>	<b>\$ 1,706,259</b>	<b>\$1,747,447</b>	<b>\$ 1,789,870</b>	<b>\$ 1,833,566</b>
FUND TRANSFERS IN	2,999,209	3,079,185	3,161,561	3,246,407	3,333,799
FUND TRANSFERS OUT	1,332,938	1,372,926	1,414,114	1,456,537	1,500,233
PROJECTED REVENUE OVER(UNDER) BUDGET					
PROJECTED EXPENDITURES UNDER(OVER) BUDGET					
RESERVED FUND BALANCE DECREASE(INCREASE)					
EMERGENCY RESERVE FUND BALANCE DECREASE(INCREASE)	(192,052)	(1,575)	(1,474)	(2,115)	(1,253)
BEGINNING UNRESERVED FUND BALANCE	523,503	331,451	329,876	328,402	326,287
ENDING UNRESERVED FUND BALANCE	<u>331,451</u>	<u>329,876</u>	<u>328,402</u>	<u>326,287</u>	<u>325,034</u>
EMERGENCY RESERVE FUND	<u>192,052</u>	<u>193,627</u>	<u>195,101</u>	<u>197,216</u>	<u>198,469</u>

PUBLIC SAFETY TRUST FUND II

	2013-14 ACTUAL	2014-15 ACTUAL	2015-16 BUDGET	2016-17 PROPOSED
Interest on Overnight Invmts	\$ -	132	-	-
	-	132	-	-
Transfers In -General	-	755,333	2,502,000	2,588,335
Transfer from CVB	-	-	333,333	333,333
	-	755,333	2,835,333	2,921,668
	<u>\$ -</u>	<u>\$ 755,465</u>	<u>\$2,835,333</u>	<u>\$2,921,668</u>

---

PUBLIC SAFETY TRUST FUND II

BUDGET BY MAJOR OBJECT

	2013-14 <u>ACTUAL</u>	2014-15 <u>ACTUAL</u>	2015-16 <u>BUDGET</u>	2016-17 <u>PROPOSED</u>
PERSONNEL COSTS	\$ -	\$ -	\$ -	\$ -
MATERIALS AND SUPPLIES	-	35,084	-	-
CONTRACTUAL SERVICES	-	4,396	-	-
GENERAL OPERATIONS	-	-	-	-
CAPITAL EXPENDITURES	-	258,320	86,256	254,286
SPECIAL PROJECTS	-	-	-	-
DEBT PAYMENTS	-	14	-	1,269,403
TRANSFERS	-	377,667	1,251,000	1,294,115
	<u>\$ -</u>	<u>\$ 675,481</u>	<u>\$1,337,256</u>	<u>\$2,817,804</u>

---

# CASINO REVENUE FUND

---

**CASINO REVENUE FUND**  
**BUDGET HIGHLIGHTS**

**ACTIVITIES**

This fund will account for the receipt of all revenues associated with the Isle of Capri Casino that opened in October 2012. During the fiscal year ending June 30, 2011 \$2,000,000 in revenue from sale of City property to the Isle of Capri was placed in this fund. This money was subsequently transferred to the debt service fund to pay off debt early and to the general fund to replenish the emergency reserve fund.

**REVENUE/EXPENDITURE PROJECTIONS**

This budget assumes tax revenue from the Casino, interest revenue, and a \$190,000 matching transfer to the riverfront economic development fund. It also provides for a \$460,000 payment on the Industrial Park loan, \$96,000 for revenue share payments to adjacent communities and \$58,107 for various small capital expenditures for the police and fire divisions.

This budget assumes that the tax revenue for fiscal year ending June 30, 2017 will be allocated as follows: actual amount needed to match Casino's contribution to the riverfront economic development fund; 3% for adjacent communities; 10% for legacy; 20% for innovation; and 40% for capital projects.

**CASINO REVENUE FUND  
2016-2017 RESOURCES**

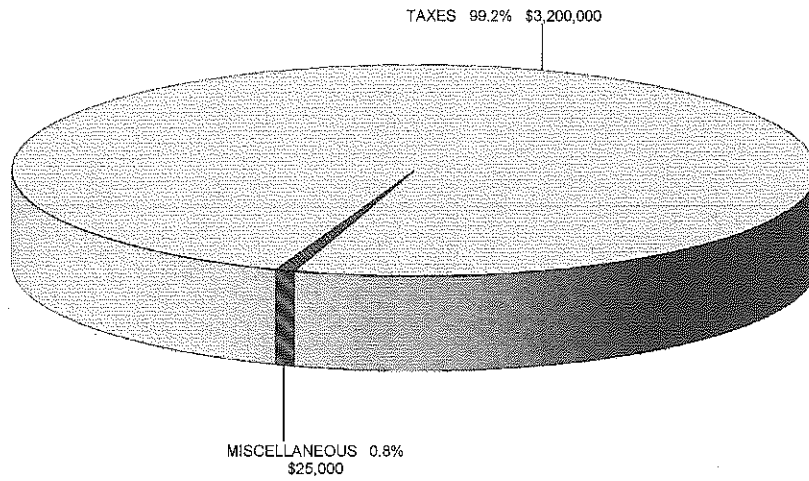

**CASINO REVENUE FUND  
2016-2017 EXPENDITURES**

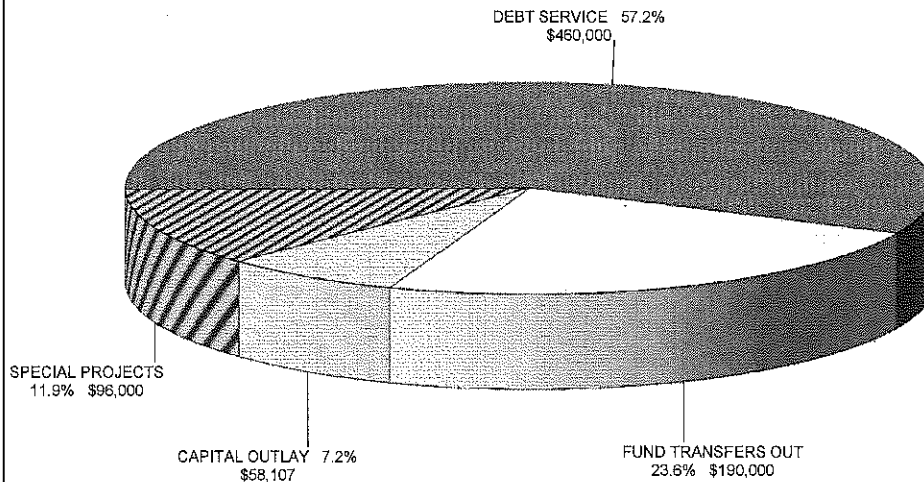



CASINO REVENUE FUND  
BUDGET BY MAJOR OBJECT

	2013-14 <u>ACTUAL</u>	2014-15 <u>ACTUAL</u>	2015-16 <u>BUDGET</u>	2016-17 <u>BUDGET</u>
REVENUE SOURCE:				
TAXES	3,200,901	\$ 3,268,825	\$ 3,200,000	\$ 3,200,000
LICENSES AND PERMITS	-	-	-	-
INTERGOVERN REVENUE	-	-	-	-
SERVICE CHARGES	-	-	-	-
FINES AND FORFEITS	-	-	-	-
MISCELLANEOUS	33,527	56,469	25,000	25,000
OTHER FINANCING	<u>71,608</u>	<u>-</u>	<u>-</u>	<u>-</u>
TOTAL REVENUE	3,306,036	\$ 3,325,294	\$ 3,225,000	\$ 3,225,000
EXPENSE OBJECT:				
PERSONNEL SERVICES	\$ -	\$ -	\$ -	\$ -
MATERIALS & SUPPLIES	-	4,360	-	-
CONTRACTUAL SERVICES	143	22,864	-	-
GENERAL OPERATIONS	47,928	2,009	-	-
CAPITAL OUTLAY	1,558,416	394,109	4,837,638	58,107
SPECIAL PROJECTS	92,299	601,358	96,000	96,000
DEBT SERVICE	<u>460,000</u>	<u>460,000</u>	<u>460,000</u>	<u>460,000</u>
TOTAL EXPENSES	<u>2,158,786</u>	<u>\$ 1,484,699</u>	<u>\$ 5,393,638</u>	<u>\$ 614,107</u>
FUND TRANSFERS IN	270,000	260,000	-	-
FUND TRANSFERS OUT	316,520	486,003	185,000	190,000
PROJECTED REVENUE				
OVER(UNDER) BUDGET			383,273	
PROJECTED EXPENDITURES				
UNDER(OVER) BUDGET			472,035	
RESERVED FUND BALANCE				
DECREASE(INCREASE)				
EMERGENCY RESERVE FUND BALANCE				
DECREASE(INCREASE)				
BEGINNING UNRESERVED FUND				
BALANCE			3,874,355	2,376,025
ENDING UNRESERVED FUND				
BALANCE			<u>2,376,025</u>	<u>4,796,918</u>
EMERGENCY RESERVE FUND			<u>-</u>	<u>-</u>

CASINO REVENUE FUND

	2013-14 ACTUAL	2014-15 ACTUAL	2015-16 BUDGET	2016-17 PROPOSED
Gaming Gross Receipts Tax	<u>3,200,901</u>	<u>\$3,268,825</u>	<u>3,200,000</u>	<u>\$3,200,000</u>
	3,200,901	3,268,825	3,200,000	3,200,000
Interest on Overnight Investments	<u>33,527</u>	<u>56,469</u>	<u>25,000</u>	<u>25,000</u>
	33,527	56,469	25,000	25,000
Sale of Assets (Governmental)	<u>71,608</u>	<u>-</u>	<u>-</u>	<u>-</u>
	71,608	-	-	-
Transfers in General Fund	260,000	260,000	-	-
Transfer fm Pks & Rec Foundation	<u>10,000</u>	<u>-</u>	<u>-</u>	<u>-</u>
	270,000	260,000	-	-
	<u>\$3,576,036</u>	<u>\$3,585,294</u>	<u>3,225,000</u>	<u>\$3,225,000</u>

CASINO REVENUE FUND

BUDGET BY MAJOR OBJECT

	2013-14 <u>ACTUAL</u>	2014-15 <u>ACTUAL</u>	2015-16 <u>BUDGET</u>	2016-17 <u>PROPOSED</u>
PERSONNEL COSTS	\$ -	\$ -	\$ -	\$ -
MATERIALS AND SUPPLIES	-	4,360	-	-
CONTRACTUAL SERVICES	143	22,864	-	-
GENERAL OPERATIONS	47,928	2,009	-	-
CAPITAL EXPENDITURES	1,558,416	394,109	4,837,638	58,107
SPECIAL PROJECTS	92,299	601,358	96,000	96,000
DEBT PAYMENTS	460,000	460,000	460,000	460,000
TRANSFERS	316,520	486,003	185,000	190,000
	<u>\$2,475,306</u>	<u>\$1,970,702</u>	<u>\$5,578,638</u>	<u>\$804,107</u>

---

# **RIVERFRONT REGION ECONOMIC DEVELOPMENT FUND**

---

**RIVERFRONT REGION ECONOMIC DEVELOPMENT FUND**  
**BUDGET HIGHLIGHTS**

**ACTIVITIES**

This fund was established by a development agreement between IOC-Cape Girardeau LLC (Developer) and the City. The developer shall pay monthly .3% of its gross gaming revenue into this fund for improvements, economic development, and other public purposes benefiting the downtown commercial and riverfront areas. The developer's monthly payments are only required if the City funds, or makes a binding commitment to fund an equal amount to be deposited into this fund. The developer prepaid \$250,000 of its future liability into this fund during the fiscal year ending June 30, 2012 to be used to fund a Way finding Signage Project. The City was not required to match this contribution

**REVENUE/EXPENDITURE PROJECTIONS**

This budget includes \$190,000 in revenue that is expected to be received from the developer during the current fiscal year and matching funding from the City. This budget allocates 30% of the total estimated revenue to be used to fund the operations of Old Town Cape, \$20,000 Bill Emerson Bridge lighting, \$6,000 for downtown parking, \$50,000 to be used on a strategic development plan and \$670,000 for currently undetermined future development projects.

**RIVERFRONT REGION ECONOMIC  
DEVELOPMENT  
2016-2017 RESOURCES**

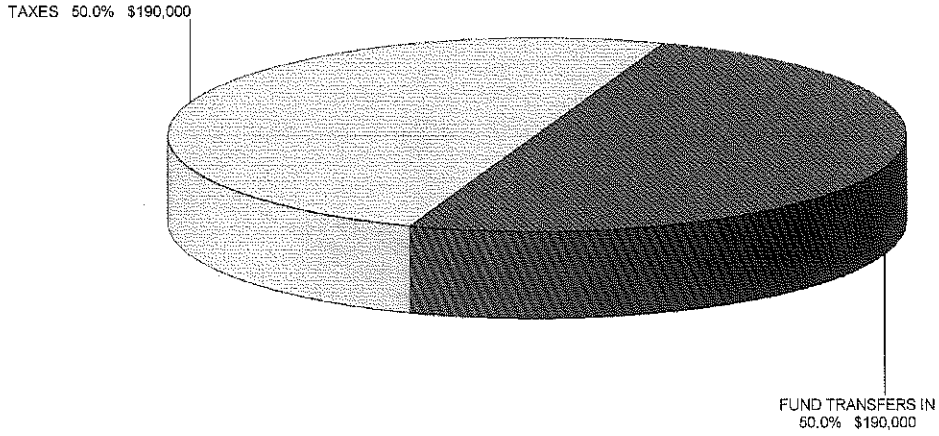

**RIVERFRONT REGION ECONOMIC  
DEVELOPMENT  
2016-2017 EXPENDITURES**

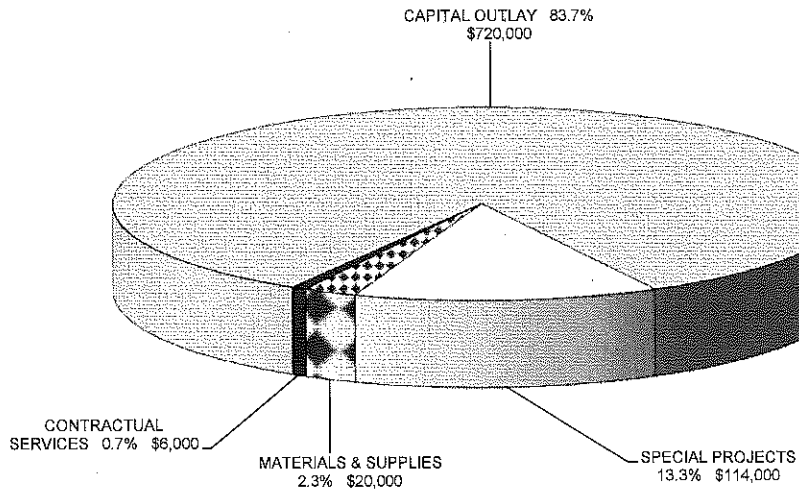

RIVERFRONT REGION ECONOMIC DEVELOPMENT  
BUDGET BY MAJOR OBJECT

	2013-14 <u>ACTUAL</u>	2014-15 <u>ACTUAL</u>	2015-16 <u>BUDGET</u>	2016-17 <u>BUDGET</u>
REVENUE SOURCE:				
TAXES	\$ 56,520	\$ 188,356	\$ 185,000	\$ 190,000
LICENSES AND PERMITS	-	-	-	-
INTERGOVERN REVENUE	-	-	-	-
SERVICE CHARGES	-	-	-	-
FINES AND FORFEITS	-	-	-	-
MISCELLANEOUS	76	1,994	-	-
OTHER FINANCING	-	-	-	-
	<hr/>	<hr/>	<hr/>	<hr/>
TOTAL REVENUE	\$ 56,596	\$ 190,350	\$ 185,000	\$ 190,000
EXPENSE OBJECT:				
PERSONNEL SERVICES	\$ -	\$ -	\$ -	\$ -
MATERIALS & SUPPLIES	-	-	-	20,000
CONTRACTUAL SERVICES	-	-	-	6,000
GENERAL OPERATIONS	-	-	-	-
CAPITAL OUTLAY	-	-	344,200	720,000
SPECIAL PROJECTS	-	100,800	111,000	114,000
DEBT SERVICE	105	-	-	-
	<hr/>	<hr/>	<hr/>	<hr/>
TOTAL EXPENSES	\$ 105	\$ 100,800	\$ 455,200	\$ 860,000
FUND TRANSFERS IN	56,520	171,003	185,000	190,000
FUND TRANSFERS OUT	-	-	-	-
PROJECTED REVENUE				
OVER(UNDER) BUDGET			15,000	
PROJECTED EXPENDITURES				
UNDER(OVER) BUDGET			188,200	
RESERVED FUND BALANCE				
DECREASE(INCREASE)				
EMERGENCY RESERVE FUND BALANCE				
DECREASE(INCREASE)				
BEGINNING UNRESERVED FUND				
BALANCE			365,168	483,168
ENDING UNRESERVED FUND				
BALANCE			<hr/> <u>483,168</u>	<hr/> <u>3,168</u>
EMERGENCY RESERVE FUND			<hr/> <u>-</u>	<hr/> <u>-</u>

RIVERFRONT REGIONAL ECONOMIC DEVELOPMENT FUND

	2013-14 ACTUAL	2014-15 ACTUAL	2015-16 BUDGET	2016-17 PROPOSED
Gaming Gross Receipts Tax	<u>\$ 56,520</u>	<u>\$ 188,356</u>	<u>\$ 185,000</u>	<u>\$ 190,000</u>
	56,520	188,356	185,000	190,000
Interest on Overnight Investments	<u>76</u>	<u>1,994</u>	<u>-</u>	<u>-</u>
	76	1,994	-	-
Transfer fm Casino Rev Fd	<u>56,520</u>	<u>171,003</u>	<u>185,000</u>	<u>190,000</u>
	56,520	171,003	185,000	190,000
	<u>\$ 113,116</u>	<u>\$ 361,353</u>	<u>\$ 370,000</u>	<u>\$ 380,000</u>



---

RIVERFRONT REGIONAL ECONOMIC DEVELOPMENT FUND

BUDGET BY MAJOR OBJECT

	2013-14 <u>ACTUAL</u>	2014-15 <u>ACTUAL</u>	2015-16 <u>BUDGET</u>	2016-17 <u>PROPOSED</u>
PERSONNEL COSTS	\$ -	\$ -	\$ -	\$ -
MATERIALS AND SUPPLIES	-	-	-	20,000
CONTRACTUAL SERVICES	-	-	-	6,000
GENERAL OPERATIONS	-	-	-	-
CAPITAL EXPENDITURES	-	-	344,200	720,000
SPECIAL PROJECTS	-	100,800	111,000	114,000
DEBT PAYMENTS	105	-	-	-
TRANSFERS	-	-	-	-
	<u>\$ 105</u>	<u>\$ 100,800</u>	<u>\$ 455,200</u>	<u>\$ 860,000</u>

---

# HOUSING DEVELOPMENT GRANTS

---

**HOUSING DEVELOPMENT GRANTS**  
**BUDGET HIGHLIGHTS**

**ACTIVITIES**

The Housing Development Grant Fund accounts for the revenue and expenditures associated with the rehabilitation of housing from the Community Development Block Grant Program and other programs for neighborhood housing rehabilitation. This budget includes amounts for grant revenues and expenditures for potential future awards.

Program revenue may become available for expenditure during the year. Appropriations will be made as this revenue is spent.

HOUSING DEVELOPMENT GRANTS  
BUDGET BY MAJOR OBJECT

	2013-14 <u>ACTUAL</u>	2014-15 <u>ACTUAL</u>	2015-16 <u>BUDGET</u>	2016-17 <u>BUDGET</u>
REVENUE SOURCE:				
TAXES	\$ -	\$ -	\$ -	\$ -
LICENSES AND PERMITS	-	-	-	-
INTERGOVERN REVENUE	117,062	160,996	175,000	175,000
SERVICE CHARGES	-	-	-	-
FINES AND FORFEITS	-	-	-	-
MISCELLANEOUS	10	12	-	-
OTHER FINANCING	-	-	-	-
	<u>          </u>	<u>          </u>	<u>          </u>	<u>          </u>
TOTAL REVENUE	\$ 117,072	\$ 161,008	\$ 175,000	\$ 175,000
EXPENSE OBJECT:				
PERSONNEL SERVICES	\$ -	\$ -	\$ -	\$ -
MATERIALS & SUPPLIES	-	-	-	-
CONTRACTUAL SERVICES	-	-	-	-
GENERAL OPERATIONS	-	-	-	-
CAPITAL OUTLAY	-	-	-	-
SPECIAL PROJECTS	91,356	230,711	200,000	200,000
DEBT SERVICE	517	345	-	-
	<u>          </u>	<u>          </u>	<u>          </u>	<u>          </u>
TOTAL EXPENSES	\$ 91,874	\$ 231,055	\$ 200,000	\$ 200,000
FUND TRANSFERS IN	32,762	19,745	25,000	25,000
FUND TRANSFERS OUT	-	-	-	-
PROJECTED REVENUE OVER(UNDER) BUDGET			47,490	
PROJECTED EXPENDITURES UNDER(OVER) BUDGET			(47,490)	
RESERVED FUND BALANCE DECREASE(INCREASE)				
EMERGENCY RESERVE FUND BALANCE DECREASE(INCREASE)				
BEGINNING UNRESERVED FUND BALANCE			44,231	44,231
ENDING UNRESERVED FUND BALANCE			<u>44,231</u>	<u>44,231</u>
EMERGENCY RESERVE FUND			<u>          </u>	<u>          </u>

HOUSING DEVELOPMENT GRANTS REVENUE

	2013-14 <u>ACTUAL</u>	2014-15 <u>ACTUAL</u>	2015-16 <u>BUDGET</u>	2016-17 <u>PROPOSED</u>
HUD-Neighborhood Stabilization Prog Yr 2	\$ (3,363)	\$ -	\$ 175,000	\$ 175,000
Miscellaneous Capital Grants	64,366	113,624	-	-
Program Income-Neighborhood Sta	<u>56,059</u>	<u>47,372</u>	<u>-</u>	<u>-</u>
	117,062	160,996	175,000	175,000
Interest on Overnight Inv	7	12	-	-
Miscellaneous	<u>3</u>	<u>-</u>	<u>-</u>	<u>-</u>
	10	12	-	-
Transfers In - General	30,239	19,745	25,000	25,000
Transfers In - CDBG Projects	<u>2,524</u>	<u>-</u>	<u>-</u>	<u>-</u>
	32,762	19,745	25,000	25,000
	<u>\$ 149,834</u>	<u>\$ 180,753</u>	<u>\$ 200,000</u>	<u>\$ 200,000</u>

---

HOUSING DEVELOPMENT GRANTS

BUDGET BY MAJOR OBJECT

	2013-14 <u>ACTUAL</u>	2014-15 <u>ACTUAL</u>	2015-16 <u>BUDGET</u>	2016-17 <u>PROPOSED</u>
PERSONNEL COSTS	\$ -	\$ -	\$ -	\$ -
MATERIALS AND SUPPLIES	-	-	-	-
CONTRACTUAL SERVICES	-	-	-	-
GENERAL OPERATIONS	-	-	-	-
CAPITAL EXPENDITURES	-	-	-	-
SPECIAL PROJECTS	91,356	230,711	200,000	200,000
DEBT PAYMENTS	517	345	-	-
TRANSFERS	-	-	-	-
	<u>\$ 91,874</u>	<u>\$ 231,055</u>	<u>\$ 200,000</u>	<u>\$ 200,000</u>

---

THIS PAGE INTENTIONALLY LEFT BLANK

---

---

# **MOTOR FUEL TAX FUND**



---

## **MOTOR FUEL TAX FUND BUDGET HIGHLIGHTS**

### **ACTIVITIES**

The Motor Fuel Tax Fund provides for the receipt of funds from the City's allocable portion of the state motor fuel taxes, the state sales tax on motor vehicles, the state vehicle license fees. The state motor fuel tax is 15% of the remaining net proceeds of that tax and is allocated to various incorporated cities, towns and villages within the State based on the population of that City. As stipulated in Article IV of the Missouri Constitution all taxes in this fund provide for the construction, repair, signing or lighting of roads, street and bridge projects. The only airport improvement expenses that could be approved are those for construction or repair of streets and roads within the airport property.

### **REVENUE/EXPENDITURE PROJECTIONS**

State Motor Fuel Tax revenues for fiscal year ending June 30, 2017 are projected to equal the projected revenues from fiscal year ending June 30, 2016. Revenues are anticipated to be stable over the following five years.

This budget includes \$1,445,000 transfers to the general fund and \$475,000 payments on a direct loan from the Missouri Transportation Finance Corporation. Projected annual transfers to the General Fund are \$1,160,000 for the five remaining fiscal years. \$475,000 payments to the Missouri Transportation Finance Corporation are included for the five remaining fiscal years.

The \$3,965,100 direct loan from the Missouri Transportation Finance Corporation will be used by the City as a temporary financing to construct a new bridge on South Sprigg Street. Federal Emergency Relief funding has been approved for replacement of this bridge since the previous bridge became unusable as the result of sinkholes. However, currently these funds have not been appropriated. When funds become available any principle previously paid by this fund will be reimbursed from the grant proceeds.

# MOTOR FUEL TAX FUND

## 2016-2017 RESOURCES

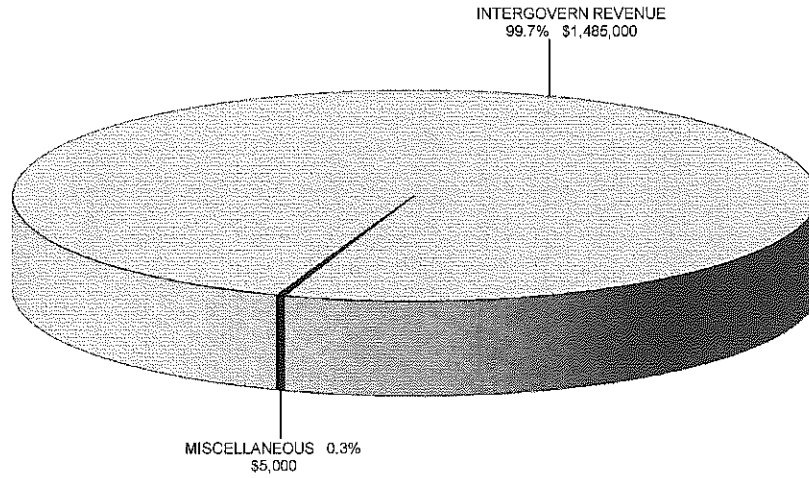

# MOTOR FUEL TAX FUND

## 2016-2017 EXPENDITURES

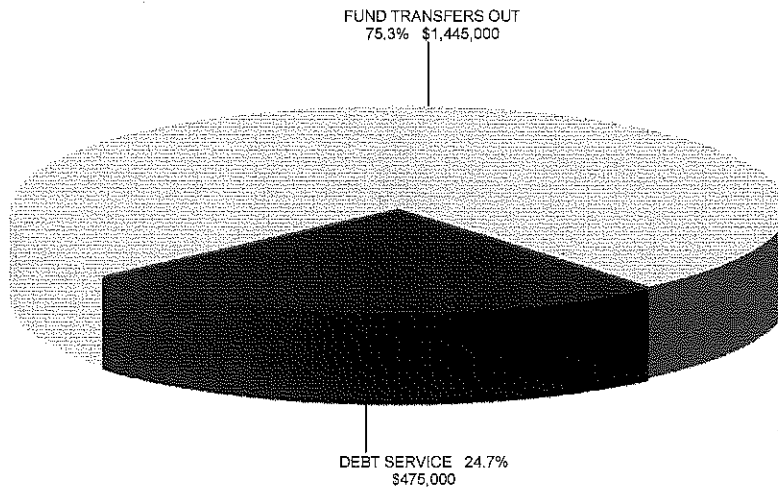

MOTOR FUEL TAX FUND  
BUDGET BY MAJOR OBJECT

	<u>2013-14</u> <u>ACTUAL</u>	<u>2014-15</u> <u>ACTUAL</u>	<u>2015-16</u> <u>BUDGET</u>	<u>2016-17</u> <u>BUDGET</u>
REVENUE SOURCE:				
TAXES	\$ -	\$ -	\$ -	\$ -
LICENSES AND PERMITS	-	-	-	-
INTERGOVERN REVENUE	1,552,663	1,599,684	1,445,000	1,485,000
SERVICE CHARGES	-	-	-	-
FINES AND FORFEITS	-	-	-	-
MISCELLANEOUS	11,064	13,298	8,887	5,000
OTHER FINANCING	<u>4,287</u>	<u>4,578</u>	<u>4,468</u>	<u>-</u>
TOTAL REVENUE	\$1,568,014	\$1,617,560	\$1,458,355	\$1,490,000
EXPENSE OBJECT:				
PERSONNEL SERVICES	\$ -	\$ -	\$ -	\$ -
MATERIALS & SUPPLIES	-	-	-	-
CONTRACTUAL SERVICES	-	-	-	-
GENERAL OPERATIONS	-	-	-	-
CAPITAL OUTLAY	365,118	273,665	-	-
SPECIAL PROJECTS	-	-	-	-
DEBT SERVICE	<u>-</u>	<u>-</u>	<u>-</u>	<u>475,000</u>
TOTAL EXPENSES	<u>\$ 365,118</u>	<u>\$ 273,665</u>	<u>\$ -</u>	<u>\$ 475,000</u>
FUND TRANSFERS IN	-	25,637	-	-
FUND TRANSFERS OUT	970,000	1,120,000	1,420,000	1,445,000
PROJECTED REVENUE OVER(UNDER) BUDGET			93,619	
PROJECTED EXPENDITURES UNDER(OVER) BUDGET			(35,000)	
RESERVED FUND BALANCE DECREASE(INCREASE)				
EMERGENCY RESERVE FUND BALANCE DECREASE(INCREASE)				
BEGINNING UNRESERVED FUND BALANCE			1,078,159	1,175,133
ENDING UNRESERVED FUND BALANCE			<u>1,175,133</u>	<u>745,133</u>
EMERGENCY RESERVE FUND			<u>-</u>	<u>-</u>

MOTOR FUEL TAX FUND  
BUDGET PROJECTIONS

	2017-18 PROJECTED	2018-19 PROJECTED	2019-20 PROJECTED	2020-21 PROJECTED	2021-22 PROJECTED
REVENUE SOURCE:					
TAXES	\$ -	\$ -	\$ -	\$ -	\$ -
LICENSES AND PERMITS	-	-	-	-	-
INTERGOVERN REVENUE	\$1,485,000	\$1,485,000	\$1,485,000	\$1,485,000	\$1,485,000
SERVICE CHARGES	-	-	-	-	-
FINES AND FORFEITS	-	-	-	-	-
MISCELLANEOUS	8,377	6,606	4,814	2,999	1,162
OTHER FINANCING	-	-	-	-	-
<b>TOTAL REVENUE</b>	<b>\$1,493,377</b>	<b>\$1,491,606</b>	<b>\$1,489,814</b>	<b>\$1,487,999</b>	<b>\$1,486,162</b>
EXPENSE OBJECT:					
PERSONNEL SERVICES	\$ -	\$ -	\$ -	\$ -	\$ -
MATERIALS & SUPPLIES	-	-	-	-	-
CONTRACTUAL SERVICES	-	-	-	-	-
GENERAL OPERATIONS	-	-	-	-	-
CAPITAL OUTLAY	-	-	-	-	-
SPECIAL PROJECTS	-	-	-	-	-
DEBT SERVICE	475,000	475,000	475,000	475,000	475,000
<b>TOTAL EXPENSES</b>	<b>\$ 475,000</b>	<b>\$ 475,000</b>	<b>\$ 475,000</b>	<b>\$ 475,000</b>	<b>\$ 475,000</b>
FUND TRANSFERS IN	-	-	-	-	-
FUND TRANSFERS OUT	1,160,000	1,160,000	1,160,000	1,160,000	1,160,000
PROJECTED REVENUE OVER(UNDER) BUDGET					
PROJECTED EXPENDITURES UNDER(OVER) BUDGET					
RESERVED FUND BALANCE DECREASE(INCREASE)					
EMERGENCY RESERVE FUND BALANCE DECREASE(INCREASE)					
BEGINNING UNRESERVED FUND BALANCE	745,133	603,510	460,116	314,930	167,929
ENDING UNRESERVED FUND BALANCE	<u>603,510</u>	<u>460,116</u>	<u>314,930</u>	<u>167,929</u>	<u>19,091</u>
EMERGENCY RESERVE FUND	<u>-</u>	<u>-</u>	<u>-</u>	<u>-</u>	<u>-</u>

MOTOR FUEL FUND REVENUE

	2013-14 <u>ACTUAL</u>	2014-15 <u>ACTUAL</u>	2015-16 <u>BUDGET</u>	2016-17 <u>PROPOSED</u>
DOT-Indirect Capital Grants	\$ 6,573	\$ 140,336	\$ -	\$ -
DOT-Indirect Capital Grants	135,278	(6)	-	-
Motor Fuel Tax	967,671	991,518	990,000	1,005,000
Motor Vehicle Sales Tax	283,880	304,273	295,000	315,000
Vehicle License Fees	<u>159,262</u>	<u>163,563</u>	<u>160,000</u>	<u>165,000</u>
	1,552,663	1,599,684	1,445,000	1,485,000
Interest on Overnight Investment:	7,821	10,544	6,250	5,000
Special Assessments	<u>3,244</u>	<u>2,754</u>	<u>2,637</u>	<u>-</u>
	11,064	13,298	8,887	5,000
Street Assessments	<u>4,287</u>	<u>4,578</u>	<u>4,468</u>	<u>-</u>
	4,287	4,578	4,468	-
Transfer fm TTF 1	<u>-</u>	<u>25,637</u>	<u>-</u>	<u>-</u>
	<u>\$1,568,014</u>	<u>\$1,643,197</u>	<u>\$1,458,355</u>	<u>\$1,490,000</u>

---

MOTOR FUEL

BUDGET BY MAJOR OBJECT

	2013-14 <u>ACTUAL</u>	2014-15 <u>ACTUAL</u>	2015-16 <u>BUDGET</u>	2016-17 <u>PROPOSED</u>
PERSONNEL COSTS	\$ -	\$ -	\$ -	\$ -
MATERIALS AND SUPPLIES	-	-	-	-
CONTRACTUAL SERVICES	-	-	-	-
GENERAL OPERATIONS	-	-	-	-
CAPITAL EXPENDITURES	365,118	273,665	-	-
SPECIAL PROJECTS	-	-	-	-
DEBT PAYMENTS	-	-	-	475,000
TRANSFERS	<u>970,000</u>	<u>1,120,000</u>	<u>1,420,000</u>	<u>1,445,000</u>
	<u>\$1,335,118</u>	<u>\$1,393,665</u>	<u>\$1,420,000</u>	<u>\$1,920,000</u>

---

THIS PAGE INTENTIONALLY LEFT BLANK

---

---

# **TRANSPORTATION SALES TAX TRUST FUND**



---

**TRANSPORTATION SALES TAX TRUST FUND**  
**BUDGET HIGHLIGHTS**

**ACTIVITIES**

The Transportation Sales Tax Trust Fund was a fund established to account for receipt of ½ cent sales tax authorized by the voters in August 1995, to fund major street improvement projects. The tax was effective January 1, 1996 through December 31, 2000.

**REVENUE/EXPENDITURE PROJECTIONS**

No revenues or expenditures are included in this budget. All projects were completed during the fiscal year ending June 30, 2005.

No future revenue and expenditure projections are made. This fund was closed during the previous fiscal year.

TRANSPORTATION SALES TAX TRUST FUND  
BUDGET BY MAJOR OBJECT

	<u>2013-14</u> <u>ACTUAL</u>	<u>2014-15</u> <u>ACTUAL</u>	<u>2015-16</u> <u>BUDGET</u>	<u>2016-17</u> <u>BUDGET</u>
REVENUE SOURCE:				
TAXES	\$ -	\$ -	\$ -	\$ -
LICENSES AND PERMITS	-	-	-	-
INTERGOVERN REVENUE	-	-	-	-
SERVICE CHARGES	-	-	-	-
FINES AND FORFEITS	-	-	-	-
MISCELLANEOUS	837	50	-	-
OTHER FINANCING	<u>12,618</u>	<u>-</u>	<u>-</u>	<u>-</u>
TOTAL REVENUE	\$13,455	\$50	\$ -	\$ -
EXPENSE OBJECT:				
PERSONNEL SERVICES	\$ -	\$ -	\$ -	\$ -
MATERIALS & SUPPLIES	-	-	-	-
CONTRACTUAL SERVICES	-	-	-	-
GENERAL OPERATIONS	-	-	-	-
CAPITAL OUTLAY	-	-	-	-
SPECIAL PROJECTS	-	-	-	-
DEBT SERVICE	<u>-</u>	<u>-</u>	<u>-</u>	<u>-</u>
TOTAL EXPENSES	<u>\$ -</u>	<u>\$ -</u>	<u>\$ -</u>	<u>\$ -</u>
FUND TRANSFERS IN	-	-	-	-
FUND TRANSFERS OUT	-	25,637	-	-
PROJECTED REVENUE				
OVER(UNDER) BUDGET			3,374	
PROJECTED EXPENDITURES				
UNDER(OVER) BUDGET			(3,374)	
RESERVED FUND BALANCE				
DECREASE(INCREASE)				
EMERGENCY RESERVE FUND BALANCE				
DECREASE(INCREASE)				-
BEGINNING UNRESERVED FUND				
BALANCE			-	-
ENDING UNRESERVED FUND				
BALANCE			<u>-</u>	<u>-</u>
EMERGENCY RESERVE FUND			<u>-</u>	<u>-</u>

TRANSPORTATION SALES TAX TRUST FUND

	2013-14 ACTUAL	2014-15 ACTUAL	2015-16 BUDGET	2016-17 PROPOSED
Interest on Overnight Investment: \$	225	\$ -	\$ -	\$ -
Special Assessments	<u>612</u>	<u>50</u>	<u>-</u>	<u>-</u>
	837	50	-	-
Street Assessments	<u>12,618</u>	<u>0</u>	<u>-</u>	<u>-</u>
	12,618	0	-	-
	<u>\$13,455</u>	<u>\$50</u>	<u>\$ -</u>	<u>\$ -</u>

---

TRANSPORTATION SALES TAX TRUST FUND

BUDGET BY MAJOR OBJECT

	2013-14 <u>ACTUAL</u>	2014-15 <u>ACTUAL</u>	2015-16 <u>BUDGET</u>	2016-17 <u>PROPOSED</u>
PERSONNEL COSTS	\$ -	\$ -	\$ -	\$ -
MATERIALS AND SUPPLIES	-	-	-	-
CONTRACTUAL SERVICES	-	-	-	-
GENERAL OPERATIONS	-	-	-	-
CAPITAL EXPENDITURES	-	-	-	-
SPECIAL PROJECTS	-	-	-	-
DEBT PAYMENTS	-	-	-	-
TRANSFERS	-	25,637	-	-
	<u>\$ -</u>	<u>\$ 25,637</u>	<u>\$ -</u>	<u>\$ -</u>

---

THIS PAGE INTENTIONALLY LEFT BLANK

---

---

**TRANSPORTATION  
SALES  
TAX  
TRUST  
FUND  
II**

---

**TRANSPORTATION SALES TAX TRUST FUND II**  
**BUDGET HIGHLIGHTS**

**ACTIVITIES**

The Transportation Sales Tax Trust Fund II was a fund established to account for receipt of ½ cent sales tax authorized by the voters in August 2000, to fund major street improvement projects. The tax was effective January 1, 2001 through December 31, 2005.

**REVENUE/EXPENDITURE PROJECTIONS**

No revenues or expenditures are included in this budget. All the projects originally anticipated to be completed by the tax were completed by the fiscal year ending June 30, 2010.

No future revenue and expenditure projections are made. This fund was closed during the previous fiscal year.

TRANSPORTATION SALES TAX TRUST FUND II  
BUDGET BY MAJOR OBJECT

	<u>2013-14</u> <u>ACTUAL</u>	<u>2014-15</u> <u>ACTUAL</u>	<u>2015-16</u> <u>BUDGET</u>	<u>2016-17</u> <u>BUDGET</u>
REVENUE SOURCE:				
TAXES	\$ -	\$ -	\$ -	\$ -
LICENSES AND PERMITS	-	-	-	-
INTERGOVERN REVENUE	-	-	-	-
SERVICE CHARGES	-	-	-	-
FINES AND FORFEITS	-	-	-	-
MISCELLANEOUS	1,123	-	-	-
OTHER FINANCING	<u>20,078</u>	<u>-</u>	<u>-</u>	<u>-</u>
TOTAL REVENUE	\$ 21,201	\$ -	\$ -	\$ -
EXPENSE OBJECT:				
PERSONNEL SERVICES	\$ -	\$ -	\$ -	\$ -
MATERIALS & SUPPLIES	-	-	-	-
CONTRACTUAL SERVICES	-	-	-	-
GENERAL OPERATIONS	-	-	-	-
CAPITAL OUTLAY	-	-	-	-
SPECIAL PROJECTS	-	-	-	-
DEBT SERVICE	<u>-</u>	<u>-</u>	<u>-</u>	<u>-</u>
TOTAL EXPENSES	<u>\$ -</u>	<u>\$ -</u>	<u>\$ -</u>	<u>\$ -</u>
FUND TRANSFERS IN	-	-	-	-
FUND TRANSFERS OUT	25,000	1,562	-	-
PROJECTED REVENUE				
OVER(UNDER) BUDGET			-	
PROJECTED EXPENDITURES				
UNDER(OVER) BUDGET			-	
RESERVED FUND BALANCE				
DECREASE(INCREASE)				
EMERGENCY RESERVE FUND BALANCE				
DECREASE(INCREASE)				
BEGINNING UNRESERVED FUND				
BALANCE			-	-
ENDING UNRESERVED FUND				
BALANCE			<u>-</u>	<u>-</u>
EMERGENCY RESERVE FUND			<u>-</u>	<u>-</u>



TRANSPORTATION SALES TAX TRUST FUND II

	2013-14 ACTUAL	2014-15 ACTUAL	2015-16 BUDGET	2016-17 PROPOSED
Interest on Overnight Investment: \$	233	\$ -	\$ -	\$ -
Special Assessments	<u>890</u>	<u>-</u>	<u>-</u>	<u>-</u>
	1,123	-	-	-
Street Assessments	<u>20,078</u>	<u>-</u>	<u>-</u>	<u>-</u>
	20,078	-	-	-
	<u>\$ 21,201</u>	<u>\$ -</u>	<u>\$ -</u>	<u>\$ -</u>

---

TRANSPORTATION SALES TAX II

BUDGET BY MAJOR OBJECT

	2013-14 <u>ACTUAL</u>	2014-15 <u>ACTUAL</u>	2015-16 <u>BUDGET</u>	2016-17 <u>PROPOSED</u>
PERSONNEL COSTS	\$ -	\$ -	\$ -	\$ -
MATERIALS AND SUPPLIES	-	-	-	-
CONTRACTUAL SERVICES	-	-	-	-
GENERAL OPERATIONS	-	-	-	-
CAPITAL EXPENDITURES	-	-	-	-
SPECIAL PROJECTS	-	-	-	-
DEBT PAYMENTS	-	-	-	-
TRANSFERS	<u>25,000</u>	<u>1,562</u>	<u>-</u>	<u>-</u>
	<u>\$ 25,000</u>	<u>\$ 1,562</u>	<u>\$ -</u>	<u>\$ -</u>

---

THIS PAGE INTENTIONALLY LEFT BLANK

---

---

**TRANSPORTATION  
SALES  
TAX  
TRUST  
FUND  
III**

---

## **TRANSPORTATION SALES TAX TRUST FUND III** **BUDGET HIGHLIGHTS**

### **ACTIVITIES**

The Transportation Sales Tax Trust Fund was a fund established to account for receipt of ½ cent sales tax authorized by the voters in August 2005, to fund major street improvement projects. The tax was effective January 1, 2006 through December 31, 2010.

### **REVENUE/EXPENDITURE PROJECTIONS**

No revenues are projected for the fiscal year ending June 30, 2017. This budget includes \$2,000,000 for improvements to neighborhood streets.

During the current year funds that were originally planned for an Armstrong Drive project were reallocated to be spent on repairing neighborhood streets. The Armstrong Drive project was determined to be no longer feasible because of higher than expected right-of-way acquisition costs.

The amount included in this budget along with anticipated current year's expenditures appropriated during the year should complete the expenditure of the remaining balances of this fund.

TRANSPORTATION SALES TAX TRUST FUND III  
BUDGET BY MAJOR OBJECT

	2013-14 <u>ACTUAL</u>	2014-15 <u>ACTUAL</u>	2015-16 <u>BUDGET</u>	2016-17 <u>BUDGET</u>
REVENUE SOURCE:				
TAXES	\$ -	\$ -	\$ -	\$ -
LICENSES AND PERMITS	-	-	-	-
INTERGOVERN REVENUE	-	-	-	-
SERVICE CHARGES	-	-	-	-
FINES AND FORFEITS	-	-	-	-
MISCELLANEOUS	39,332	42,391	-	-
OTHER FINANCING	-	-	-	-
	<hr/>	<hr/>	<hr/>	<hr/>
TOTAL REVENUE	\$39,332	\$42,391	\$ -	\$ -
EXPENSE OBJECT:				
PERSONNEL SERVICES	\$ -	\$ -	\$ -	\$ -
MATERIALS & SUPPLIES	-	-	-	-
CONTRACTUAL SERVICES	-	-	-	-
GENERAL OPERATIONS	-	-	-	-
CAPITAL OUTLAY	53,209	1,930	-	2,000,000
SPECIAL PROJECTS	-	-	-	-
DEBT SERVICE	-	-	-	-
	<hr/>	<hr/>	<hr/>	<hr/>
TOTAL EXPENSES	\$53,209	\$1,930	\$ -	\$ 2,000,000
FUND TRANSFERS IN	25,000	1,562	-	-
FUND TRANSFERS OUT	-	-	-	-
PROJECTED REVENUE				
OVER(UNDER) BUDGET			40,000	
PROJECTED EXPENDITURES				
UNDER(OVER) BUDGET			(1,288,070)	
RESERVED FUND BALANCE				
DECREASE(INCREASE)				
EMERGENCY RESERVE FUND BALANCE				
DECREASE(INCREASE)				
BEGINNING UNRESERVED FUND				
BALANCE			3,248,070	2,000,000
ENDING UNRESERVED FUND				
BALANCE			<hr/> <u>2,000,000</u>	<hr/> <u>-</u>
EMERGENCY RESERVE FUND			<hr/> <u>-</u>	<hr/> <u>-</u>

TRANSPORTATION SALES TAX TRUST FUND III

	2013-14 ACTUAL	2014-15 ACTUAL	2015-16 BUDGET	2016-17 PROPOSED
Interest on Overnight Investments	<u>\$ 39,332</u>	<u>\$ 42,391</u>	<u>\$ -</u>	<u>\$ -</u>
	39,332	42,391	-	-
Transfers In - TTF II	<u>25,000</u>	<u>1,562</u>	<u>-</u>	<u>-</u>
	25,000	1,562	-	-
	<u><u>\$ 64,332</u></u>	<u><u>\$ 43,953</u></u>	<u><u>\$ -</u></u>	<u><u>\$ -</u></u>

---

TRANSPORTATION SALES TAX TRUST FUND III

BUDGET BY MAJOR OBJECT

	2013-14 <u>ACTUAL</u>	2014-15 <u>ACTUAL</u>	2015-16 <u>BUDGET</u>	2016-17 <u>PROPOSED</u>
PERSONNEL COSTS	\$ -	\$ -	\$ -	-
MATERIALS AND SUPPLIES	-	-	-	-
CONTRACTUAL SERVICES	-	-	-	-
GENERAL OPERATIONS	-	-	-	-
CAPITAL EXPENDITURES	53,209	1,930	-	2,000,000
SPECIAL PROJECTS	-	-	-	-
DEBT PAYMENTS	-	-	-	-
TRANSFERS	-	-	-	-
	<u>\$ 53,209</u>	<u>\$ 1,930</u>	<u>\$ -</u>	<u>2,000,000</u>



---

THIS PAGE INTENTIONALLY LEFT BLANK

---

---

**TRANSPORTATION  
SALES  
TAX  
TRUST  
FUND  
IV**

---

**TRANSPORTATION SALES TAX TRUST FUND IV**  
**BUDGET HIGHLIGHTS**

**ACTIVITIES**

The Transportation Sales Tax Trust Fund was a fund established to account for receipt of ½ cent sales tax authorized by the voters in August 2010, to fund major street improvement projects. The tax was effective January 1, 2011 through December 31, 2015.

**REVENUE/EXPENDITURE PROJECTIONS**

\$25,000 of interest earnings on unused cash balances is projected for this budget. Capital outlays included in this budget represent amounts available to complete all remaining projects with the exception of Mustang Drive. Completion of this project will be decided by the City Council in the future.

**TRANSPORTATION SALES TAX TRUST FUND IV  
2016-2017 RESOURCES**

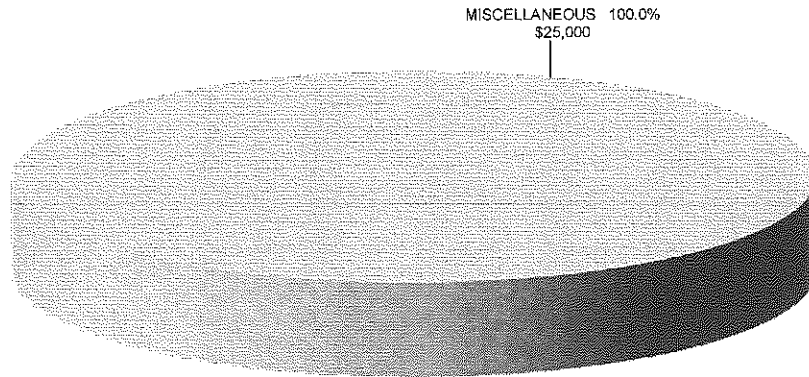

**TRANSPORTATION SALES TAX TRUST FUND IV  
2016-2017 EXPENDITURES**

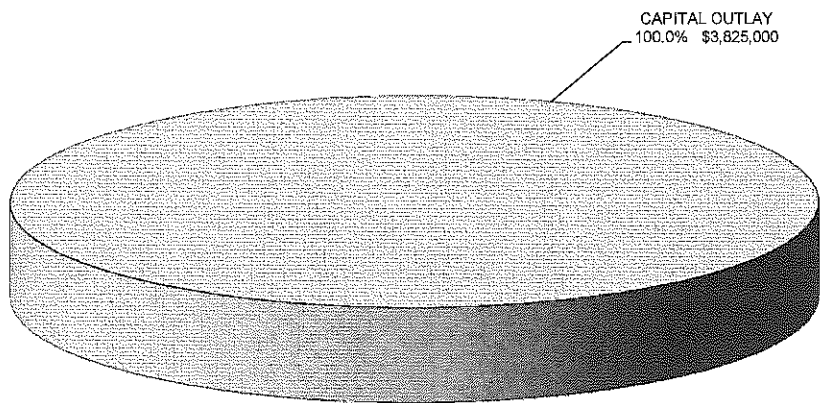

TRANSPORTATION SALES TAX TRUST FUND IV  
BUDGET BY MAJOR OBJECT

	<u>2013-14</u> <u>ACTUAL</u>	<u>2014-15</u> <u>ACTUAL</u>	<u>2015-16</u> <u>BUDGET</u>	<u>2016-17</u> <u>BUDGET</u>
REVENUE SOURCE:				
TAXES	\$4,736,235	\$ 4,919,236	\$ 3,100,000	\$ -
LICENSES AND PERMITS	-	-	-	-
INTERGOVERN REVENUE	30,000	30,000	-	-
SERVICE CHARGES	-	-	-	-
FINES AND FORFEITS	-	-	-	-
MISCELLANEOUS	39,179	87,798	25,000	25,000
OTHER FINANCING	-	-	-	-
	<hr/>	<hr/>	<hr/>	<hr/>
TOTAL REVENUE	\$4,805,414	\$ 5,037,034	\$ 3,125,000	\$25,000
EXPENSE OBJECT:				
PERSONNEL SERVICES	\$ -	\$ -	\$ -	\$ -
MATERIALS & SUPPLIES	-	-	-	-
CONTRACTUAL SERVICES	-	-	-	-
GENERAL OPERATIONS	-	-	-	-
CAPITAL OUTLAY	721,715	3,518,928	5,177,500	3,825,000
SPECIAL PROJECTS	220,131	277,433	235,000	-
DEBT SERVICE	-	-	-	-
	<hr/>	<hr/>	<hr/>	<hr/>
TOTAL EXPENSES	\$ 941,846	\$ 3,796,361	\$ 5,412,500	\$ 3,825,000
FUND TRANSFERS IN	260,000	260,000	-	-
FUND TRANSFERS OUT	-	-	-	-
PROJECTED REVENUE				
OVER(UNDER) BUDGET			140,000	
PROJECTED EXPENDITURES				
UNDER(OVER) BUDGET			(394,062)	
RESERVED FUND BALANCE				
DECREASE(INCREASE)				
EMERGENCY RESERVE FUND BALANCE				
DECREASE(INCREASE)				
BEGINNING UNRESERVED FUND				
BALANCE			6,611,562	4,070,000
ENDING UNRESERVED FUND				
BALANCE			<u>4,070,000</u>	<u>270,000</u>
EMERGENCY RESERVE FUND			<u>-</u>	<u>-</u>

TRANSPORTATION SALES TAX TRUST FUND IV  
BUDGET PROJECTIONS

	<u>2017-18</u> <u>PROJECTED</u>	<u>2018-19</u> <u>PROJECTED</u>	<u>2019-20</u> <u>PROJECTED</u>	<u>2020-21</u> <u>PROJECTED</u>	<u>2021-22</u> <u>PROJECTED</u>
REVENUE SOURCE:					
TAXES	\$5,280,203	\$ 5,385,807	\$ 5,493,523	\$ 3,419,191	\$ -
LICENSES AND PERMITS	-	-	-	-	-
INTERGOVERN REVENUE	-	-	-	-	-
SERVICE CHARGES	-	-	-	-	-
FINES AND FORFEITS	-	-	-	-	-
MISCELLANEOUS	16,772	4,154	28,575	54,501	58,717
OTHER FINANCING	-	-	-	-	-
<b>TOTAL REVENUE</b>	<u>\$5,296,975</u>	<u>\$ 5,389,961</u>	<u>\$ 5,522,098</u>	<u>\$ 3,473,692</u>	<u>\$ 58,717</u>
EXPENSE OBJECT:					
PERSONNEL SERVICES	\$ -	\$ -	\$ -	\$ -	\$ -
MATERIALS & SUPPLIES	-	-	-	-	-
CONTRACTUAL SERVICES	-	-	-	-	-
GENERAL OPERATIONS	-	-	-	-	-
CAPITAL OUTLAY	7,415,000	4,715,000	1,665,000	2,665,000	-
SPECIAL PROJECTS	291,312	297,138	303,081	188,639	-
DEBT SERVICE	-	-	-	-	-
<b>TOTAL EXPENSES</b>	<u>\$7,706,312</u>	<u>\$ 5,012,138</u>	<u>\$ 1,968,081</u>	<u>\$ 2,853,639</u>	<u>\$ -</u>
FUND TRANSFERS IN	-	-	-	-	-
FUND TRANSFERS OUT	-	-	-	-	-
PROJECTED REVENUE OVER(UNDER) BUDGET					
PROJECTED EXPENDITURES UNDER(OVER) BUDGET					
RESERVED FUND BALANCE DECREASE(INCREASE)					
EMERGENCY RESERVE FUND BALANCE DECREASE(INCREASE)					
BEGINNING UNRESERVED FUND BALANCE	2,554,820	145,483	523,306	4,077,323	4,697,376
ENDING UNRESERVED FUND BALANCE	<u>145,483</u>	<u>523,306</u>	<u>4,077,323</u>	<u>4,697,376</u>	<u>4,756,093</u>
EMERGENCY RESERVE FUND	<u>-</u>	<u>-</u>	<u>-</u>	<u>-</u>	<u>-</u>

TRANSPORTATION SALES TAX TRUST FUND IV

	2013-14 ACTUAL	2014-15 ACTUAL	2015-16 BUDGET	2016-17 PROPOSED
Transportation Sales Tax	<u>\$4,736,235</u>	<u>\$4,919,236</u>	<u>\$3,100,000</u>	<u>-</u>
	4,736,235	4,919,236	3,100,000	-
Miscellaneous Local Grants	<u>30,000</u>	<u>30,000</u>	<u>-</u>	<u>-</u>
	30,000	30,000	-	-
Interest on Overnight Investments	<u>39,179</u>	<u>87,798</u>	<u>25,000</u>	<u>25,000</u>
	39,179	87,798	25,000	25,000
Transfers in Casino Revenue Fund	<u>260,000</u>	<u>260,000</u>	<u>-</u>	<u>-</u>
	260,000	260,000	-	-
	<u>\$5,065,414</u>	<u>\$5,297,034</u>	<u>\$3,125,000</u>	<u>\$ 25,000</u>

---

TRANSPORTATION SALES TAX TRUST FUND IV

BUDGET BY MAJOR OBJECT

	2013-14 <u>ACTUAL</u>	2014-15 <u>ACTUAL</u>	2015-16 <u>BUDGET</u>	2016-17 <u>PROPOSED</u>
PERSONNEL COSTS	\$ -	\$ -	\$ -	\$ -
MATERIALS AND SUPPLIES	-	-	-	-
CONTRACTUAL SERVICES	-	-	-	-
GENERAL OPERATIONS	-	-	-	-
CAPITAL EXPENDITURES	721,715	3,518,928	5,177,500	3,825,000
SPECIAL PROJECTS	220,131	277,433	235,000	-
DEBT PAYMENTS	-	-	-	-
TRANSFERS	-	-	-	-
	<u>\$ 941,846</u>	<u>\$3,796,361</u>	<u>\$5,412,500</u>	<u>\$3,825,000</u>



---

THIS PAGE INTENTIONALLY LEFT BLANK

---

---

**TRANSPORTATION  
SALES  
TAX  
TRUST  
FUND  
V**

---

## **TRANSPORTATION SALES TAX TRUST FUND V** **BUDGET HIGHLIGHTS**

### **ACTIVITIES**

The Transportation Sales Tax Trust Fund is a fund established to account for receipt of ½ cent sales tax authorized by the voters in August 2015, to fund major street improvement projects. The tax is effective January 1, 2016 through December 31, 2020.

### **REVENUE/EXPENDITURE PROJECTIONS**

Sales tax for the fiscal year ending June 30, 2017 is projected to be 5.2% above the actual sales tax for fiscal year ending June 30, 2015 and projected to increase 2% per year thereafter through the expiration of the tax. All projected revenue will be used to make required payments under various development agreements and for capital expenditures that are identified in the City's CIP program.

**TRANSPORTATION SALES TAX TRUST FUND V  
2016-2017 RESOURCES**

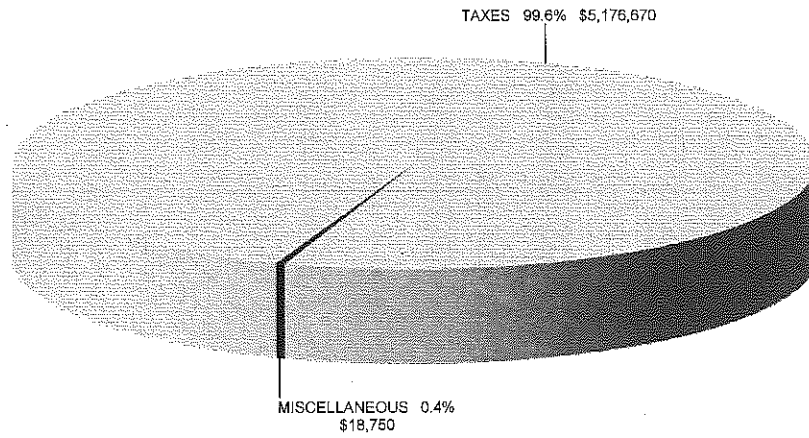

**TRANSPORTATION SALES TAX TRUST FUND V  
2016-2017 EXPENDITURES**

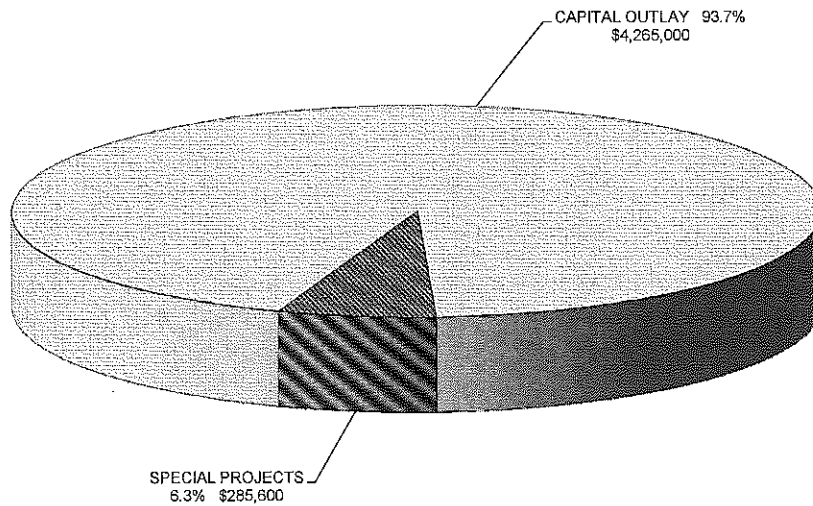

TRANSPORTATION SALES TAX TRUST FUND V  
BUDGET BY MAJOR OBJECT

	<u>2013-14</u> <u>ACTUAL</u>	<u>2014-15</u> <u>ACTUAL</u>	<u>2015-16</u> <u>BUDGET</u>	<u>2016-17</u> <u>BUDGET</u>
REVENUE SOURCE:				
TAXES	-	-	-	\$ 5,176,670
LICENSES AND PERMITS	-	-	-	-
INTERGOVERN REVENUE	-	-	-	-
SERVICE CHARGES	-	-	-	-
FINES AND FORFEITS	-	-	-	-
MISCELLANEOUS	-	-	-	18,750
OTHER FINANCING	-	-	-	-
	<hr/>	<hr/>	<hr/>	<hr/>
TOTAL REVENUE	\$ -	\$ -	\$ -	\$5,195,420
EXPENSE OBJECT:				
PERSONNEL SERVICES	\$ -	\$ -	\$ -	\$ -
MATERIALS & SUPPLIES	-	-	-	-
CONTRACTUAL SERVICES	-	-	-	-
GENERAL OPERATIONS	-	-	-	-
CAPITAL OUTLAY	-	-	-	4,265,000
SPECIAL PROJECTS	-	-	-	285,600
DEBT SERVICE	-	-	-	-
	<hr/>	<hr/>	<hr/>	<hr/>
TOTAL EXPENSES	\$ -	\$ -	\$ -	\$ 4,550,600
FUND TRANSFERS IN	-	-	-	-
FUND TRANSFERS OUT	-	-	-	-
PROJECTED REVENUE				
OVER(UNDER) BUDGET			1,910,000	
PROJECTED EXPENDITURES				
UNDER(OVER) BUDGET				
RESERVED FUND BALANCE				
DECREASE(INCREASE)				
EMERGENCY RESERVE FUND BALANCE				
DECREASE(INCREASE)				
BEGINNING UNRESERVED FUND				
BALANCE			-	1,910,000
ENDING UNRESERVED FUND				
BALANCE			<u>1,910,000</u>	<u>2,554,820</u>
EMERGENCY RESERVE FUND			<u>-</u>	<u>-</u>

TRANSPORTATION SALES TAX TRUST FUND V

	2013-14 ACTUAL	2014-15 ACTUAL	2015-16 BUDGET	2016-17 PROPOSED
Transportation Sales Tax	\$ -	\$ -	\$ -	5,176,670
	-	-	-	5,176,670
Interest on Overnight Investments	-	-	-	18,750
	-	-	-	18,750
	<u>\$ -</u>	<u>\$ -</u>	<u>\$ -</u>	<u>\$5,195,420</u>

---

TRANSPORTATION SALES TAX TRUST FUND V

BUDGET BY MAJOR OBJECT

	2013-14 <u>ACTUAL</u>	2014-15 <u>ACTUAL</u>	2015-16 <u>BUDGET</u>	2016-17 <u>PROPOSED</u>
PERSONNEL COSTS	\$ -	\$ -	\$ -	\$ -
MATERIALS AND SUPPLIES	-	-	-	-
CONTRACTUAL SERVICES	-	-	-	-
GENERAL OPERATIONS	-	-	-	-
CAPITAL EXPENDITURES	-	-	-	4,265,000
SPECIAL PROJECTS	-	-	-	285,600
DEBT PAYMENTS	-	-	-	-
TRANSFERS	-	-	-	-
	<u>\$ -</u>	<u>\$ -</u>	<u>\$ -</u>	<u>\$4,550,600</u>

---

**CAPITAL  
IMPROVEMENT  
SALES  
TAX  
FUND**

**WATER  
PROJECTS**



---

**CAPITAL IMPROVEMENT SALES TAX FUND-WATER PROJECTS**  
**BUDGET HIGHLIGHTS**

**ACTIVITIES**

The Capital Improvement Sales Tax Fund is a fund established to account for receipt of ¼¢ sales tax collections authorized by the voters in November, 1996, to fund major capital improvement projects to the city's water system. The tax approved will expire March 31, 2017.

Included in this budget is debt service on 2010 water system revenue bonds, \$122,125 in payments on the Sears Grand's, Kohl's, and Greater Missouri Builder's development agreements, and \$2,325,300 in transfers to the water fund. These transfers will be used to fund water system improvements.

**REVENUE/EXPENDITURE PROJECTIONS**

Sales tax for the fiscal year ending June 30, 2017 is projected through the expiration of the tax at 2% above current year's projected revenue. Projected expenditures are annual debt service on the 2010 water system revenue bonds.

**CAPITAL IMP. SALES TAX FUND - WATER PROJECTS  
2016-2017 RESOURCES**

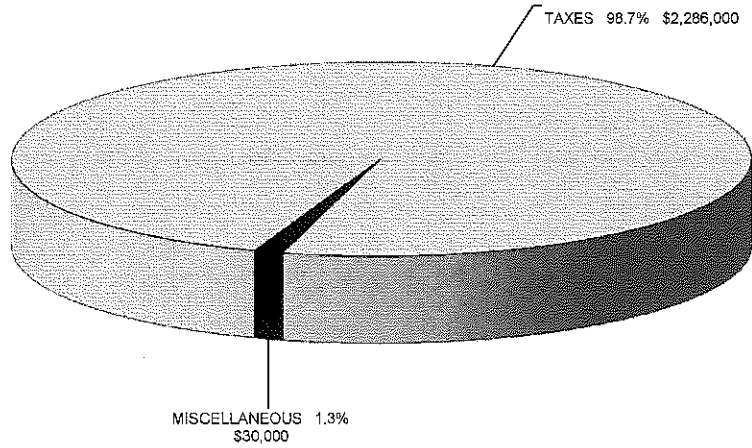

**CAPITAL IMP. SALES TAX FUND - WATER PROJECTS  
2015-2016 EXPENDITURES**

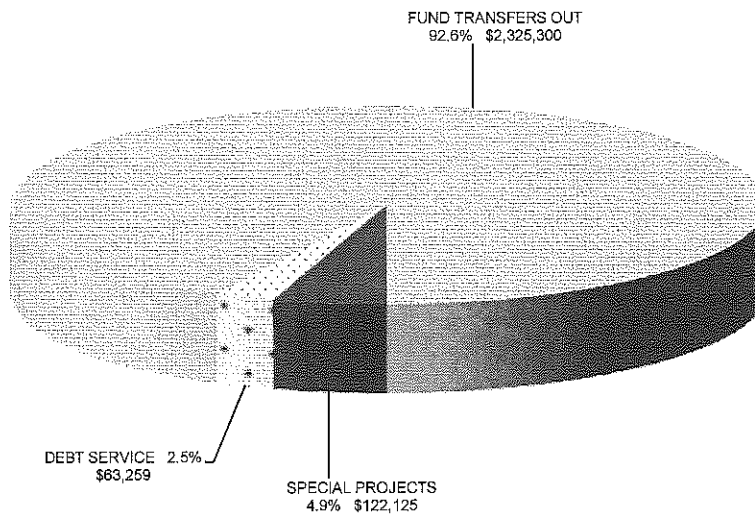

CAPITAL IMPROVEMENT SALES TAX FUND  
(WATER PROJECTS)  
BUDGET BY MAJOR OBJECT

	2013-14 <u>ACTUAL</u>	2014-15 <u>ACTUAL</u>	2015-16 <u>BUDGET</u>	2016-17 <u>BUDGET</u>
REVENUE SOURCE:				
TAXES	\$2,448,927	\$2,538,305	\$2,606,250	\$2,286,000
LICENSES AND PERMITS	-	-	-	-
INTERGOVERN REVENUE	-	-	-	-
SERVICE CHARGES	-	-	-	-
FINES AND FORFEITS	-	-	-	-
MISCELLANEOUS	53,315	77,217	60,000	30,000
OTHER FINANCING	-	-	-	-
	<hr/>	<hr/>	<hr/>	<hr/>
TOTAL REVENUE	\$2,502,242	\$2,615,522	\$2,666,250	\$2,316,000
EXPENSE OBJECT:				
PERSONNEL SERVICES	\$ -	\$ -	\$ -	\$ -
MATERIALS & SUPPLIES	-	-	-	-
CONTRACTUAL SERVICES	-	-	-	-
GENERAL OPERATIONS	-	-	-	-
CAPITAL OUTLAY	-	-	-	-
SPECIAL PROJECTS	114,336	140,251	130,000	122,125
DEBT SERVICE	59,756	62,511	62,845	63,259
	<hr/>	<hr/>	<hr/>	<hr/>
TOTAL EXPENSES	\$ 174,091	\$ 202,763	\$ 192,845	\$ 185,384
FUND TRANSFERS IN	-	-	-	-
FUND TRANSFERS OUT	40,500	3,140,881	6,649,500	2,325,300
PROJECTED REVENUE				
OVER(UNDER) BUDGET			25,220	
PROJECTED EXPENDITURES				
UNDER(OVER) BUDGET			842,010	
RESERVED FUND BALANCE				
DECREASE(INCREASE)				
EMERGENCY RESERVE FUND BALANCE				
DECREASE(INCREASE)				1,119
BEGINNING UNRESERVED FUND				
BALANCE			4,931,681	1,622,816
ENDING UNRESERVED FUND				
BALANCE			<u>1,622,816</u>	<u>1,429,251</u>
EMERGENCY RESERVE FUND			<u>28,927</u>	<u>27,808</u>

CAPITAL IMPROVEMENT SALES TAX FUND  
(WATER PROJECTS)  
BUDGET PROJECTIONS

	<u>2017-2018</u> <u>PROJECTED</u>	<u>2018-2019</u> <u>PROJECTED</u>	<u>2019-2020</u> <u>PROJECTED</u>	<u>2020-2021</u> <u>PROJECTED</u>	<u>2021-2022</u> <u>PROJECTED</u>
REVENUE SOURCE:					
TAXES	\$ -	\$ -	\$ -	\$ -	\$ -
LICENSES AND PERMITS	-	-	-	-	-
INTERGOVERN REVENUE	-	-	-	-	-
SERVICE CHARGES	-	-	-	-	-
FINES AND FORFEITS	-	-	-	-	-
MISCELLANEOUS	17,815	17,241	16,654	16,055	15,445
OTHER FINANCING	-	-	-	-	-
	<u>-</u>	<u>-</u>	<u>-</u>	<u>-</u>	<u>-</u>
TOTAL REVENUE	\$17,815	\$17,241	\$16,654	\$16,055	\$15,445
EXPENSE OBJECT:					
PERSONNEL SERVICES	\$ -	\$ -	\$ -	\$ -	\$ -
MATERIALS & SUPPLIES	-	-	-	-	-
CONTRACTUAL SERVICES	-	-	-	-	-
GENERAL OPERATIONS	-	-	-	-	-
CAPITAL OUTLAY	-	-	-	-	-
SPECIAL PROJECTS	-	-	-	-	-
DEBT SERVICE	63,658	63,940	64,408	64,658	65,092
	<u>63,658</u>	<u>63,940</u>	<u>64,408</u>	<u>64,658</u>	<u>65,092</u>
TOTAL EXPENSES	\$63,658	\$63,940	\$64,408	\$64,658	\$65,092
FUND TRANSFERS IN	-	-	-	-	-
FUND TRANSFERS OUT	-	-	-	-	-
PROJECTED REVENUE OVER(UNDER) BUDGET					
PROJECTED EXPENDITURES UNDER(OVER) BUDGET					
RESERVED FUND BALANCE DECREASE(INCREASE)					
EMERGENCY RESERVE FUND BALANCE DECREASE(INCREASE)	18,259	(42)	(70)	(38)	(65)
BEGINNING UNRESERVED FUND BALANCE	1,429,251	1,401,667	1,354,926	1,307,102	1,258,461
ENDING UNRESERVED FUND BALANCE	<u>1,401,667</u>	<u>1,354,926</u>	<u>1,307,102</u>	<u>1,258,461</u>	<u>1,208,749</u>
EMERGENCY RESERVE FUND	<u>9,549</u>	<u>9,591</u>	<u>9,661</u>	<u>9,699</u>	<u>9,764</u>

CAPITAL IMPROVEMENT SALES TAX REVENUE  
(WATER PROJECTS)

	2013-14 <u>ACTUAL</u>	2014-15 <u>ACTUAL</u>	2015-16 <u>BUDGET</u>	2016-17 <u>PROPOSED</u>
Capital Improvemts Sales Tax	<u>2,448,927</u>	<u>2,538,305</u>	<u>2,606,250</u>	<u>2,286,000</u>
	2,448,927	2,538,305	2,606,250	2,286,000
Interest on Overnight Invmts	53,311	77,213	60,000	30,000
Interest on SRF Investments	<u>4</u>	<u>4</u>	<u>-</u>	<u>-</u>
	53,315	77,217	60,000	30,000
Transfer from Water Proj Fd	<u>-</u>	<u>36</u>	<u>-</u>	<u>-</u>
	-	36	-	-
	<u>\$2,502,242</u>	<u>\$2,615,558</u>	<u>\$2,666,250</u>	<u>\$2,316,000</u>

CAPITAL IMPROVEMENT SALES TAX  
(WATER PROJECTS)  
BUDGET BY MAJOR OBJECT

	2013-14 <u>ACTUAL</u>	2014-15 <u>ACTUAL</u>	2015-16 <u>BUDGET</u>	2016-17 <u>PROPOSED</u>
PERSONNEL COSTS	\$ -	\$ -	\$ -	\$ -
MATERIALS AND SUPPLIES	-	-	-	-
CONTRACTUAL SERVICES	-	-	-	-
GENERAL OPERATIONS	-	-	-	-
CAPITAL EXPENDITURES	-	-	-	-
SPECIAL PROJECTS	114,336	140,251	130,000	122,125
DEBT PAYMENTS	59,756	62,511	62,845	63,259
TRANSFERS	40,500	3,140,881	6,649,500	2,325,300
	<u>\$214,591</u>	<u>\$3,343,644</u>	<u>\$6,842,345</u>	<u>\$2,510,684</u>

---

THIS PAGE INTENTIONALLY LEFT BLANK

---

---

**CAPITAL  
IMPROVEMENT  
SALES  
TAX  
FUND**

**SEWER SYSTEM  
IMPROVEMENTS**



---

**CAPITAL IMPROVEMENT SALES TAX FUND-SEWER SYSTEM IMPRV.**  
**BUDGET HIGHLIGHTS**

**ACTIVITIES**

The Capital Improvement Sales Tax Fund – Sewer System Improvements is a fund established to account for receipt of ¼¢ sales tax collections authorized by the voters for improvements to the city's sewer system. This tax was initially authorized by voters in November, 1988, to fund major capital improvement projects for flood control and subsequently extended by the voters for twenty years to pay for improvements to the city's sewer system. The extension of the tax will be reported in this fund through its December 31, 2019 expiration.

A ¼¢ sales tax that was initially authorized by voters to fund major capital improvement projects for the water system which was set to expire March 31, 2017 was subsequently extended by the voters for twenty years to pay for improvements to the city's sewer system. The extension of this tax will be also be reported in this fund.

Included in this budget are sales tax and interest revenue, payments on the Sears Grand's, Kohl's, and Greater Missouri Builder's development agreements, and transfers to the sewer fund for debt service on bonds issued to build the new sewer plant.

**REVENUE/EXPENDITURE PROJECTIONS**

Sales tax for the fiscal year ending June 30, 2017 is projected to include a share of the additional ¼% capital improvement sales. Both taxes are projected to be 5.3% above the actual sales tax for fiscal year ending June 30, 2015 and projected to increase 2% per year thereafter through their respective expiration dates. Future fund revenue will be transferred to the Sewer Fund as needed for capital and debt service expenditures and to make payments required by development agreements. No capital outlays are reflected during the entire 6-year period.

CAPITAL IMPROVEMENT SALES TAX FUND  
(SEWER SYSTEM IMPROVEMENTS)  
BUDGET BY MAJOR OBJECT

	2013-14 <u>ACTUAL</u>	2014-15 <u>ACTUAL</u>	2015-16 <u>BUDGET</u>	2016-17 <u>BUDGET</u>
REVENUE SOURCE:				
TAXES	\$2,448,930	\$2,538,309	\$2,606,250	\$3,061,800
LICENSES AND PERMITS	-	-	-	-
INTERGOVERN REVENUE	-	-	-	-
SERVICE CHARGES	-	-	-	-
FINES AND FORFEITS	-	-	-	-
MISCELLANEOUS	29,122	42,257	25,000	30,000
OTHER FINANCING	-	-	-	-
	<hr/>	<hr/>	<hr/>	<hr/>
TOTAL REVENUE	\$2,478,052	\$2,580,566	\$2,631,250	\$3,091,800
EXPENSE OBJECT:				
PERSONNEL SERVICES	\$ -	\$ -	\$ -	\$ -
MATERIALS & SUPPLIES	-	-	-	-
CONTRACTUAL SERVICES	-	-	-	-
GENERAL OPERATIONS	-	-	-	-
CAPITAL OUTLAY	-	-	-	-
SPECIAL PROJECTS	114,336	140,251	130,000	163,475
DEBT SERVICE	-	-	-	-
	<hr/>	<hr/>	<hr/>	<hr/>
TOTAL EXPENSES	\$ 114,336	\$ 140,251	\$ 130,000	\$ 163,475
FUND TRANSFERS IN	-	-	-	-
FUND TRANSFERS OUT	1,500,000	1,627,500	4,250,000	4,550,000
PROJECTED REVENUE				
OVER(UNDER) BUDGET			35,220	
PROJECTED EXPENDITURES				
UNDER(OVER) BUDGET			(10,000)	
RESERVED FUND BALANCE				
DECREASE(INCREASE)				
EMERGENCY RESERVE FUND BALANCE				
DECREASE(INCREASE)				-
BEGINNING UNRESERVED FUND				
BALANCE			3,915,243	2,191,713
ENDING UNRESERVED FUND				
BALANCE			<u>2,191,713</u>	<u>570,038</u>
EMERGENCY RESERVE FUND			<u>-</u>	<u>-</u>

CAPITAL IMPROVEMENT SALES TAX FUND  
(SEWER SYSTEM IMPROVEMENTS)  
BUDGET PROJECTIONS

	2017-18 <u>PROJECTED</u>	2018-19 <u>PROJECTED</u>	2019-20 <u>PROJECTED</u>	2020-21 <u>PROJECTED</u>	2021-22 <u>PROJECTED</u>
REVENUE SOURCE:					
TAXES	\$5,454,751	\$5,563,846	\$4,550,121	\$2,894,313	\$2,952,199
LICENSES AND PERMITS	-	-	-	-	-
INTERGOVERN REVENUE	-	-	-	-	-
SERVICE CHARGES	-	-	-	-	-
FINES AND FORFEITS	-	-	-	-	-
MISCELLANEOUS	11,374	15,648	19,093	12,822	8,217
OTHER FINANCING	-	-	-	-	-
<b>TOTAL REVENUE</b>	<b>\$5,466,125</b>	<b>\$5,579,494</b>	<b>\$4,569,214</b>	<b>\$2,907,135</b>	<b>\$2,960,416</b>
EXPENSE OBJECT:					
PERSONNEL SERVICES	\$ -	\$ -	\$ -	\$ -	\$ -
MATERIALS & SUPPLIES	-	-	-	-	-
CONTRACTUAL SERVICES	-	-	-	-	-
GENERAL OPERATIONS	-	-	-	-	-
CAPITAL OUTLAY	-	-	-	-	-
SPECIAL PROJECTS	291,239	297,064	242,939	154,532	157,623
DEBT SERVICE	-	-	-	-	-
<b>TOTAL EXPENSES</b>	<b>\$ 291,239</b>	<b>\$ 297,064</b>	<b>\$ 242,939</b>	<b>\$ 154,532</b>	<b>\$ 157,623</b>
FUND TRANSFERS IN	-	-	-	-	-
FUND TRANSFERS OUT	4,775,000	5,000,000	4,000,000	4,000,000	2,300,000
PROJECTED REVENUE OVER(UNDER) BUDGET					
PROJECTED EXPENDITURES UNDER(OVER) BUDGET					
RESERVED FUND BALANCE DECREASE(INCREASE)					
EMERGENCY RESERVE FUND BALANCE DECREASE(INCREASE)	-	-	-	-	-
BEGINNING UNRESERVED FUND BALANCE	570,038	969,924	1,252,354	1,578,629	331,232
ENDING UNRESERVED FUND BALANCE	<u>969,924</u>	<u>1,252,354</u>	<u>1,578,629</u>	<u>331,232</u>	<u>834,025</u>
EMERGENCY RESERVE FUND	<u>-</u>	<u>-</u>	<u>-</u>	<u>-</u>	<u>-</u>

CAPITAL IMPROVEMENT SALES TAX REVENUE  
(SEWER SYSTEM IMPROVEMENTS)

	<u>2013-14</u> <u>ACTUAL</u>	<u>2014-15</u> <u>ACTUAL</u>	<u>2015-16</u> <u>BUDGET</u>	<u>2016-17</u> <u>PROPOSED</u>
Capital Improvements Sales Tax	<u>\$2,448,930</u>	<u>\$2,538,309</u>	<u>\$2,606,250</u>	<u>\$3,061,800</u>
	2,448,930	2,538,309	2,606,250	3,061,800
Interest on Overnight Investments	<u>29,122</u>	<u>42,257</u>	<u>25,000</u>	<u>30,000</u>
	29,122	42,257	25,000	30,000
	<u>\$2,478,052</u>	<u>\$2,580,566</u>	<u>\$2,631,250</u>	<u>\$3,091,800</u>

CAPITAL IMPROVEMENT SALES TAX  
(SEWER SYSTEM IMPROVEMENTS)  
BUDGET BY MAJOR OBJECT

	2013-14 <u>ACTUAL</u>	2014-15 <u>ACTUAL</u>	2015-16 <u>BUDGET</u>	2016-17 <u>PROPOSED</u>
PERSONNEL COSTS	\$ -	\$ -	\$ -	\$ -
MATERIALS AND SUPPLIES	-	-	-	-
CONTRACTUAL SERVICES	-	-	-	-
GENERAL OPERATIONS	-	-	-	-
CAPITAL EXPENDITURES	-	-	-	-
SPECIAL PROJECTS	114,336	140,251	130,000	163,475
DEBT PAYMENTS	-	-	-	-
TRANSFERS	<u>1,500,000</u>	<u>1,627,500</u>	<u>4,250,000</u>	<u>4,550,000</u>
	<u>\$1,614,336</u>	<u>\$1,767,751</u>	<u>\$4,380,000</u>	<u>\$4,713,475</u>

---

# **FIRE SALES TAX FUND**

---

**FIRE SALES TAX FUND**  
**BUDGET HIGHLIGHTS**

**ACTIVITIES**

The Fire Sales Tax Fund is a fund established to account for receipt of ¼ cent sales tax authorized by the voters in June 2004 to fund operating and capital expenditures of the Fire department. The tax went into effect October 1, 2004. One-eighth of the tax expires December 31, 2035 and the remaining 1/8 does not expire. The total amount of the tax will be transferred each year to the General Fund to offset Fire operating and capital expenditures.

**REVENUE/EXPENDITURE PROJECTIONS**

Sales tax for the fiscal year ending June 30, 2017 is projected be 5.3% above the actual revenue for fiscal ending June 30, 2015.

**FIRE SALES TAX FUND  
2016-2017 RESOURCES**

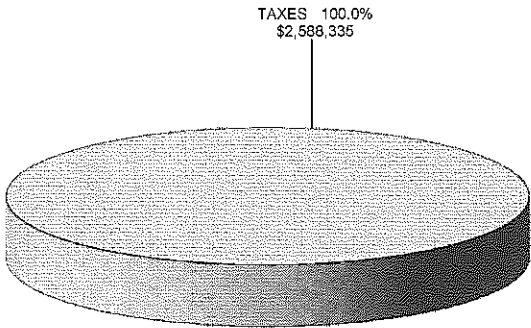



FIRE SALES TAX FUND  
BUDGET BY MAJOR OBJECT

	<u>2013-14</u> <u>ACTUAL</u>	<u>2014-15</u> <u>ACTUAL</u>	<u>2015-16</u> <u>BUDGET</u>	<u>2016-17</u> <u>BUDGET</u>
REVENUE SOURCE:				
TAXES	\$2,367,707	\$2,459,550	\$2,502,000	\$2,588,335
LICENSES AND PERMITS	-	-	-	-
INTERGOVERN REVENUE	-	-	-	-
SERVICE CHARGES	-	-	-	-
FINES AND FORFEITS	-	-	-	-
MISCELLANEOUS	-	-	-	-
OTHER FINANCING	-	-	-	-
	<hr/>	<hr/>	<hr/>	<hr/>
TOTAL REVENUE	\$2,367,707	\$2,459,550	\$2,502,000	\$2,588,335
EXPENSE OBJECT:				
PERSONNEL SERVICES	\$ -	\$ -	\$ -	\$ -
MATERIALS & SUPPLIES	-	-	-	-
CONTRACTUAL SERVICES	-	-	-	-
GENERAL OPERATIONS	-	-	-	-
CAPITAL OUTLAY	-	-	-	-
SPECIAL PROJECTS	-	-	-	-
DEBT SERVICE	-	-	-	-
	<hr/>	<hr/>	<hr/>	<hr/>
TOTAL EXPENSES	\$ -	\$ -	\$ -	\$ -
FUND TRANSFERS IN	-	-	-	-
FUND TRANSFERS OUT	2,302,317	2,509,834	2,502,000	2,588,335
PROJECTED REVENUE				
OVER(UNDER) BUDGET			35,600	
PROJECTED EXPENDITURES				
UNDER(OVER) BUDGET			(35,600)	
RESERVED FUND BALANCE				
DECREASE(INCREASE)				
EMERGENCY RESERVE FUND BALANCE				
DECREASE(INCREASE)				
BEGINNING UNRESERVED FUND				
BALANCE			225,263	225,263
ENDING UNRESERVED FUND				
BALANCE			<u>225,263</u>	<u>225,263</u>
EMERGENCY RESERVE FUND			<u>-</u>	<u>-</u>

---

FIRE SALES TAX FUND

	2013-14 ACTUAL	2014-15 ACTUAL	2015-16 BUDGET	2016-17 PROPOSED
Fire Sales Tax	<u>\$2,367,707</u>	<u>\$2,459,550</u>	<u>\$2,502,000</u>	<u>\$2,588,335</u>
	2,367,707	2,459,550	2,502,000	2,588,335
	<u>\$2,367,707</u>	<u>\$2,459,550</u>	<u>\$2,502,000</u>	<u>\$2,588,335</u>

---

FIRE SALES TAX FUND

BUDGET BY MAJOR OBJECT

	2012-13 <u>ACTUAL</u>	2013-14 <u>ACTUAL</u>	2014-15 <u>BUDGET</u>	2015-16 <u>PROPOSED</u>
PERSONNEL COSTS	\$ -	\$ -	\$ -	\$ -
MATERIALS AND SUPPLIES	-	-	-	-
CONTRACTUAL SERVICES	-	-	-	-
GENERAL OPERATIONS	-	-	-	-
CAPITAL EXPENDITURES	-	-	-	-
SPECIAL PROJECTS	-	-	-	-
DEBT PAYMENTS	-	-	-	-
TRANSFERS	<u>2,302,317</u>	<u>2,509,834</u>	<u>2,502,000</u>	<u>2,588,335</u>
	<u>\$2,302,317</u>	<u>\$2,509,834</u>	<u>\$2,502,000</u>	<u>\$2,588,335</u>

---

**PARKS/  
STORMWATER  
SALES TAX-  
CAPITAL  
FUND**

---

**PARKS/STORMWATER SALES TAX-CAPITAL FUND**  
**BUDGET HIGHLIGHTS**

**ACTIVITIES**

The Parks/Storm Water Sales Tax - Capital Fund is a fund established to account for receipt of 3/8 cent sales tax authorized by the voters in April 2008 to fund parks, recreation, and storm water capital projects and parks and recreation equipment expenditures. The tax went into effect October 1, 2008. This tax will expire December 31, 2018.

**REVENUE/EXPENDITURE PROJECTIONS**

Sales tax for the fiscal year ending June 30, 2017 is projected to be 5.4% above the actual sales tax for fiscal year ending June 30, 2015 and projected to increase 2% per year thereafter through the expiration of the tax. Revenues not used to pay debt service on the bonds issued to do a portion of the above projects or make equipment purchases will be transferred to capital project funds to do park and stormwater projects on a pay as you go basis.

**PARKS/STORMWATER SALES TAX-CAPITAL  
2016-2017 RESOURCES**

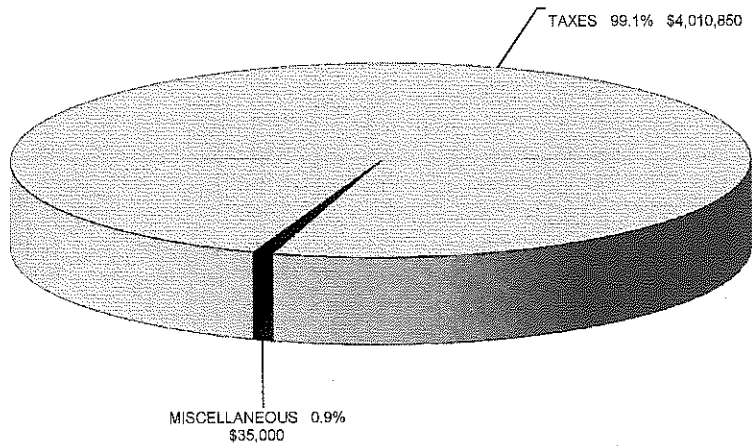

**PARK/STORMWATER SALES TAX - CAPITAL  
2016-2017 EXPENDITURES**

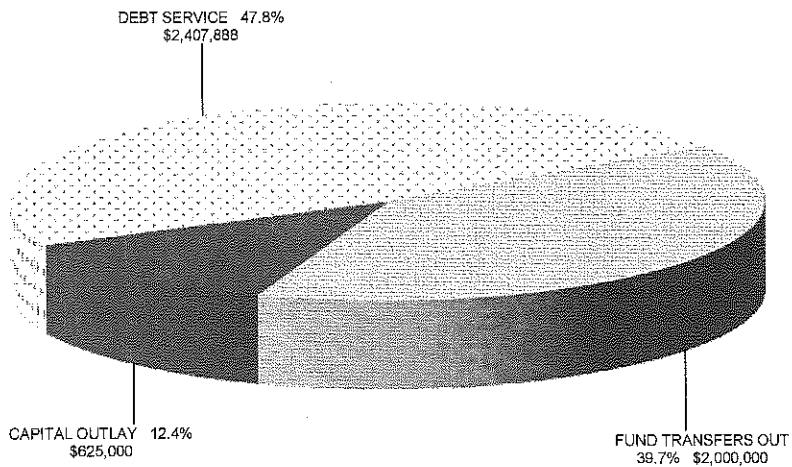

PARK/STORMWATER SALES TAX - CAPITAL  
BUDGET BY MAJOR OBJECT

	2013-14 <u>ACTUAL</u>	2014-15 <u>ACTUAL</u>	2015-16 <u>BUDGET</u>	2016-17 <u>BUDGET</u>
REVENUE SOURCE:				
TAXES	\$3,669,906	\$3,807,103	\$3,909,375	\$4,010,850
LICENSES AND PERMITS	-	-	-	-
INTERGOVERN REVENUE	-	-	-	-
SERVICE CHARGES	-	-	-	-
FINES AND FORFEITS	-	-	-	-
MISCELLANEOUS	42,115	57,118	25,000	35,000
OTHER FINANCING	<u>9,065</u>	<u>-</u>	<u>-</u>	<u>-</u>
TOTAL REVENUE	\$3,721,086	\$3,864,221	\$3,934,375	\$4,045,850
EXPENSE OBJECT:				
PERSONNEL SERVICES	\$ -	\$ -	\$ -	\$ -
MATERIALS & SUPPLIES	-	-	-	-
CONTRACTUAL SERVICES	-	-	-	-
GENERAL OPERATIONS	-	-	-	-
CAPITAL OUTLAY	166,043	46,735	274,500	625,000
SPECIAL PROJECTS	-	-	-	-
DEBT SERVICE	<u>2,490,922</u>	<u>2,490,309</u>	<u>2,487,594</u>	<u>2,407,888</u>
TOTAL EXPENSES	<u>\$2,656,965</u>	<u>\$2,537,044</u>	<u>\$2,762,094</u>	<u>\$3,032,888</u>
FUND TRANSFERS IN	30,000	30,000	-	-
FUND TRANSFERS OUT	193,436	700,116	2,753,000	2,000,000
PROJECTED REVENUE				
OVER(UNDER) BUDGET			61,025	
PROJECTED EXPENDITURES				
UNDER(OVER) BUDGET			(157,947)	
RESERVED FUND BALANCE				
DECREASE(INCREASE)				
EMERGENCY RESERVE FUND BALANCE				
DECREASE(INCREASE)			420	11,956
BEGINNING UNRESERVED FUND				
BALANCE			3,954,154	2,276,933
ENDING UNRESERVED FUND			<u>2,276,933</u>	<u>1,301,851</u>
BALANCE				
EMERGENCY RESERVE FUND		<u>373,559</u>	<u>373,139</u>	<u>361,183</u>

PARK/STORMWATER SALES TAX - CAPITAL  
BUDGET PROJECTIONS

	<u>2017-18</u> <u>PROJECTED</u>	<u>2018-19</u> <u>PROJECTED</u>	<u>2019-20</u> <u>PROJECTED</u>	<u>2020-21</u> <u>PROJECTED</u>	<u>2021-22</u> <u>PROJECTED</u>
REVENUE SOURCE:					
TAXES	\$4,091,067	\$2,453,658	\$ -	\$ -	\$ -
LICENSES AND PERMITS	-	-	-	-	-
INTERGOVERN REVENUE	-	-	-	-	-
SERVICE CHARGES	-	-	-	-	-
FINES AND FORFEITS	-	-	-	-	-
MISCELLANEOUS	20,000	7,750	-	-	-
OTHER FINANCING	-	-	-	-	-
<b>TOTAL REVENUE</b>	<u>\$4,111,067</u>	<u>\$2,461,408</u>	<u>\$ -</u>	<u>\$ -</u>	<u>\$ -</u>
EXPENSE OBJECT:					
PERSONNEL SERVICES	\$ -	\$ -	\$ -	\$ -	\$ -
MATERIALS & SUPPLIES	-	-	-	-	-
CONTRACTUAL SERVICES	-	-	-	-	-
GENERAL OPERATIONS	-	-	-	-	-
CAPITAL OUTLAY	975,000	975,000	-	-	-
SPECIAL PROJECTS	-	-	-	-	-
DEBT SERVICE	<u>2,407,500</u>	<u>1,575,900</u>	<u>-</u>	<u>-</u>	<u>-</u>
<b>TOTAL EXPENSES</b>	<u>\$3,382,500</u>	<u>\$2,550,900</u>	<u>\$ -</u>	<u>\$ -</u>	<u>\$ -</u>
FUND TRANSFERS IN	-	-	-	-	-
FUND TRANSFERS OUT	1,150,000	1,152,109	-	-	-
PROJECTED REVENUE OVER(UNDER) BUDGET					
PROJECTED EXPENDITURES UNDER(OVER) BUDGET					
RESERVED FUND BALANCE DECREASE(INCREASE)					
EMERGENCY RESERVE FUND BALANCE DECREASE(INCREASE)	58	361,125	-	-	-
BEGINNING UNRESERVED FUND BALANCE	1,301,851	880,476	-	-	-
ENDING UNRESERVED FUND BALANCE	<u>880,476</u>	<u>-</u>	<u>-</u>	<u>-</u>	<u>-</u>
EMERGENCY RESERVE FUND	<u>361,125</u>	<u>-</u>	<u>-</u>	<u>-</u>	<u>-</u>



PARK STORMWATER SALES TAX - CAPITAL

	2013-14 ACTUAL	2014-15 ACTUAL	2015-16 BUDGET	2016-17 PROPOSED
Park/Stormwater Sales Tax	<u>\$3,669,906</u>	<u>\$3,807,103</u>	<u>\$3,909,375</u>	<u>\$4,010,850</u>
	3,669,906	3,807,103	3,909,375	4,010,850
Interest on Overnight Investments	42,114	57,117	25,000	35,000
Interest on Inv Bond Proceeds	<u>1</u>	<u>1</u>	<u>-</u>	<u>-</u>
	42,115	57,118	25,000	35,000
Sale of Assets	<u>9,065</u>	<u>-</u>	<u>-</u>	<u>-</u>
	9,065	-	-	-
Transfer-A C Brase Foundation	<u>30,000</u>	<u>30,000</u>	<u>-</u>	<u>-</u>
	30,000	30,000	-	-
	<u><u>\$3,751,087</u></u>	<u><u>\$3,894,221</u></u>	<u><u>\$3,934,375</u></u>	<u><u>\$4,045,850</u></u>

---

PARK STORMWATER SALES TAX - CAPITAL

BUDGET BY MAJOR OBJECT

	2013-14 <u>ACTUAL</u>	2014-15 <u>ACTUAL</u>	2015-16 <u>BUDGET</u>	2016-17 <u>PROPOSED</u>
PERSONNEL COSTS	\$ -	\$ -	\$ -	\$ -
MATERIALS AND SUPPLIES	-	-	-	-
CONTRACTUAL SERVICES	-	-	-	-
GENERAL OPERATIONS	-	-	-	-
CAPITAL EXPENDITURES	166,043	46,735	274,500	625,000
SPECIAL PROJECTS	-	-	-	-
DEBT PAYMENTS	2,490,922	2,490,309	2,487,594	2,407,888
TRANSFERS	<u>193,436</u>	<u>700,116</u>	<u>2,753,000</u>	<u>2,000,000</u>
	<u>\$2,850,401</u>	<u>\$3,237,160</u>	<u>\$5,515,094</u>	<u>\$5,032,888</u>

---

THIS PAGE INTENTIONALLY LEFT BLANK

---

---

**PARKS/  
STORMWATER  
SALES TAX-  
OPERATIONS  
FUND**

---

**PARKS/STORMWATER SALES TAX-OPERATIONS FUND**  
**BUDGET HIGHLIGHTS**

**ACTIVITIES**

The Parks/Storm Water Sales Tax - Operations Fund is a fund established to account for receipt of 1/8 cent sales tax authorized by the voters in April 2008 to fund parks, recreation, and storm water operating expenditures. The tax went into effect October 1, 2008. This tax does not expire. Approximately 75% of the revenue from this fund will be transferred to the General, Parks and Recreation, Golf, and Softball Complex funds to cover additional personnel and operating expenses. The remaining revenue will be transferred to the Sewer Fund to cover additional storm water personnel and maintenance costs.

**REVENUE/EXPENDITURE PROJECTIONS**

Sales tax for the fiscal year ending June 30, 2017 is projected to be 5.4% above the actual sales tax for fiscal year ending June 30, 2015 and projected to increase 2% per year thereafter. All projected revenue will be used for capital expenditures or transferred to other funds.

**PARK/STORMWATER SALES TAX - OPERATIONS  
2016-2017 RESOURCES**

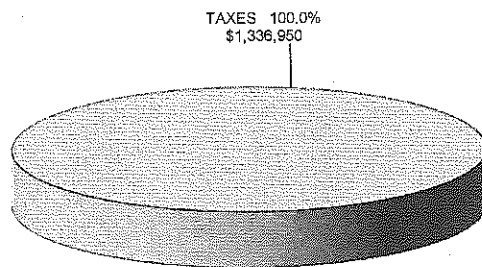

PARK/STORMWATER SALES TAX - OPERATIONS  
BUDGET BY MAJOR OBJECT

	<u>2013-14</u> <u>ACTUAL</u>	<u>2014-15</u> <u>ACTUAL</u>	<u>2015-16</u> <u>BUDGET</u>	<u>2016-17</u> <u>BUDGET</u>
REVENUE SOURCE:				
TAXES	\$1,223,302	\$1,269,034	\$1,303,125	\$1,336,950
LICENSES AND PERMITS	-	-	-	-
INTERGOVERN REVENUE	-	-	-	-
SERVICE CHARGES	-	-	-	-
FINES AND FORFEITS	-	-	-	-
MISCELLANEOUS	12,172	12,448	2,500	-
OTHER FINANCING	-	-	-	-
	<u>          </u>	<u>          </u>	<u>          </u>	<u>          </u>
TOTAL REVENUE	\$1,235,474	\$1,281,482	\$1,305,625	\$1,336,950
EXPENSE OBJECT:				
PERSONNEL SERVICES	\$ -	\$ -	\$ -	\$ -
MATERIALS & SUPPLIES	-	-	-	-
CONTRACTUAL SERVICES	-	-	-	-
GENERAL OPERATIONS	-	-	-	-
CAPITAL OUTLAY	-	-	-	-
SPECIAL PROJECTS	(9,200)	-	-	-
DEBT SERVICE	-	-	-	-
	<u>          </u>	<u>          </u>	<u>          </u>	<u>          </u>
TOTAL EXPENSES	\$ (9,200)	\$ -	\$ -	\$ -
FUND TRANSFERS IN	-	-	-	-
FUND TRANSFERS OUT	1,287,930	1,384,563	1,225,994	1,444,249
PROJECTED REVENUE				
OVER(UNDER) BUDGET			6,610	
PROJECTED EXPENDITURES				
UNDER(OVER) BUDGET			74,471	
RESERVED FUND BALANCE				
DECREASE(INCREASE)				
EMERGENCY RESERVE FUND BALANCE				
DECREASE(INCREASE)				
BEGINNING UNRESERVED FUND			314,493	475,205
BALANCE				
ENDING UNRESERVED FUND			<u>475,205</u>	<u>367,906</u>
BALANCE				
EMERGENCY RESERVE FUND			<u>          </u>	<u>          </u>

PARK/STORMWATER SALES TAX - OPERATIONS  
BUDGET PROJECTIONS

	2016-17 <u>PROJECTED</u>	2017-18 <u>PROJECTED</u>	2018-19 <u>PROJECTED</u>	2019-20 <u>PROJECTED</u>	2020-21 <u>PROJECTED</u>
REVENUE SOURCE:					
TAXES	\$1,363,689	\$1,390,963	\$1,418,782	\$1,447,158	\$1,476,101
LICENSES AND PERMITS	-	-	-	-	-
INTERGOVERN REVENUE	-	-	-	-	-
SERVICE CHARGES	-	-	-	-	-
FINES AND FORFEITS	-	-	-	-	-
MISCELLANEOUS	3,125	3,125	3,125	3,125	3,125
OTHER FINANCING	-	-	-	-	-
<b>TOTAL REVENUE</b>	<u>\$1,366,814</u>	<u>\$1,394,088</u>	<u>\$1,421,907</u>	<u>\$1,450,283</u>	<u>\$1,479,226</u>
EXPENSE OBJECT:					
PERSONNEL SERVICES	\$ -	\$ -	\$ -	\$ -	\$ -
MATERIALS & SUPPLIES	-	-	-	-	-
CONTRACTUAL SERVICES	-	-	-	-	-
GENERAL OPERATIONS	-	-	-	-	-
CAPITAL OUTLAY	172,984	180,812	188,919	197,188	205,741
SPECIAL PROJECTS	-	-	-	-	-
DEBT SERVICE	-	-	-	-	-
<b>TOTAL EXPENSES</b>	<u>\$ 172,984</u>	<u>\$ 180,812</u>	<u>\$ 188,919</u>	<u>\$ 197,188</u>	<u>\$ 205,741</u>
FUND TRANSFERS IN	-	-	-	-	-
FUND TRANSFERS OUT	1,193,830	1,213,276	1,232,988	1,253,095	1,273,485
PROJECTED REVENUE OVER(UNDER) BUDGET					
PROJECTED EXPENDITURES UNDER(OVER) BUDGET					
RESERVED FUND BALANCE DECREASE(INCREASE)					
EMERGENCY RESERVE FUND BALANCE DECREASE(INCREASE)					
BEGINNING UNRESERVED FUND BALANCE	367,906	367,906	367,906	367,906	367,906
ENDING UNRESERVED FUND BALANCE	<u>367,906</u>	<u>367,906</u>	<u>367,906</u>	<u>367,906</u>	<u>367,906</u>
EMERGENCY RESERVE FUND	<u>-</u>	<u>-</u>	<u>-</u>	<u>-</u>	<u>-</u>



PARK STORMWATER SALES TAX - OPERATIONS

	2013-14 ACTUAL	2014-15 ACTUAL	2015-16 BUDGET	2016-17 PROPOSED
Park/Stormwater Sales Tax	<u>\$1,223,302</u>	<u>\$1,269,034</u>	<u>\$1,303,125</u>	<u>\$1,336,950</u>
	1,223,302	1,269,034	1,303,125	1,336,950
Interest on Overnight Invmnts	<u>12,172</u>	<u>12,448</u>	<u>2,500</u>	<u>-</u>
	12,172	12,448	2,500	-
	<u>\$1,235,474</u>	<u>\$1,281,482</u>	<u>\$1,305,625</u>	<u>\$1,336,950</u>

---

PARK STORMWATER SALES TAX - OPERATIONS

BUDGET BY MAJOR OBJECT

	2013-14 <u>ACTUAL</u>	2014-15 <u>ACTUAL</u>	2015-16 <u>BUDGET</u>	2016-17 <u>PROPOSED</u>
PERSONNEL COSTS	\$ -	\$ -	\$ -	\$ -
MATERIALS AND SUPPLIES	-	-	-	-
CONTRACTUAL SERVICES	-	-	-	-
GENERAL OPERATIONS	-	-	-	-
CAPITAL EXPENDITURES	-	-	-	-
SPECIAL PROJECTS	(9,200)	-	-	-
DEBT PAYMENTS	-	-	-	-
TRANSFERS	<u>1,287,930</u>	<u>1,384,563</u>	<u>1,225,994</u>	<u>1,444,249</u>
	<u>\$1,278,730</u>	<u>\$1,384,563</u>	<u>\$1,225,994</u>	<u>\$1,444,249</u>

---

THIS PAGE INTENTIONALLY LEFT BLANK

---

---

**DEBT SERVICE FUND**  
**BUDGET HIGHLIGHTS**

Debt Service Fund accounts for the accumulation of funds required to pay principal and interest on the city's general long-term debt. Debt Service funds are administered by the Finance Department and are used to pay on city debt issued for general capital improvement projects such as streets and public buildings. The Debt Service Fund does not accumulate funds for payment of debt issued by the Sewer, Water, Solid Waste, Information Technology, and Equipment Replacement funds. Currently, there on no outstanding debt that will be repaid from this fund.

---

THIS PAGE INTENTIONALLY LEFT BLANK

---

---

# **GENERAL LONG-TERM BONDS FUND**

GENERAL LONG TERM BONDS  
BUDGET BY MAJOR OBJECT

	<u>2013-14</u> <u>ACTUAL</u>	<u>2014-15</u> <u>ACTUAL</u>	<u>2015-16</u> <u>BUDGET</u>	<u>2016-17</u> <u>BUDGET</u>
REVENUE SOURCE:				
TAXES	\$ -	\$ -	\$ -	\$ -
LICENSES AND PERMITS	-	-	-	-
INTERGOVERN REVENUE	-	-	-	-
SERVICE CHARGES	-	-	-	-
FINES AND FORFEITS	-	-	-	-
MISCELLANEOUS	324	-	-	-
OTHER FINANCING	-	-	-	-
	-	-	-	-
TOTAL REVENUE	\$ 324	\$ -	\$ -	\$ -
EXPENSE OBJECT:				
PERSONNEL SERVICES	\$ -	\$ -	\$ -	\$ -
MATERIALS & SUPPLIES	-	-	-	-
CONTRACTUAL SERVICES	-	-	-	-
GENERAL OPERATIONS	-	-	-	-
CAPITAL OUTLAY	-	-	-	-
SPECIAL PROJECTS	-	-	-	-
DEBT SERVICE	-	\$ -	-	-
	-	-	-	-
TOTAL EXPENSES	\$ -	\$ -	\$ -	\$ -
FUND TRANSFERS IN	-	-	-	-
FUND TRANSFERS OUT	-	26,335	-	-
PROJECTED REVENUE				
OVER(UNDER) BUDGET			-	
PROJECTED EXPENDITURES				
UNDER(OVER) BUDGET			-	
RESERVED FUND BALANCE				
DECREASE(INCREASE)			-	-
EMERGENCY RESERVE FUND BALANCE				
DECREASE(INCREASE)			-	-
BEGINNING UNRESERVED FUND				
BALANCE			-	-
ENDING UNRESERVED FUND				
BALANCE			-	-
EMERGENCY RESERVE FUND			-	-

GENERAL LONG TERM BONDS REVENUE

	<u>2013-14</u> <u>ACTUAL</u>	<u>2014-15</u> <u>ACTUAL</u>	<u>2015-16</u> <u>BUDGET</u>	<u>2016-17</u> <u>PROPOSED</u>
Interest on Overnight Investments	\$ 324	-	-	-
Interest on Assessments	-	-	-	-
	324	-	-	-
	<u>\$ 324</u>	<u>\$ -</u>	<u>\$ -</u>	<u>\$ -</u>



ANNUAL APPROPRIATION DEBT

BUDGET BY MAJOR OBJECT

	2013-14 <u>ACTUAL</u>	2014-15 <u>ACTUAL</u>	2015-16 <u>BUDGET</u>	2016-17 <u>PROPOSED</u>
PERSONNEL SERVICES	\$ -	\$ -	\$ -	\$ -
MATERIALS & SUPPLIES	-	-	-	-
CONTRACTUAL SERVICES	-	-	-	-
GENERAL OPERATING EXPENSE	-	-	-	-
CAPITAL OUTLAY	-	-	-	-
SPECIAL PROJECTS	-	-	-	-
DEBT SERVICE	-	-	-	-
TRANSFERS	-	26,335	-	-
	<u>\$ -</u>	<u>\$ 26,335</u>	<u>\$ -</u>	<u>\$ -</u>

---

## **CAPITAL PROJECTS FUNDS**

### **BUDGET HIGHLIGHTS**

Capital Projects Funds account for the acquisition and construction of capital facilities which may be financed out of bond issues, grants or transfers from other funds. These funds are administered by the Finance Department and include the following:

- General Capital Improvement Fund
- Street Improvement Fund
- Park Improvement Fund
- Surface Transportation Program-Urban Projects Fund
- Community Development Block Grant Fund

City of Cape Girardeau, Missouri  
 COMBINED STATEMENT OF REVENUES COLLECTED, EXPENDITURES PAID  
 AND CHANGES IN FUND BALANCES - CAPITAL PROJECTS FUNDS  
 GENERAL CAPITAL IMPROVEMENTS, CORP FLOOD CONTROL, STREET IMPROVEMENTS,  
 SURFACE TRANSPORTATION PROGRAM-URBAN PROJECTS FUND  
 CDBG GRANTS AND PARK IMPROVEMENTS  
 STORMWATER PROJECTS FROM PARKS/STORMWATER SALES TAX  
 PARK IMPROVEMENT PROJECTS FROM PARKS/STORMWATER SALES TAX

	2013-14 <u>ACTUAL</u>	2014-15 <u>ACTUAL</u>	2015-16 <u>BUDGET</u>	2016-17 <u>PROPOSED</u>
REVENUES COLLECTED:				
TAXES	\$ -	\$ -	\$ -	\$ -
LICENSES AND PERMITS	-	-	-	-
INTERGOVERN REVENUE	665,692	2,218,307	200,000	-
SERVICE CHARGES	-	-	-	-
FINES AND FORFEITS	-	-	-	-
MISCELLANEOUS	6,117	4,647	320	-
OTHER FINANCING	<u>15,298</u>	<u>14,414</u>	<u>4,105,323</u>	<u>-</u>
TOTAL REVENUE	\$ 687,107	\$ 2,237,368	\$ 4,305,643	\$ -
EXPENSE OBJECT:				
PERSONNEL SERVICES	\$ -	\$ -	\$ -	\$ -
MATERIALS & SUPPLIES	-	-	-	-
CONTRACTUAL SERVICES	-	-	-	-
GENERAL OPERATIONS	-	-	-	-
CAPITAL OUTLAY	714,261	1,376,085	4,300,000	15,715,000
SPECIAL PROJECTS	141,723	2,948,132	-	-
DEBT SERVICE	<u>561</u>	<u>1,328</u>	<u>-</u>	<u>-</u>
TOTAL EXPENSES	\$ 856,546	\$ 4,325,545	\$ 4,300,000	\$ 15,715,000
FUND TRANSFERS IN	5	1,681,869	-	-
FUND TRANSFERS OUT	2,524	-	-	-
PROJECTED REVENUE				
OVER(UNDER) BUDGET			33,569,564	
PROJECTED EXPENDITURES				
UNDER(OVER) BUDGET			(17,432,975)	
RESERVED FUND BALANCE				
DECREASE(INCREASE)			-	-
EMERGENCY RESERVE FUND BALANCE				
DECREASE(INCREASE)			-	-
BEGINNING UNRESERVED FUND				
BALANCE			(273,517)	15,868,715
ENDING UNRESERVED FUND				
BALANCE			<u>15,868,715</u>	<u>153,715</u>
EMERGENCY RESERVE FUND			<u>-</u>	<u>-</u>

---

# **GENERAL CAPITAL IMPROVEMENT FUND**

---

**GENERAL CAPITAL IMPROVEMENTS FUND**  
**BUDGET HIGHLIGHTS**

**ACTIVITIES**

The General Capital Improvements Fund is a fund established to account for major capital improvement projects, funded through local revenue sources, involving general public facilities. This budget proposes no major capital improvement projects.

GENERAL CAPITAL IMPROVEMENT FUND  
BUDGET BY MAJOR OBJECT

	2013-14 <u>ACTUAL</u>	2014-15 <u>ACTUAL</u>	2015-16 <u>BUDGET</u>	2016-17 <u>BUDGET</u>
REVENUE SOURCE:				
TAXES	\$ -	\$ -	\$ -	\$ -
LICENSES AND PERMITS	-	-	-	-
INTERGOVERN REVENUE	613,672	53,294	-	-
SERVICE CHARGES	-	-	-	-
FINES AND FORFEITS	-	-	-	-
MISCELLANEOUS	673	132	-	-
OTHER FINANCING	-	-	-	-
	<hr/>	<hr/>	<hr/>	<hr/>
TOTAL REVENUE	\$ 614,345	\$ 53,426	\$ -	\$ -
EXPENSE OBJECT:				
PERSONNEL SERVICES	\$ -	\$ -	\$ -	\$ -
MATERIALS & SUPPLIES	-	-	-	-
CONTRACTUAL SERVICES	-	-	-	-
GENERAL OPERATIONS	-	-	-	-
CAPITAL OUTLAY	726,410	8,409	-	15,715,000
SPECIAL PROJECTS	-	-	-	-
DEBT SERVICE	556	193	-	-
	<hr/>	<hr/>	<hr/>	<hr/>
TOTAL EXPENSES	\$ 726,967	\$ 8,602	\$ -	\$ 15,715,000
FUND TRANSFERS IN	-	-	-	-
FUND TRANSFERS OUT	-	-	-	-
PROJECTED REVENUE OVER(UNDER) BUDGET			32,491,538	
PROJECTED EXPENDITURES UNDER(OVER) BUDGET			(16,706,538)	
RESERVED FUND BALANCE DECREASE(INCREASE)				
EMERGENCY RESERVE FUND BUDGET DECREASE(INCREASE)				
BEGINNING UNRESERVED FUND BALANCE			31,220	15,816,220
ENDING UNRESERVED FUND BALANCE			<u>15,816,220</u>	<u>101,220</u>
EMERGENCY RESERVE FUND			<hr/> <hr/>	<hr/> <hr/>

---

THIS PAGE INTENTIONALLY LEFT BLANK

---

GENERAL CAPITAL IMPROVEMENT REVENUE

	2013-14 <u>ACTUAL</u>	2014-15 <u>ACTUAL</u>	2015-16 <u>BUDGET</u>	2016-17 <u>PROPOSED</u>
Federal Indirect Capital-Transpc	\$ 613,672	\$ 53,294	\$ -	\$ -
	613,672	53,294	-	-
Interest on Overnight Invments	673	132	-	-
	673	132	-	-
	<u>\$ 614,345</u>	<u>\$ 53,426</u>	<u>\$ -</u>	<u>\$ -</u>



---

GENERAL CAPITAL IMPROVEMENT

BUDGET BY MAJOR OBJECT

	2013-14 <u>ACTUAL</u>	2014-15 <u>ACTUAL</u>	2015-16 <u>BUDGET</u>	2016-17 <u>PROPOSED</u>
PERSONNEL COSTS	\$ -	\$ -	\$ -	\$ -
MATERIALS AND SUPPLIES	-	-	-	-
CONTRACTUAL SERVICES	-	-	-	-
GENERAL OPERATIONS	-	-	-	-
CAPITAL EXPENDITURES	726,410	8,409	-	15,715,000
SPECIAL PROJECTS	-	-	-	-
DEBT PAYMENTS	556	193	-	-
TRANSFERS	-	-	-	-
	<u>\$ 726,967</u>	<u>\$ 8,602</u>	<u>\$ -</u>	<u>\$ 15,715,000</u>

---

# **STREET IMPROVEMENT FUND**

---

## **STREET IMPROVEMENT FUND BUDGET HIGHLIGHTS**

### **ACTIVITIES**

The Street Improvement Fund accounts for the financing of street paving and reconstruction projects. Many of these projects provide a benefit to a specific group of properties and are financed through the issuance of special assessments to the property owners. This budget proposes no major capital improvement projects.

The current year's budget includes a \$4,100,000 new Sprigg Street Bridge project. This project is anticipated to be repaid from a future FEMA grant.

STREET IMPROVEMENT FUND  
BUDGET BY MAJOR OBJECT

	<u>2013-14</u> <u>ACTUAL</u>	<u>2014-15</u> <u>ACTUAL</u>	<u>2015-16</u> <u>BUDGET</u>	<u>2016-17</u> <u>BUDGET</u>
REVENUE SOURCE:				
TAXES	\$ -	\$ -	\$ -	\$ -
LICENSES AND PERMITS	-	-	-	-
INTERGOVERN REVENUE	-	-	-	-
SERVICE CHARGES	-	-	-	-
FINES AND FORFEITS	-	-	-	-
MISCELLANEOUS	4,273	3,363	320	-
OTHER FINANCING	<u>15,298</u>	<u>14,414</u>	<u>4,105,323</u>	<u>-</u>
TOTAL REVENUE	\$ 19,571	\$ 17,777	\$4,105,643	\$ -
EXPENSE OBJECT:				
PERSONNEL SERVICES	\$ -	\$ -	\$ -	\$ -
MATERIALS & SUPPLIES	-	-	-	-
CONTRACTUAL SERVICES	-	-	-	-
GENERAL OPERATIONS	-	-	-	-
CAPITAL OUTLAY	-	473,971	4,100,000	-
SPECIAL PROJECTS	-	-	-	-
DEBT SERVICE	<u>-</u>	<u>-</u>	<u>-</u>	<u>-</u>
TOTAL EXPENSES	<u>\$ -</u>	<u>\$ 473,971</u>	<u>\$4,100,000</u>	<u>\$ -</u>
FUND TRANSFERS IN	-	-	-	-
FUND TRANSFERS OUT	-	-	-	-
PROJECTED REVENUE				
OVER(UNDER) BUDGET			371,871	
PROJECTED EXPENDITURES				
UNDER(OVER) BUDGET			(25,650)	
RESERVED FUND BALANCE				
DECREASE(INCREASE)				
EMERGENCY RESERVE FUND BALANCE				
DECREASE(INCREASE)				
BEGINNING UNRESERVED FUND				
BALANCE			(350,596)	1,268
ENDING UNRESERVED FUND				
BALANCE			<u>1,268</u>	<u>1,268</u>
EMERGENCY RESERVE FUND			<u>-</u>	<u>-</u>

STREET IMPROVEMENT FUND REVENUE

	2013-14 <u>ACTUAL</u>	2014-15 <u>ACTUAL</u>	2015-16 <u>BUDGET</u>	2016-17 <u>PROPOSED</u>
Interest on Overnight Investments	\$ 1,158	\$ 991	\$ -	\$ -
Interest on Special Assessment	<u>3,115</u>	<u>2,372</u>	<u>320</u>	<u>-</u>
	4,273	3,363	320	-
Street Assessments-Current	15,298	14,414	5,323	-
Other notes or loans	<u>-</u>	<u>-</u>	<u>4,100,000</u>	<u>-</u>
	15,298	14,414	4,105,323	-
	<u>\$ 19,571</u>	<u>\$ 17,777</u>	<u>\$ 4,105,643</u>	<u>\$ -</u>

---

STREET IMPROVEMENT

BUDGET BY MAJOR OBJECT

	2013-14 <u>ACTUAL</u>	2014-15 <u>ACTUAL</u>	2015-16 <u>BUDGET</u>	2016-17 <u>PROPOSED</u>
PERSONNEL COSTS	\$ -	\$ -	\$ -	\$ -
MATERIALS AND SUPPLIES	-	-	-	-
CONTRACTUAL SERVICES	-	-	-	-
GENERAL OPERATIONS	-	-	-	-
CAPITAL EXPENDITURES	-	473,971	4,100,000	-
SPECIAL PROJECTS	-	-	-	-
DEBT PAYMENTS	-	-	-	-
TRANSFERS	-	-	-	-
	<u>\$ -</u>	<u>\$ 473,971</u>	<u>\$ 4,100,000</u>	<u>\$ -</u>

---

THIS PAGE INTENTIONALLY LEFT BLANK

---

---

# **PARK IMPROVEMENT FUND**



---

**PARK IMPROVEMENT FUND**  
**BUDGET HIGHLIGHTS**

**ACTIVITIES**

The Park Improvement Fund is established to account for capital projects directed for park improvements. No projects are included in this budget.

PARK IMPROVEMENT FUND  
BUDGET BY MAJOR OBJECT

	<u>2013-14</u> <u>ACTUAL</u>	<u>2014-15</u> <u>ACTUAL</u>	<u>2015-16</u> <u>BUDGET</u>	<u>2016-17</u> <u>BUDGET</u>
REVENUE SOURCE:				
TAXES	\$ -	\$ -	\$ -	\$ -
LICENSES AND PERMITS	-	-	-	-
INTERGOVERN REVENUE	-	794,861	-	-
SERVICE CHARGES	-	-	-	-
FINES AND FORFEITS	-	-	-	-
MISCELLANEOUS	234	352	-	-
OTHER FINANCING	-	-	-	-
	-	-	-	-
TOTAL REVENUE	\$ 234	\$ 795,213	\$ -	\$ -
EXPENSE OBJECT:				
PERSONNEL SERVICES	\$ -	\$ -	\$ -	\$ -
MATERIALS & SUPPLIES	-	-	-	-
CONTRACTUAL SERVICES	-	-	-	-
GENERAL OPERATIONS	-	-	-	-
CAPITAL OUTLAY	3,194	816,997	-	-
SPECIAL PROJECTS	-	-	-	-
DEBT SERVICE	-	-	-	-
	-	-	-	-
TOTAL EXPENSES	\$ 3,194	\$ 816,997	\$ -	\$ -
FUND TRANSFERS IN	-	17,624	-	-
FUND TRANSFERS OUT	-	-	-	-
PROJECTED REVENUE				
OVER(UNDER) BUDGET			64,489	
PROJECTED EXPENDITURES				
UNDER(OVER) BUDGET			(81,768)	
RESERVED FUND BALANCE				
DECREASE(INCREASE)				
EMERGENCY RESERVE FUND BALANCE				
DECREASE(INCREASE)				
BEGINNING UNRESERVED FUND				
BALANCE			17,279	-
ENDING UNRESERVED FUND				
BALANCE			-	-
EMERGENCY RESERVE FUND			-	-

PARK IMPROVEMENT FUND REVENUE

	<u>2013-14</u> <u>ACTUAL</u>	<u>2014-15</u> <u>ACTUAL</u>	<u>2015-16</u> <u>BUDGET</u>	<u>2016-17</u> <u>PROPOSED</u>
DOT - Mississippi River Walk IV	\$ -	\$ 794,861	\$ -	\$ -
	-	794,861	-	-
Interest on Overnight Investments	<u>234</u>	<u>352</u>	<u>-</u>	<u>-</u>
	234	352	-	-
Transfer-Park Impr Proj Fm Park Stormwater Tax	<u>-</u>	<u>17,624</u>	<u>-</u>	<u>-</u>
	-	17,624	-	-
	<u>\$ 234</u>	<u>\$ 812,837</u>	<u>\$ -</u>	<u>\$ -</u>

---

PARK IMPROVEMENT

BUDGET BY MAJOR OBJECT

	2013-14 <u>ACTUAL</u>	2014-15 <u>ACTUAL</u>	2015-16 <u>BUDGET</u>	2016-17 <u>PROPOSED</u>
PERSONNEL COSTS	\$ -	\$ -	\$ -	\$ -
MATERIALS AND SUPPLIES	-	-	-	-
CONTRACTUAL SERVICES	-	-	-	-
GENERAL OPERATIONS	-	-	-	-
CAPITAL EXPENDITURES	3,194	816,997	-	-
SPECIAL PROJECTS	-	-	-	-
DEBT PAYMENTS	-	-	-	-
TRANSFERS	-	-	-	-
	<u>\$ 3,194</u>	<u>\$ 816,997</u>	<u>\$ -</u>	<u>\$ -</u>

---

THIS PAGE INTENTIONALLY LEFT BLANK

---

---

**SURFACE  
TRANSPORTATION  
PROGRAM**

**URBAN  
PROJECTS  
FUND**

---

## **SURFACE TRANSPORTATION PROGRAM – URBAN PROJECTS FUND BUDGET HIGHLIGHTS**

### **ACTIVITIES**

The Surface Transportation Program – Urban Projects Fund accounts for the major street projects which are paid for with the assistance of the surface transportation program funds. This revenue is allocated to the City from the federal gasoline tax fund. Funds received from this program must be matched with 20% local revenue. No projects are included in this budget.

This current year's budget provides \$200,000 for Independence Street / Gordonville Road intersection improvements.

SURFACE TRANSPORTATION PROGRAM - URBAN PROJECTS FUND  
BUDGET BY MAJOR OBJECT

	<u>2013-14</u> <u>ACTUAL</u>	<u>2014-15</u> <u>ACTUAL</u>	<u>2015-16</u> <u>BUDGET</u>	<u>2016-17</u> <u>BUDGET</u>
REVENUE SOURCE:				
TAXES	\$ -	\$ -	\$ -	\$ -
LICENSES AND PERMITS	-	-	-	-
INTERGOVERN REVENUE	(25,104)	53,276	200,000	-
SERVICE CHARGES	-	-	-	-
FINES AND FORFEITS	-	-	-	-
MISCELLANEOUS	627	613	-	-
OTHER FINANCING	-	-	-	-
	-	-	-	-
TOTAL REVENUE	\$ (24,477)	\$ 53,889	\$ 200,000	\$ -
EXPENSE OBJECT:				
PERSONNEL SERVICES	\$ -	\$ -	\$ -	\$ -
MATERIALS & SUPPLIES	-	-	-	-
CONTRACTUAL SERVICES	-	-	-	-
GENERAL OPERATIONS	-	-	-	-
CAPITAL OUTLAY	(15,343)	76,708	200,000	-
SPECIAL PROJECTS	-	-	-	-
DEBT SERVICE	-	-	-	-
	-	-	-	-
TOTAL EXPENSES	\$ (15,343)	\$ 76,708	\$ 200,000	\$ -
FUND TRANSFERS IN	-	-	-	-
FUND TRANSFERS OUT	-	-	-	-
PROJECTED REVENUE				
OVER(UNDER) BUDGET			636,456	
PROJECTED EXPENDITURES				
UNDER(OVER) BUDGET			(612,773)	
RESERVED FUND BALANCE				
DECREASE(INCREASE)				
EMERGENCY RESERVE FUND				
DECREASE(INCREASE)				
BEGINNING UNRESERVED FUND				
BALANCE			27,544	51,227
ENDING UNRESERVED FUND				
BALANCE			51,227	51,227
EMERGENCY RESERVE FUND			-	-



SURFACE TRANSPORTATION PROGRAM - URBAN PROJECTS FUND REVENUE

	2013-14 <u>ACTUAL</u>	2014-15 <u>ACTUAL</u>	2015-16 <u>BUDGET</u>	2016-17 <u>PROPOSED</u>
DOT-Lewis and Clark Parkway Phase	\$ (25,104)	\$ -	\$ -	\$ -
Fd indirect cap-Transportation	<u>-</u>	<u>53,276</u>	<u>200,000</u>	<u>-</u>
	(25,104)	53,276	200,000	-
Interest on Overnight Invments	<u>627</u>	<u>613</u>	<u>-</u>	<u>-</u>
	627	613	-	-
	<u>\$ (24,477)</u>	<u>\$ 53,889</u>	<u>\$ 200,000</u>	<u>-</u>

---

SURFACE TRANSPORTATION PROGRAM - URBAN PROJECTS FUND

BUDGET BY MAJOR OBJECT

	2013-14 <u>ACTUAL</u>	2014-15 <u>ACTUAL</u>	2015-16 <u>BUDGET</u>	2016-17 <u>PROPOSED</u>
PERSONNEL COSTS	\$ -	\$ -	\$ -	\$ -
MATERIALS AND SUPPLIES	-	-	-	-
CONTRACTUAL SERVICES	-	-	-	-
GENERAL OPERATIONS	-	-	-	-
CAPITAL EXPENDITURES	(15,343)	76,708	200,000	-
SPECIAL PROJECTS	-	-	-	-
DEBT PAYMENTS	-	-	-	-
TRANSFERS	-	-	-	-
	<u>\$ (15,343)</u>	<u>\$ 76,708</u>	<u>\$ 200,000</u>	<u>\$ -</u>

---

THIS PAGE INTENTIONALLY LEFT BLANK

---

---

**CDBG**

**FUND**

---

**COMMUNITY DEVELOPMENT BLOCK GRANT FUND  
BUDGET HIGHLIGHTS**

**ACTIVITIES**

The Community Development Block Grant Fund accounts for the revenue and expenditures for rehabilitation of housing, capital projects and economic grants obtained from the Community Development Block Grant Program. The proposed budget includes no new projects.

CDBG GRANTS FUND  
BUDGET BY MAJOR OBJECT

	2013-14 <u>ACTUAL</u>	2014-15 <u>ACTUAL</u>	2015-16 <u>BUDGET</u>	2016-17 <u>BUDGET</u>
REVENUE SOURCE:				
TAXES	\$ -	\$ -	\$ -	\$ -
LICENSES AND PERMITS	-	-	-	-
INTERGOVERN REVENUE	77,124	1,316,876	-	-
SERVICE CHARGES	-	-	-	-
FINES AND FORFEITS	-	-	-	-
MISCELLANEOUS	310	187	-	-
OTHER FINANCING	-	-	-	-
	<hr/>	<hr/>	<hr/>	<hr/>
TOTAL REVENUE	\$ 77,434	\$ 1,317,063	\$ -	\$ -
EXPENSE OBJECT:				
PERSONNEL SERVICES	\$ -	\$ -	\$ -	\$ -
MATERIALS & SUPPLIES	-	-	-	-
CONTRACTUAL SERVICES	-	-	-	-
GENERAL OPERATIONS	-	-	-	-
CAPITAL OUTLAY	-	-	-	-
SPECIAL PROJECTS	141,723	2,948,132	-	-
DEBT SERVICE	5	1,135	-	-
	<hr/>	<hr/>	<hr/>	<hr/>
TOTAL EXPENSES	\$ 141,728	\$ 2,949,267	\$ -	\$ -
FUND TRANSFERS IN	5	1,664,245	-	-
FUND TRANSFERS OUT	2,524	-	-	-
PROJECTED REVENUE				
OVER(UNDER) BUDGET			5,210	
PROJECTED EXPENDITURES				
UNDER(OVER) BUDGET			(6,246)	
RESERVED FUND BALANCE				
DECREASE(INCREASE)				
EMERGENCY RESERVE FUND BALANCE				
DECREASE(INCREASE)				
BEGINNING UNRESERVED FUND				
BALANCE			1,036	-
ENDING UNRESERVED FUND				
BALANCE			<hr/>	<hr/>
EMERGENCY RESERVE FUND			<hr/>	<hr/>

CDBG GRANTS FUND REVENUE

	<u>2013-14</u> <u>ACTUAL</u>	<u>2014-15</u> <u>ACTUAL</u>	<u>2015-16</u> <u>BUDGET</u>	<u>2016-17</u> <u>PROPOSED</u>
HUD-Business Park Infrastructure	\$ 77,124	\$ 622,876	\$ -	\$ -
Fed Indirect Delta Reg Auth	-	194,000	-	-
Fed Indirect CDBG Bus Incubatr	-	500,000	-	-
	<u>77,124</u>	<u>1,316,876</u>	-	-
Interest on Overnight Inv.	<u>310</u>	<u>187</u>	-	-
	310	187	-	-
Transfer-General Fund	5	364	-	-
Transfer-Casino Rev Fund	-	55,000	-	-
Transfer-Watr Proj St.	-	1,608,881	-	-
	<u>5</u>	<u>1,664,245</u>	-	-
	<u>\$ 77,439</u>	<u>\$ 2,981,308</u>	<u>\$ -</u>	<u>\$ -</u>

---

CDBG GRANTS

BUDGET BY MAJOR OBJECT

	2013-14 <u>ACTUAL</u>	2014-15 <u>ACTUAL</u>	2015-16 <u>BUDGET</u>	2016-17 <u>PROPOSED</u>
PERSONNEL COSTS	\$ -	\$ -	\$ -	\$ -
MATERIALS AND SUPPLIES	-	-	-	-
CONTRACTUAL SERVICES	-	-	-	-
GENERAL OPERATIONS	-	-	-	-
CAPITAL EXPENDITURES	-	-	-	-
SPECIAL PROJECTS	141,723	2,948,132	-	-
DEBT PAYMENTS	5	1,135	-	-
TRANSFERS	<u>2,524</u>	<u>-</u>	<u>-</u>	<u>-</u>
	<u>\$ 144,252</u>	<u>\$ 2,949,267</u>	<u>\$ -</u>	<u>\$ -</u>



---

THIS PAGE INTENTIONALLY LEFT BLANK

---

---

**ENTERPRISE FUNDS**  
**BUDGET HIGHLIGHTS**

Enterprise Funds account for business type activities that are supported by user charges. The City of Cape Girardeau operates the water, sewer, solid waste utilities, golf course, indoor sports complexes, and softball complex as enterprise operations.

---

THIS PAGE INTENTIONALLY LEFT BLANK

---

## ENTERPRISE FUNDS 2016-2017 RESOURCES

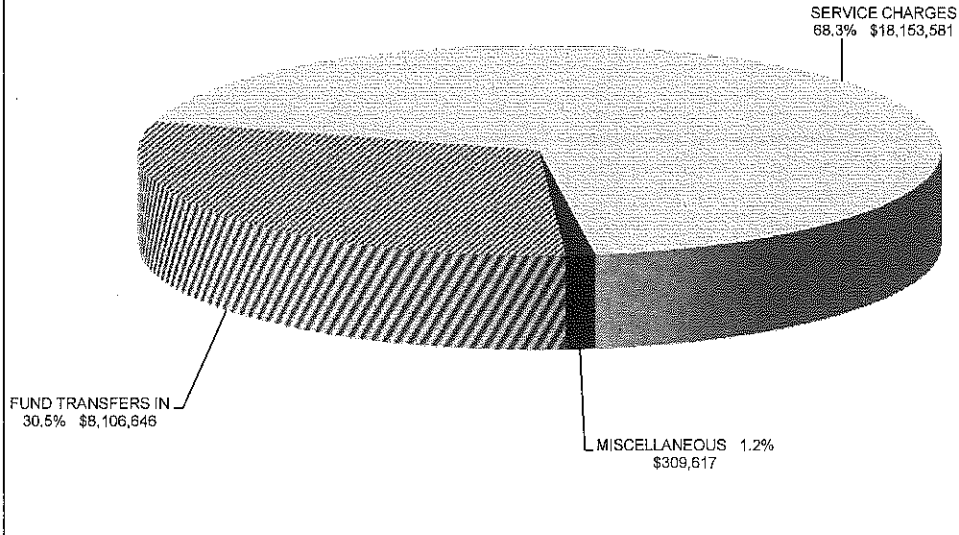

## ENTERPRISE FUNDS 2016-2017 EXPENDITURES

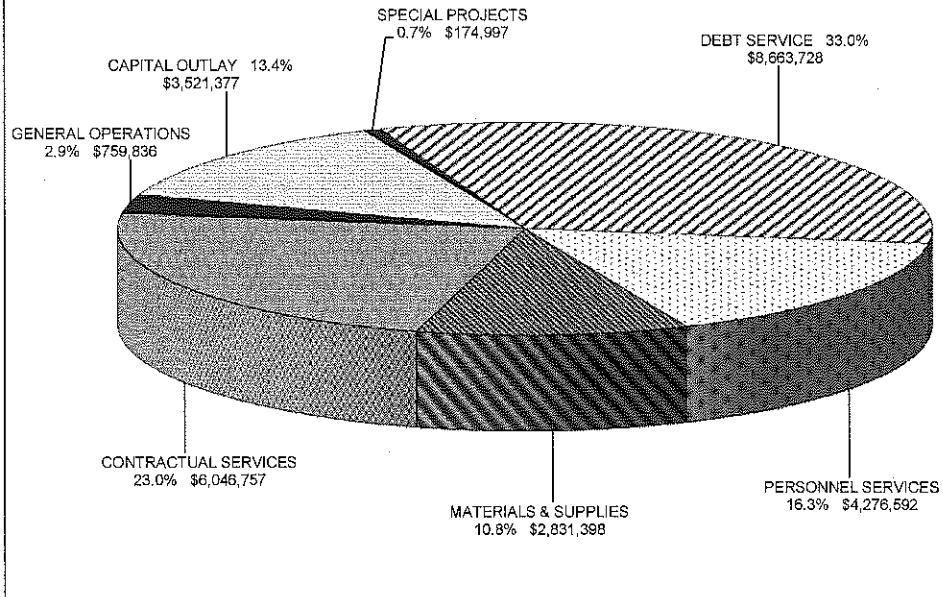

City of Cape Girardeau, Missouri  
 COMBINED STATEMENT OF REVENUES COLLECTED, EXPENDITURES PAID  
 AND CHANGES IN FUND BALANCES - ENTERPRISE FUNDS  
 SEWER, WATER, SOLID WASTE, GOLF COURSE, SPORTS COMPLEXES

	<u>2013-14</u> <u>ACTUAL</u>	<u>2014-15</u> <u>ACTUAL</u>	<u>2015-16</u> <u>BUDGET</u>	<u>2016-17</u> <u>PROPOSED</u>
REVENUES COLLECTED:				
TAXES	\$ -	\$ -	\$ -	\$ -
LICENSES AND PERMITS	-	-	-	-
INTERGOVERN REVENUE	10,958	-	-	-
SERVICE CHARGES	17,594,350	17,271,383	17,837,683	18,153,581
FINES AND FORFEITS	-	-	-	-
MISCELLANEOUS	368,648	331,010	266,099	309,617
OTHER FINANCING	<u>32,002,846</u>	<u>12,340,740</u>	<u>914,720</u>	<u>-</u>
TOTAL REVENUE	\$ 49,976,802	\$ 29,943,133	\$ 19,018,502	\$ 18,463,198
EXPENSE OBJECT:				
PERSONNEL SERVICES	\$4,069,765	\$4,112,560	\$4,258,636	\$4,276,592
MATERIALS & SUPPLIES	2,076,080	2,176,912	2,711,907	2,831,398
CONTRACTUAL SERVICES	5,352,232	5,563,581	5,347,805	6,046,757
GENERAL OPERATIONS	755,492	732,026	803,047	759,836
CAPITAL OUTLAY	7,397,026	5,968,780	8,775,500	3,521,377
SPECIAL PROJECTS	401,939	382,879	407,434	174,997
DEBT SERVICE	<u>4,353,819</u>	<u>5,569,998</u>	<u>8,356,144</u>	<u>8,663,728</u>
TOTAL EXPENSES	<u>\$24,406,352</u>	<u>\$24,496,737</u>	<u>\$30,660,473</u>	<u>\$26,274,685</u>
FUND TRANSFERS IN	2,572,527	5,382,494	11,877,578	8,106,646
FUND TRANSFERS OUT	1,810	5,422	-	-
PROJECTED REVENUE OVER(UNDER) BUDGET			9,362,661	
PROJECTED EXPENDITURES UNDER(OVER) BUDGET			(6,531,935)	
RESERVED FUND BALANCE DECREASE (INCREASE)			(172,262)	(220,379)
EMERGENCY RESERVE FUND BALANCE DECREASE (INCREASE)			(27,145)	(268,871)
BEGINNING UNRESERVED FUND BALANCE			(698,461)	2,168,465
ENDING UNRESERVED FUND BALANCE			<u>2,168,465</u>	<u>1,974,374</u>
EMERGENCY RESERVE FUND			<u>2,804,379</u>	<u>3,073,250</u>

---

# SEWER FUND

---

## **SEWER FUND BUDGET HIGHLIGHTS**

### **REVENUE/RATE INCREASES**

Revenue is projected based on projected residential and commercial usage for the current year and 2% rates increases effective with the first billing in July.

### **SIGNIFICANT OPERATING CHANGES**

In June 2010 voters approved bond authorization of \$72 million to design and construct a new sewer plant. Construction of the new plant was completed in the fall of 2014. This budget is based on the first full year of operation of the new sewer plant in which operating costs proved to be more expensive than anticipated.

Significant increases included in this budget were \$162,000 for contract disposal of bio-solids and \$130,500 in electricity expense. This budget also added an annual allowance of \$60,000 for lift station repairs.

### **CAPITAL IMPROVEMENT BUDGET AND EQUIPMENT REPLACEMENT**

This budget provides \$475,000 for items identified in the City's 2016 – 2021 Capital Improvement Program and \$125,827 for the purchase of two large pumps for the treatment plant. This budget allows for no equipment replacement from the fund's equipment replacement reserve.

### **REVENUE/EXPENSE PROJECTIONS**

Revenue projections assume projected 2015- 2016 usage levels for the 5-year period, no annual rate increases, and annual sewer connection fees of \$85,000. Additional rate increases are not likely to be needed during the 5-year period to meet projected bond coverage

Operating expenses, excluding personnel expenses and a \$60,000 professional fee are also projected to grow at a 2% rate of inflation. Allowances are made for \$60,000 in profession fees for all five years of the projection period. The City's bio-solids drying process is projected to be fully operational in the fiscal years after June 30, 2017. Operating expenses are reduced by \$112,000 annually as a result. Personnel expenditures are projected to include wage increases equal to the inflation rate in the fiscal years after June 30, 2017 and an annual turnover rate of 5%. Costs for health and dental insurance are projected to grow 6% and 3% annually, respectively, during these years.

During the five year period ending June 30, 2022 funding will be available to fund the equipment replacement plan, projects in the City's capital improvement plan, and \$375,000 annually for other projects. Debt service is projected using payments due on current bonds. Transfers from a capital improvement sales tax are made as required to meet debt service coverage.

## SEWER FUND 2016-2017 RESOURCES

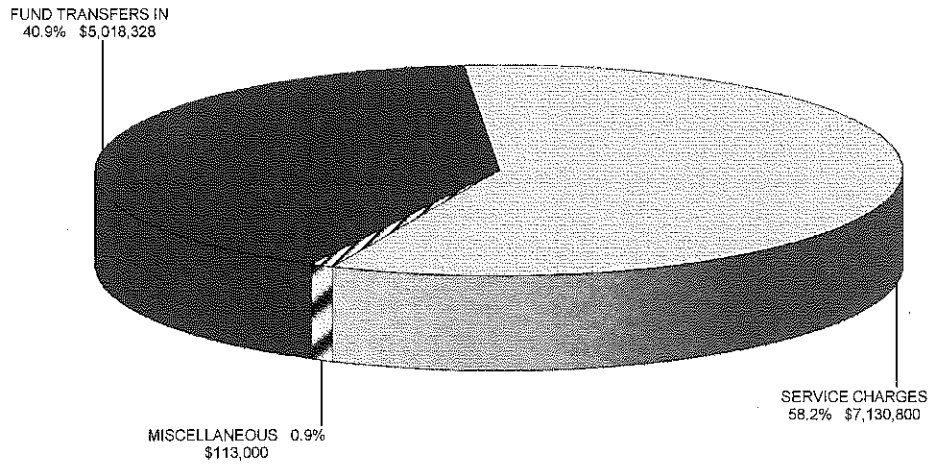

## SEWER FUND 2016-2017 EXPENDITURES

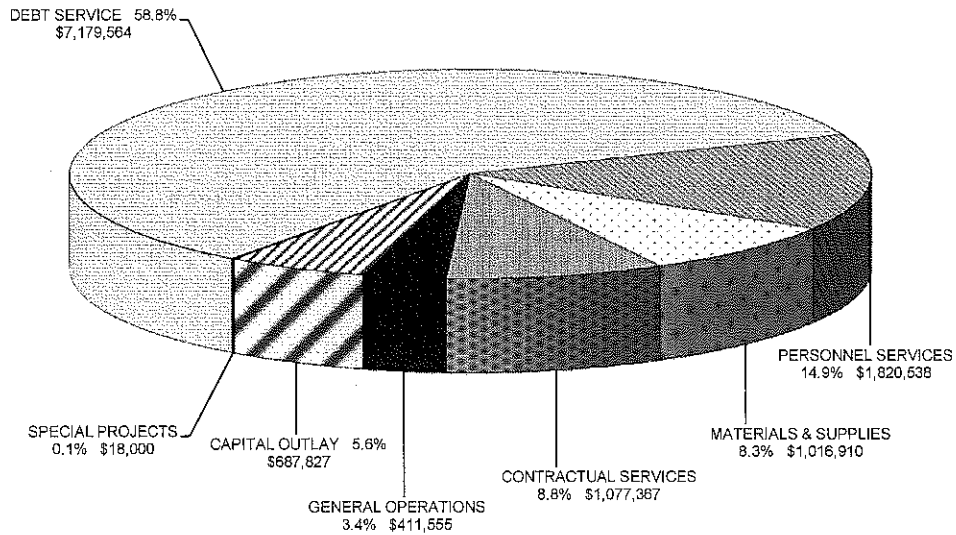



SEWER FUND  
BUDGET BY MAJOR OBJECT

	2013-14 <u>ACTUAL</u>	2014-15 <u>ACTUAL</u>	2015-16 <u>BUDGET</u>	2016-17 <u>BUDGET</u>
REVENUE SOURCE:				
TAXES	\$ -	\$ -	\$ -	\$ -
LICENSES AND PERMITS	-	-	-	-
INTERGOVERN REVENUE	10,958	-	-	-
SERVICE CHARGES	7,270,335	7,002,863	7,158,000	7,130,800
FINES AND FORFEITS	-	-	-	-
MISCELLANEOUS	206,665	183,436	131,253	113,000
OTHER FINANCING	<u>31,991,840</u>	<u>12,292,217</u>	<u>858,996</u>	<u>-</u>
TOTAL REVENUE	\$39,479,798	\$ 19,478,516	\$ 8,148,249	\$ 7,243,800
EXPENSE OBJECT:				
PERSONNEL SERVICES	\$1,689,090	\$1,750,599	\$1,814,588	\$1,820,538
MATERIALS & SUPPLIES	536,758	649,264	931,266	1,016,910
CONTRACTUAL SERVICES	697,462	1,017,277	671,966	1,077,367
GENERAL OPERATIONS	403,321	406,371	440,695	411,555
CAPITAL OUTLAY	4,981,709	3,962,361	1,472,500	687,827
SPECIAL PROJECTS	12,502	16,712	18,000	18,000
DEBT SERVICE	<u>2,855,346</u>	<u>3,320,255</u>	<u>7,108,347</u>	<u>7,179,564</u>
TOTAL EXPENSES	<u>\$11,176,187</u>	<u>\$11,122,839</u>	<u>\$12,457,362</u>	<u>\$12,211,761</u>
FUND TRANSFERS IN	1,791,268	2,111,150	4,560,274	5,018,328
FUND TRANSFERS OUT	1,810	3,422	-	-
PROJECTED REVENUE OVER(UNDER) BUDGET			5,904,146	
PROJECTED EXPENDITURES UNDER(OVER) BUDGET			(3,235,084)	
RESERVED FUND BALANCE DECREASE(INCREASE)			16,015	28,502
EMERGENCY RESERVE FUND BALANCE DECREASE(INCREASE)			-	(80,861)
BEGINNING UNRESERVED FUND BALANCE			(2,936,238)	-
ENDING UNRESERVED FUND BALANCE			<u>-</u>	<u>(1,992)</u>
EMERGENCY RESERVE FUND		<u>1,647,729</u>	<u>1,647,729</u>	<u>1,728,590</u>

SEWER FUND  
BUDGET PROJECTIONS

	<u>2017-18</u> <u>PROJECTED</u>	<u>2018-19</u> <u>PROJECTED</u>	<u>2019-20</u> <u>PROJECTED</u>	<u>2020-21</u> <u>PROJECTED</u>	<u>2021-22</u> <u>PROJECTED</u>
REVENUE SOURCE:					
TAXES	\$ -	\$ -	\$ -	\$ -	\$ -
LICENSES AND PERMITS	-	-	-	-	-
INTERGOVERN REVENUE	-	-	-	-	-
SERVICE CHARGES	7,130,800	7,130,800	7,130,800	7,130,800	7,130,800
FINES AND FORFEITS	-	-	-	-	-
MISCELLANEOUS	100,012	103,127	106,205	108,261	109,180
OTHER FINANCING	-	-	-	-	-
<b>TOTAL REVENUE</b>	<b>\$7,230,812</b>	<b>\$7,233,927</b>	<b>\$7,237,005</b>	<b>\$7,239,061</b>	<b>\$7,239,980</b>
EXPENSE OBJECT:					
PERSONNEL SERVICES	\$ 1,862,899	\$ 1,908,499	\$ 1,955,680	\$ 2,004,516	\$ 2,055,086
MATERIALS & SUPPLIES	1,046,887	1,067,825	1,089,182	1,110,966	1,133,185
CONTRACTUAL SERVICES	922,274	939,519	957,109	975,051	993,352
GENERAL OPERATIONS	419,786	428,182	436,746	445,481	454,391
CAPITAL OUTLAY	663,624	672,283	681,201	690,387	699,849
SPECIAL PROJECTS	18,360	18,727	19,102	19,484	19,874
DEBT SERVICE	6,237,386	7,212,764	6,257,568	6,184,937	4,540,641
<b>TOTAL EXPENSES</b>	<b>\$11,171,216</b>	<b>\$12,247,799</b>	<b>\$11,396,588</b>	<b>\$11,430,822</b>	<b>\$9,896,378</b>
FUND TRANSFERS IN	4,124,695	5,331,189	4,337,813	4,344,569	2,651,460
FUND TRANSFERS OUT	-	-	-	-	-
PROJECTED REVENUE OVER(UNDER) BUDGET					
PROJECTED EXPENDITURES UNDER(OVER) BUDGET					
RESERVED FUND BALANCE DECREASE(INCREASE)	(336,505)	(157,151)	(307,271)	(149,074)	(142,744)
EMERGENCY RESERVE FUND BALANCE DECREASE(INCREASE)	152,451	(160,188)	129,019	(3,757)	231,586
BEGINNING UNRESERVED FUND BALANCE	(1,992)	(1,755)	(1,777)	(1,799)	(1,822)
ENDING UNRESERVED FUND BALANCE	<u>(1,755)</u>	<u>(1,777)</u>	<u>(1,799)</u>	<u>(1,822)</u>	<u>82,082</u>
EMERGENCY RESERVE FUND	<u>1,576,139</u>	<u>1,736,327</u>	<u>1,607,308</u>	<u>1,611,065</u>	<u>1,379,479</u>

---

THIS PAGE INTENTIONALLY LEFT BLANK

---

## SEWER FUND REVENUE

	2013-14 <u>ACTUAL</u>	2014-15 <u>ACTUAL</u>	2015-16 <u>BUDGET</u>	2016-17 <u>PROPOSED</u>
FEMA - Capital Grant	\$ 9,669	\$ -	\$ -	\$ -
SEMA Disaster Grant	<u>1,289</u>	<u>-</u>	<u>-</u>	<u>-</u>
	10,958	-	-	-
Residential Sewer Usage	4,588,281	4,397,074	4,515,000	4,488,000
Commercial Sewer Usage	2,431,874	2,362,124	2,400,000	2,412,300
Waste Haulers Dumping Fees	24,461	27,416	25,000	18,000
Penalty	125,663	127,625	128,000	127,500
Donation	10,000	-	-	-
Sewer Connection Fees	<u>78,598</u>	<u>81,170</u>	<u>90,000</u>	<u>85,000</u>
	7,258,878	6,995,409	7,158,000	7,130,800
Interest-Restrict Inv-SRF Bond	102,166	90,705	80,000	60,000
Interest on Overnight Investment	95,257	90,885	50,000	50,000
Interest on Special Assessment	641	478	253	-
General Miscellaneous	<u>8,601</u>	<u>1,368</u>	<u>1,000</u>	<u>3,000</u>
	206,665	183,436	131,253	113,000
Proceeds from Sale of Assets	16,938	-	-	-
Property sale (Proprietary)	-	70,622	56,665	-
Proceeds from Trade-in of Asse	-	55,000	-	-
SRF Revenue Bond Proceeds	31,971,368	12,156,055	800,000	-
Special Assessment	<u>3,534</u>	<u>10,540</u>	<u>2,331</u>	<u>-</u>
	31,991,840	12,292,217	858,996	-
Project Personnel Cost	<u>11,457</u>	<u>7,454</u>	<u>-</u>	<u>-</u>
	11,457	7,454	-	-
Transfers - General Fund	-	9,370	-	-
Transfer-Capital Imp. Sales Tax	1,500,000	1,627,500	4,250,000	4,550,000
Transfer-Sewer Project Fund	-	174,800	-	-
Transfer - Park/Stormwater - Operating	<u>291,268</u>	<u>299,480</u>	<u>310,274</u>	<u>468,328</u>
	1,791,268	2,111,150	4,560,274	5,018,328
	<u>\$41,271,066</u>	<u>\$21,589,666</u>	<u>\$12,708,523</u>	<u>\$12,262,128</u>

## Stormwater

This division maintains stormwater drainage and retention facilities accepted by the City from private developers or neighborhoods and will assume maintenance of completed portions of the Army Corp of Engineers Flood Control Project. This division also provides nuisance abatement services.

## 2016-2017 Proposed Budget

### Sewer Fund

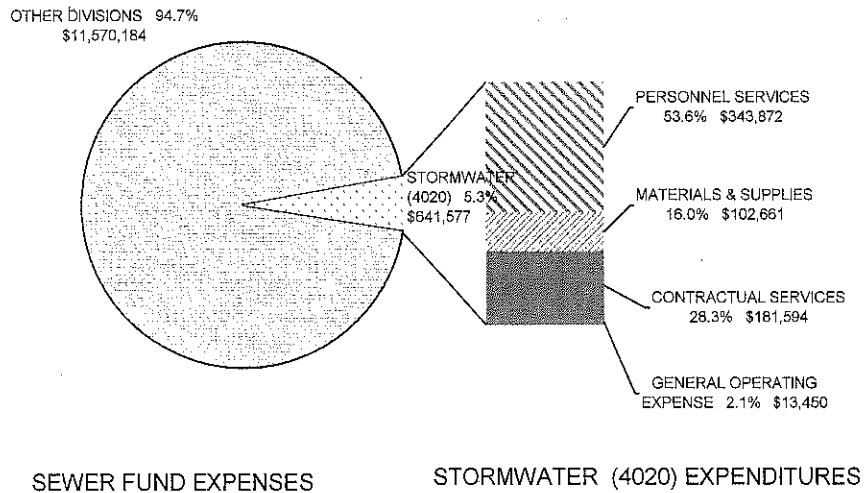

STORMWATER (4020)

BUDGET BY MAJOR OBJECT

	2013-14 <u>ACTUAL</u>	2014-15 <u>ACTUAL</u>	2015-16 <u>BUDGET</u>	2016-17 <u>PROPOSED</u>
PERSONNEL COSTS	\$379,620	\$314,144	\$337,138	\$343,872
MATERIALS AND SUPPLIES	86,499	87,288	102,161	102,661
CONTRACTUAL SERVICES	218,454	428,123	166,861	181,594
GENERAL OPERATIONS	4,833	7,885	11,450	13,450
CAPITAL EXPENDITURES	2,455,763	236,944	56,500	-
SPECIAL PROJECTS	-	-	-	-
DEBT PAYMENTS	-	-	-	-
TRANSFERS	-	-	-	-
	<u>\$3,145,169</u>	<u>\$1,074,384</u>	<u>\$674,110</u>	<u>\$641,577</u>

TOTAL PERSONNEL SERVICE BY POSITION  
STORMWATER

CLASSIFICATION	SALARY GRADE (Details in Appendices)		2015-2016 FISCAL YEAR	2016-2017 FISCAL YEAR
Regular Employees				
Assistant Public Works Director	Grade	U	0.125	0.125
Storm/Sewer Supervisor	Grade	Q	0.5	0.5
Stormwater Crewleader	Grade	L	1	1
PW System/GIS Analyst	Grade	L	0.25	0.25
Street/Stormwater Inspector	Grade	K	0.5	0.5
Stormwater Maintenance Worker II	Grade	G	<u>4</u>	<u>4</u>
TOTAL			6.375	6.375

## Main Street Levees

During the fiscal year ending June 30, 2008 the assets and operations of the Main Street Levee District and North Main Street Levee District were assumed by the City. This division accounts for the operations of these two districts.

## 2016-2017 Proposed Budget Sewer Fund

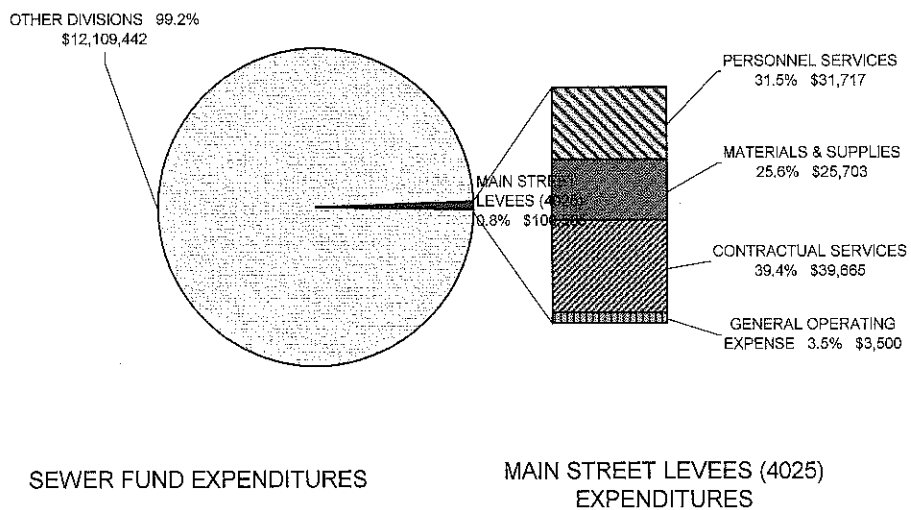

MAIN STREET LEVEES (4025)

BUDGET BY MAJOR OBJECT

	2013-14 <u>ACTUAL</u>	2014-15 <u>ACTUAL</u>	2015-16 <u>BUDGET</u>	2016-17 <u>PROPOSED</u>
PERSONNEL COSTS	\$ 376	\$ -	\$ 31,105	\$ 31,717
MATERIALS AND SUPPLIES	13,870	15,341	20,400	25,703
CONTRACTUAL SERVICES	21,959	46,862	25,316	39,665
GENERAL OPERATIONS	1,934	666	3,500	3,500
CAPITAL EXPENDITURES	856	-	-	-
SPECIAL PROJECTS	-	-	-	-
DEBT PAYMENTS	-	-	-	-
TRANSFERS	-	-	-	-
	<u>\$ 38,994</u>	<u>\$ 62,869</u>	<u>\$ 80,321</u>	<u>\$ 100,585</u>

TOTAL PERSONNEL SERVICE BY POSITION  
MAIN STREET LEVEES

Part-Time Employees

	2015-2016		2016-2017	
	<u>Actual Hours</u>	<u>Full-Time Equivalent</u>	<u>Actual Hours</u>	<u>Full-Time Equivalent</u>
General Worker	<u>1,750</u>	<u>0.84</u>	<u>1,750</u>	<u>0.84</u>
	1,750	0.84	1,750	0.84



## Sludge Operations

The sludge division removes approximately 1,300 dry tons of sludge per year from the wastewater. Sludge is hauled by tractor trucks to farms and land-applied for the fertilizer content. The sludge program involves labor, testing, hauling, and farming practices. With the addition of the pathogen reduction system, the City meets the current Environmental Protection Agency and Missouri Department of Natural Resources rules and regulations.

## 2016-2017 Proposed Budget

### Sewer Fund

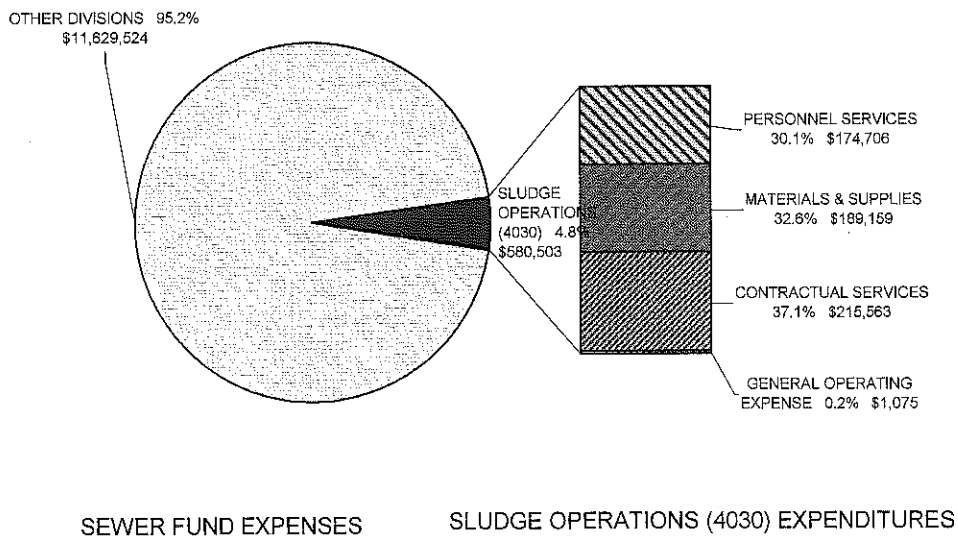

SLUDGE OPERATIONS (4030)

BUDGET BY MAJOR OBJECT

	2013-14 <u>ACTUAL</u>	2014-15 <u>ACTUAL</u>	2015-16 <u>BUDGET</u>	2016-17 <u>PROPOSED</u>
PERSONNEL COSTS	\$170,714	\$213,148	\$180,549	\$174,706
MATERIALS AND SUPPLIES	63,848	90,906	236,216	189,159
CONTRACTUAL SERVICES	53,664	131,423	60,303	215,563
GENERAL OPERATIONS	572	280	1,075	1,075
CAPITAL EXPENDITURES	-	53,980	-	-
SPECIAL PROJECTS	-	-	-	-
DEBT PAYMENTS	-	-	-	-
TRANSFERS	-	-	-	-
	<u>\$288,798</u>	<u>\$489,737</u>	<u>\$478,143</u>	<u>\$580,503</u>

TOTAL PERSONNEL SERVICE BY POSITION  
SLUDGE OPERATIONS

CLASSIFICATION	SALARY GRADE (Details in Appendices)		2015-2016 FISCAL YEAR	2016-2017 FISCAL YEAR
Regular Employees				
Wastewater Crew Leader	Grade	L	1	1
Wastewater Treatment Operator	Grade	J	<u>2</u>	<u>2</u>
TOTAL			3	3

## Wastewater Operations

The wastewater operations division operates and maintains a seven million gallon per day trickling filter treatment plant. Plant operations involve lift stations, grit stations, industrial pretreatment program, laboratory testing, record keeping, and maintenance of the overall plant. The plant meets the Environmental Protection Agency and Missouri Department of Natural Resources required parameters.

## 2016-2017 Proposed Budget

### Sewer Fund

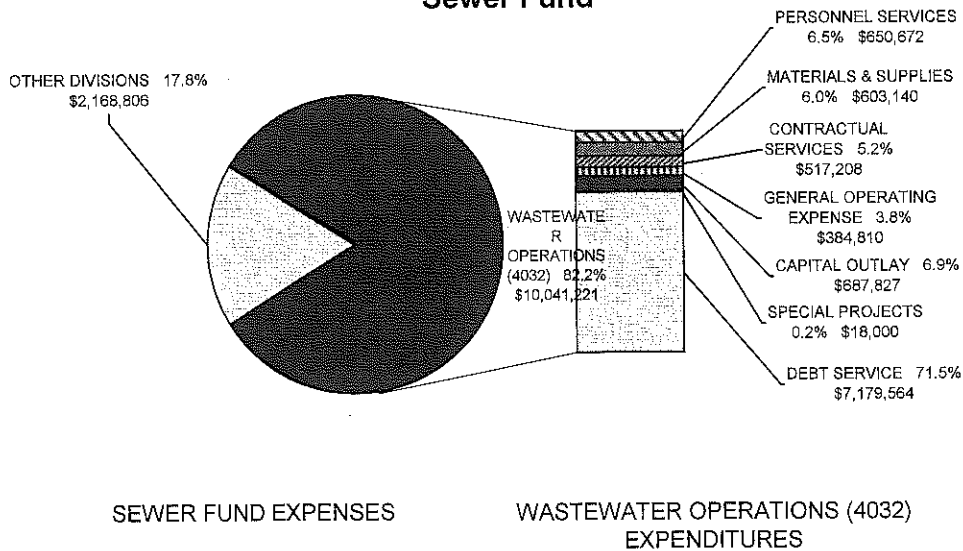

WASTEWATER OPERATIONS (4032)

BUDGET BY MAJOR OBJECT

	2013-14 <u>ACTUAL</u>	2014-15 <u>ACTUAL</u>	2015-16 <u>BUDGET</u>	2016-17 <u>PROPOSED</u>
PERSONNEL COSTS	\$611,954	\$651,960	\$639,834	\$650,672
MATERIALS AND SUPPLIES	275,725	376,298	456,123	603,140
CONTRACTUAL SERVICES	291,703	303,362	303,333	517,208
GENERAL OPERATIONS	389,564	391,529	420,500	384,810
CAPITAL EXPENDITURES	2,138,266	1,714,649	342,000	687,827
SPECIAL PROJECTS	12,502	16,712	18,000	18,000
DEBT PAYMENTS	2,855,346	3,320,255	7,108,347	7,179,564
TRANSFERS	1,810	3,422	-	-
	<u>\$6,576,869</u>	<u>\$6,778,187</u>	<u>\$9,288,137</u>	<u>\$10,041,221</u>

TOTAL PERSONNEL SERVICE BY POSITION  
WASTEWATER OPERATIONS

CLASSIFICATION	SALARY GRADE (Details in Appendices)		2015-2016 FISCAL YEAR	2016-2017 FISCAL YEAR
Regular Employees				
Assistant Public Works Director	Grade	U	0.25	0.25
Wastewater Treatment Coordinator	Grade	Q	1	1
Wastewater Chief Operator	Grade	O	1	1
Pretreatment Coordinator	Grade	M	1	1
Wastewater Specialist	Grade	L	1	1
Wastewater Plant Mechanic	Grade	K	3	3
Wastewater Treatment Operator	Grade	J	3	3
Senior Customer Service Rep.	Grade	G	0.30	0.30
Customer Serv. Reps.	Grade	F	1.3666	1.3666
TOTAL			11.9166	11.9166

## Sewer Line Maintenance

The sewer line maintenance division maintains over two hundred miles of sewer lines. This division includes preventive maintenance, television inspection, routine maintenance, point repairs, flat grate cleaning, sewer separation and maintenance as required.

## 2016-2017 Proposed Budget

### Sewer Fund

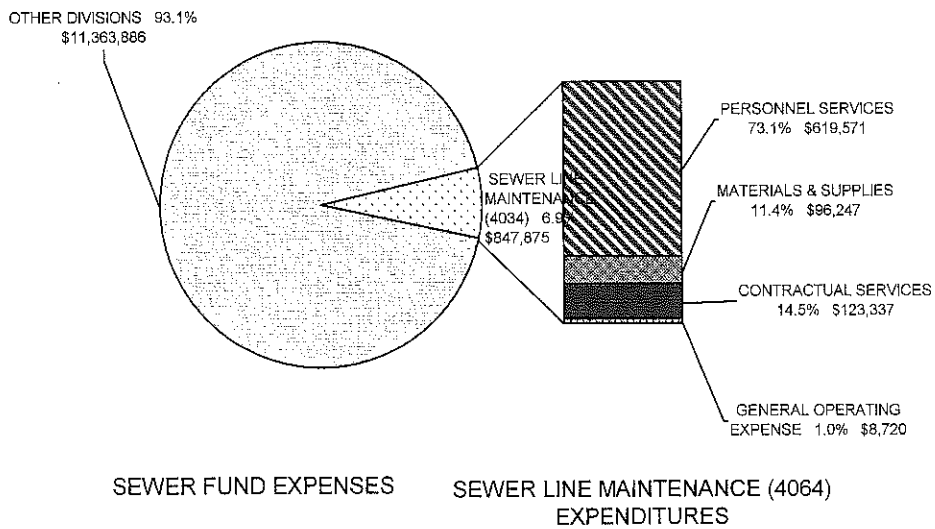

SEWER LINE MAINTENANCE (4034)

BUDGET BY MAJOR OBJECT

	2013-14 <u>ACTUAL</u>	2014-15 <u>ACTUAL</u>	2015-16 <u>BUDGET</u>	2016-17 <u>PROPOSED</u>
PERSONNEL COSTS	\$526,427	\$571,347	\$625,962	\$619,571
MATERIALS AND SUPPLIES	96,816	79,431	116,366	96,247
CONTRACTUAL SERVICES	111,683	107,506	116,153	123,337
GENERAL OPERATIONS	6,417	6,012	4,170	8,720
CAPITAL EXPENDITURES	386,825	1,956,788	1,074,000	-
SPECIAL PROJECTS	-	-	-	-
DEBT PAYMENTS	-	-	-	-
TRANSFERS	-	-	-	-
	<u>\$1,128,167</u>	<u>\$2,721,084</u>	<u>\$1,936,651</u>	<u>\$847,875</u>

TOTAL PERSONNEL SERVICE BY POSITION  
SEWER LINE MAINTENANCE

CLASSIFICATION	SALARY GRADE (Details in Appendices)		2015-2016 FISCAL YEAR	2016-2017 FISCAL YEAR
Regular Employees				
Public Works Director	Grade	V	0.20	0.20
Director of Citizens Services	Grade	U	0.10	0.10
Maintenance Supervisor	Grade	Q	0.50	0.50
Customer Service Manager	Grade	P	0.25	0.25
Sewer Maintenance Crew Leader	Grade	L	2	2
PW System/GIS Analyst	Grade	L	0.125	0.125
Maintenance Worker II	Grade	G	10	10
TOTAL			13.175	13.175

---

THIS PAGE INTENTIONALLY LEFT BLANK

---

---

# **WATER FUND**



---

## **WATER FUND** **BUDGET HIGHLIGHTS**

### **REVENUE/RATE INCREASES**

Revenue is projected based on projected residential and commercial usage for the current year and 3% rates increases effective with the first billing in July. 2/3 of the revenue produced by this rate increase will be used to fund a reserve for future capital improvements. Approximately \$585,000 of the previous 5 years' rates had been reserved for future capital improvements.

### **SIGNIFICANT OPERATING CHANGES**

This budget does not include any significant operating changes

### **CAPITAL IMPROVEMENT BUDGET AND EQUIPMENT REPLACEMENT**

The current budget provides \$2,730,000, \$2,145,000, and \$435,000 to complete the LaSalle Tank, LaSalle BPS / Generator and Perryville / Boutin Transmission Main, and Cape Rock / Perryville BPS and Generator projects. The majority of these amounts represented unspent funds from the previous year. It also provided \$1,339,500 to construct a booster pump station at Gordonville Road and to paint the Gordonville Water Tank

This budget includes \$1,486,000, and \$348,500, respectively, for improvements and upgrades to Plant #1 and pressure improvements. This budget also provides an additional \$490,800 for the Gordonville Water Tank painting project. This budget also provides an additional \$486,750 for main extensions, distribution improvements, main replacements, excavator replacement, and service truck replacements.

### **REVENUE/EXPENSE PROJECTIONS**

Revenue projections assume projected 2015 – 2016 usage levels for the 5-year period and annual 3.25% rate increases. Operating expenses, excluding personnel expenses are also projected to grow at a 2% rate of inflation. Personnel expenditures are projected to include wage increases equal to the inflation rate in the fiscal years after June 30, 2017 and an annual turnover rate of 5%. Costs for health and dental insurance are projected to grow 6% and 3% annually, respectively, during these years.

Capital outlays are projected at levels to fund \$500,000 in capital outlays, equipment replacements out of the equipment replacement reserves, and items included in the Capital Improvements Program for the five year period ending June 30, 2022.

## WATER FUND 2016-2017 RESOURCES

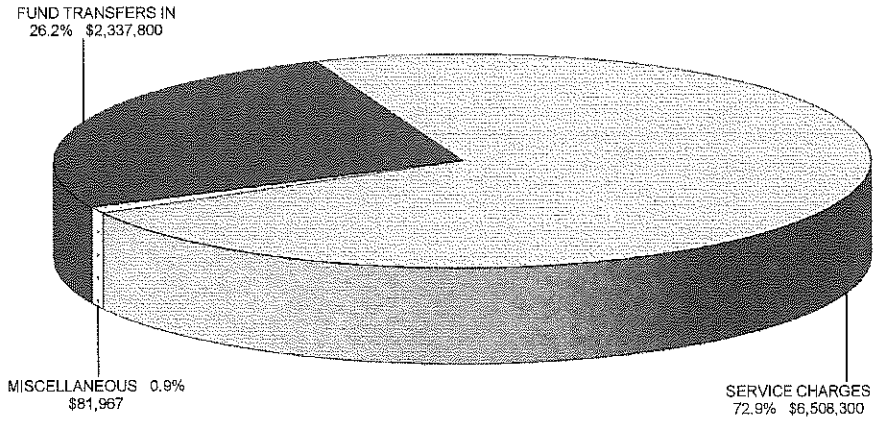

## WATER FUND 2016-2017 EXPENDITURES

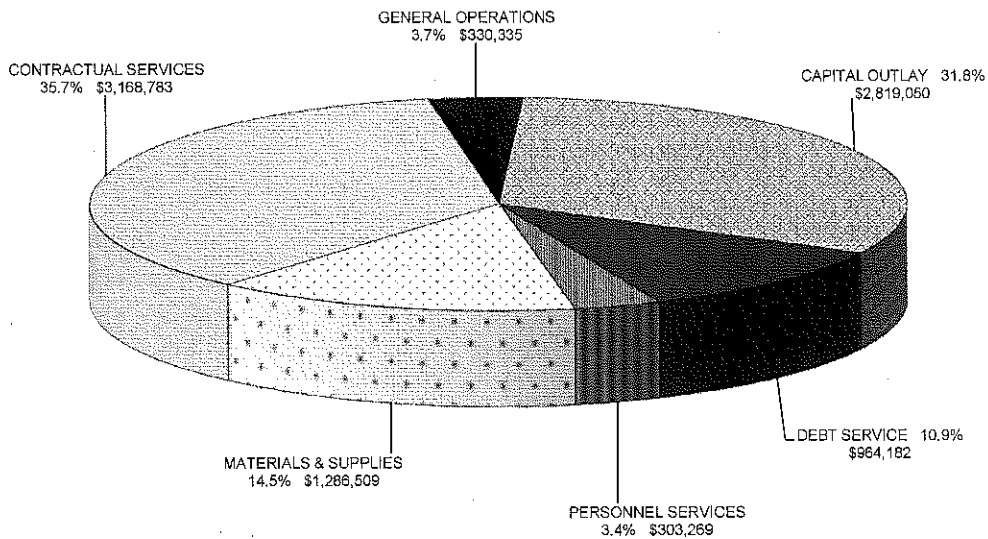

WATER FUND  
BUDGET BY MAJOR OBJECT

	2013-14 <u>ACTUAL</u>	2014-15 <u>ACTUAL</u>	2015-16 <u>BUDGET</u>	2016-17 <u>BUDGET</u>
REVENUE SOURCE:				
TAXES	\$ -	\$ -	\$ -	\$ -
LICENSES AND PERMITS	-	-	-	-
INTERGOVERN REVENUE	-	-	-	-
SERVICE CHARGES	6,362,839	6,123,265	6,449,285	6,508,300
FINES AND FORFEITS	-	-	-	-
MISCELLANEOUS	103,606	89,082	74,546	81,967
OTHER FINANCING	<u>964</u>	<u>14,225</u>	<u>55,724</u>	<u>-</u>
TOTAL REVENUE	\$ 6,467,409	\$ 6,226,572	\$ 6,579,555	\$ 6,590,267
EXPENSE OBJECT:				
PERSONNEL SERVICES	\$ 257,059	\$272,215	\$299,072	\$303,269
MATERIALS & SUPPLIES	1,004,229	1,012,949	1,184,864	1,286,509
CONTRACTUAL SERVICES	2,875,195	2,926,295	3,023,095	3,168,783
GENERAL OPERATIONS	328,164	316,699	338,380	330,335
CAPITAL OUTLAY	2,379,210	1,640,004	7,300,000	2,819,050
SPECIAL PROJECTS	235,075	242,311	250,000	-
DEBT SERVICE	<u>1,182,797</u>	<u>964,281</u>	<u>963,282</u>	<u>964,182</u>
TOTAL EXPENSES	\$ 8,261,729	\$ 7,374,755	\$ 13,358,693	\$ 8,872,128
FUND TRANSFERS IN	-	1,547,987	6,649,500	2,337,800
FUND TRANSFERS OUT	-	2,000	-	-
PROJECTED REVENUE OVER(UNDER) BUDGET			(946,362)	
PROJECTED EXPENDITURES UNDER(OVER) BUDGET			1,210,242	
RESERVED FUND BALANCE DECREASE(INCREASE)			(188,277)	(248,881)
EMERGENCY RESERVE FUND BALANCE DECREASE(INCREASE)				842
BEGINNING UNRESERVED FUND BALANCE			2,222,500	2,168,465
ENDING UNRESERVED FUND BALANCE			<u>2,168,465</u>	<u>1,976,365</u>
EMERGENCY RESERVE FUND		<u>908,804</u>	<u>908,804</u>	<u>907,962</u>

WATER FUND  
BUDGET PROJECTIONS

	<u>2017-18 PROJECTED</u>	<u>2017-18 PROJECTED</u>	<u>2019-20 PROJECTED</u>	<u>2020-21 PROJECTED</u>	<u>2021-22 PROJECTED</u>
REVENUE SOURCE:					
TAXES	\$ -	\$ -	\$ -	\$ -	\$ -
LICENSES AND PERMITS	-	-	-	-	-
INTERGOVERN REVENUE	-	-	-	-	-
SERVICE CHARGES	6,719,820	6,938,214	7,163,706	7,396,526	7,636,913
FINES AND FORFEITS	-	-	-	-	-
MISCELLANEOUS	90,230	79,082	77,962	78,206	79,848
OTHER FINANCING	-	-	-	-	-
<b>TOTAL REVENUE</b>	<b>\$6,810,050</b>	<b>\$7,017,296</b>	<b>\$7,241,668</b>	<b>\$7,474,732</b>	<b>\$7,716,761</b>
EXPENSE OBJECT:					
PERSONNEL SERVICES	\$ 309,372	\$ 316,555	\$ 323,970	\$ 331,629	\$ 339,543
MATERIALS & SUPPLIES	1,312,239	1,338,484	1,365,254	1,392,559	1,420,410
CONTRACTUAL SERVICES	3,232,159	3,296,802	3,362,738	3,429,993	3,498,593
GENERAL OPERATIONS	336,942	343,681	350,555	357,566	364,717
CAPITAL OUTLAY	772,184	780,350	788,761	797,424	806,347
SPECIAL PROJECTS	-	-	-	-	-
DEBT SERVICE	961,856	964,006	957,531	960,456	960,806
<b>TOTAL EXPENSES</b>	<b>\$6,924,752</b>	<b>\$7,039,878</b>	<b>\$7,148,809</b>	<b>\$7,269,627</b>	<b>\$7,390,416</b>
FUND TRANSFERS IN	-	-	-	-	-
FUND TRANSFERS OUT	-	-	-	-	-
PROJECTED REVENUE OVER(UNDER) BUDGET					
PROJECTED EXPENDITURES UNDER(OVER) BUDGET					
RESERVED FUND BALANCE DECREASE(INCREASE)	(121,327)	(125,270)	(129,341)	(133,545)	(137,885)
EMERGENCY RESERVE FUND BALANCE DECREASE(INCREASE)	(15,052)	(16,044)	(15,078)	(16,823)	(16,780)
BEGINNING UNRESERVED FUND BALANCE	1,977,351	1,726,270	1,562,374	1,510,813	1,565,550
ENDING UNRESERVED FUND BALANCE	<u>1,726,270</u>	<u>1,562,374</u>	<u>1,510,813</u>	<u>1,565,550</u>	<u>1,737,230</u>
EMERGENCY RESERVE FUND	<u>922,885</u>	<u>938,929</u>	<u>954,007</u>	<u>970,830</u>	<u>987,610</u>

WATER FUND REVENUE

	2013-14 <u>ACTUAL</u>	2014-15 <u>ACTUAL</u>	2015-16 <u>BUDGET</u>	2016-17 <u>PROPOSED</u>
Residential Water Usage	\$ 3,626,715	\$ 3,515,921	\$ 3,670,920	\$ 3,708,000
Commercial Water Usage	2,488,759	2,321,594	2,498,265	2,523,500
Water Tap Fee	82,814	122,872	120,000	112,500
Penalty	109,221	109,768	109,000	113,300
Residential Service Revenue	55,286	45,720	50,000	50,000
Commercial Service Revenue	45	7,390	1,100	1,000
	<u>6,362,839</u>	<u>6,123,265</u>	<u>6,449,285</u>	<u>6,508,300</u>
Interest on Overnight Investments	78,397	68,567	56,250	56,250
Interest on Special Assessment	131	103	79	-
Property rental	12,717	12,717	12,717	12,717
General Miscellaneous	12,361	7,695	5,500	13,000
	<u>103,606</u>	<u>89,082</u>	<u>74,546</u>	<u>81,967</u>
Special Assessment	725	1,744	724	-
Proceeds from Sale of Assets	240	-	-	-
Property Sale	-	12,481	55,000	-
	<u>964</u>	<u>14,225</u>	<u>55,724</u>	<u>-</u>
Transfers - General Fund	-	9,143	-	12,500
Transfers - Parks and Rec Fd	-	3,422	-	-
Transfer - Water Proj Sales Tax	-	1,532,000	6,649,500	2,325,300
Transfers In - Sewer	-	3,422	-	-
	<u>-</u>	<u>1,547,987</u>	<u>6,649,500</u>	<u>2,337,800</u>
	<u>\$6,467,409</u>	<u>\$7,774,559</u>	<u>\$13,229,055</u>	<u>\$8,928,067</u>

WATER (4060)

BUDGET BY MAJOR OBJECT

	2013-14 <u>ACTUAL</u>	2014-15 <u>ACTUAL</u>	2015-16 <u>BUDGET</u>	2016-17 <u>PROPOSED</u>
PERSONNEL COSTS	\$ 257,059	\$ 272,215	\$ 299,072	\$ 303,269
MATERIALS AND SUPPLIES	1,004,229	1,012,949	1,184,864	1,286,509
CONTRACTUAL SERVICES	2,875,195	2,926,295	3,023,095	3,168,783
GENERAL OPERATIONS	328,164	316,699	338,380	330,335
CAPITAL EXPENDITURES	2,379,210	1,640,004	7,300,000	2,819,050
SPECIAL PROJECTS	235,075	242,311	250,000	-
DEBT PAYMENTS	1,182,797	964,281	963,282	964,182
TRANSFERS	-	2,000	-	-
	<u>\$ 8,261,729</u>	<u>\$ 7,376,755</u>	<u>\$13,358,693</u>	<u>\$ 8,872,128</u>

TOTAL PERSONNEL SERVICE BY POSITION  
WATER

CLASSIFICATION	SALARY GRADE (Details in Appendices)		2015-2016 FISCAL YEAR	2016-2017 FISCAL YEAR
Regular Employees				
Public Works Director	Grade	V	0.20	0.20
Director of Citizens Services	Grade	U	0.10	0.10
Customer Serv. Manager	Grade	P	0.25	0.25
Foreman	Grade	L	1	1
Field Maintenance Mechanic	Grade	G	2	2
Senior Customer Service Rep.	Grade	G	0.40	0.40
Customer Serv. Reps.	Grade	F	1.7667	1.7667
TOTAL			5.7167	5.7167

---

THIS PAGE INTENTIONALLY LEFT BLANK

---

---

# **SOLID WASTE FUND**



---

## **SOLID WASTE FUND BUDGET HIGHLIGHTS**

### **REVENUE/RATE INCREASES**

Revenue is projected based on the estimated number of June 30, 2016 residential customers and transfer station tonnage projected for the fiscal year ending June 30, 2016. This budget assumes that the monthly residential rate increases to \$19.75 from \$19.25 with the first billing in July and that the transfer station tipping fee increases to \$59.00 per ton from \$57.50 per ton effective July 1. This budget assumes new revenue from Republic which includes an estimated transfer station usage fee of \$143,375 and lease revenue of \$60,000.

### **SIGNIFICANT OPERATING CHANGES**

Fleet maintenance costs are projected to be \$425,712 in this budget compared to \$391,452 in the current year's budget. Vehicle fuel costs are projected to be \$137,886 in this budget compared to \$171,302 in the current year's budget. This budget includes debt service of \$230,990 related to bonds issued to fund the new transfer station which begins operation in June 2016. There was no debt service included in the current year's budget for this expense.

### **CAPITAL IMPROVEMENT BUDGET AND EQUIPMENT REPLACEMENT**

This budget provides \$7,000 to remodel customer service's office space.

### **REVENUE/EXPENSE PROJECTIONS**

Revenue projections assume current usage levels and 3.50% rate increases for fees, excluding those charged to large transfer station users, for the following five years. Large transfer station users will pay rates that are \$7.75 per ton over the City's costs. Annual lease revenue is kept at \$60,000 for the five year projection period. Operating expenses, excluding the City's landfill disposal contract and personnel expenses are projected to grow at a 2% rate of inflation during these five years. The City's landfill disposal contract is projected to increase 3.0% annually. Personnel expenditures are projected to include wage increases equal to the inflation rate in the fiscal years after June 30, 2017 and an annual turnover rate of 5%. Costs for health and dental insurance are projected to grow 6% and 3% annually, respectively, during these years.

Capital outlays are projected at \$20,000 annually for the five year period ending June 30, 2022 plus annual replacements out of the equipment replacement reserves.

## SOLID WASTE FUND

### 2016-2017 RESOURCES

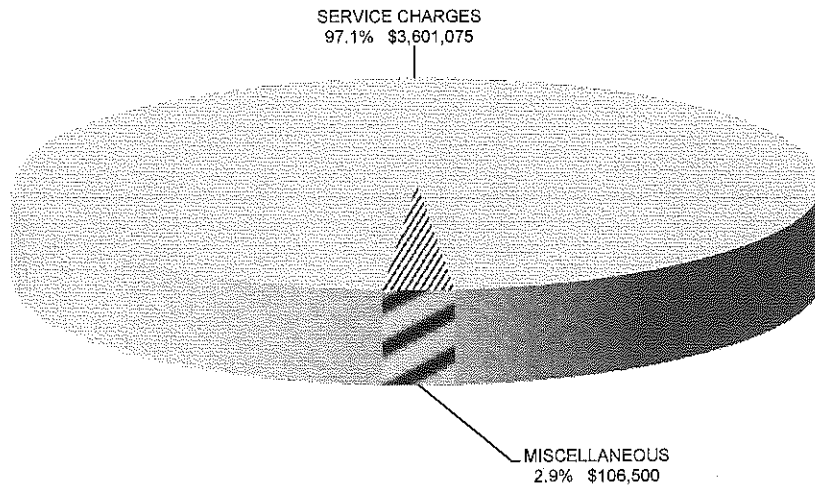

## SOLID WASTE FUND

### 2016-2017 EXPENDITURES

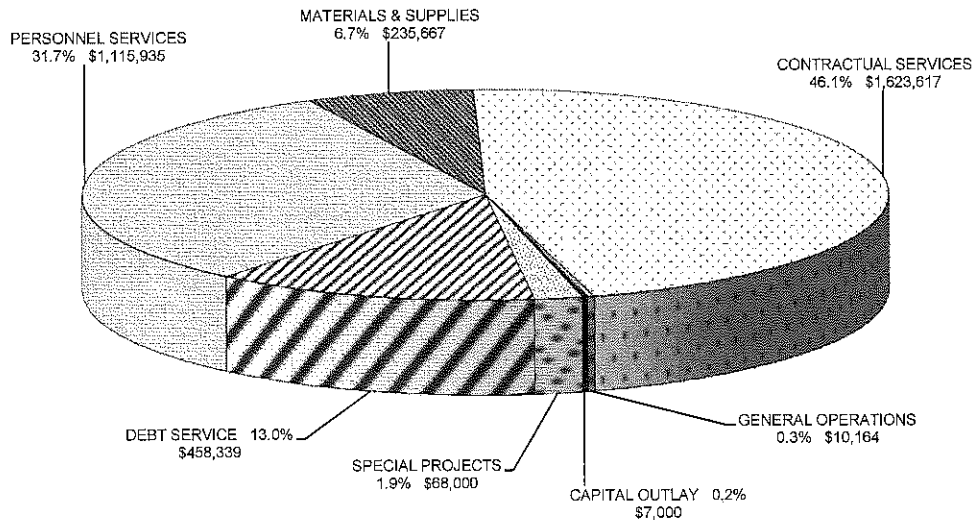

SOLID WASTE FUND  
BUDGET BY MAJOR OBJECT

	<u>2013-14</u> <u>ACTUAL</u>	<u>2014-15</u> <u>ACTUAL</u>	<u>2015-16</u> <u>BUDGET</u>	<u>2016-17</u> <u>BUDGET</u>
REVENUE SOURCE:				
TAXES	\$ -	\$ -	\$ -	\$ -
LICENSES AND PERMITS	-	-	-	-
INTERGOVERN REVENUE	-	-	-	-
SERVICE CHARGES	3,123,163	3,206,834	3,282,683	3,601,075
FINES AND FORFEITS	-	-	-	-
MISCELLANEOUS	53,861	54,962	48,000	106,500
OTHER FINANCING	<u>2,832</u>	<u>28,447</u>	<u>-</u>	<u>-</u>
TOTAL REVENUE	\$ 3,179,856	\$ 3,290,243	\$ 3,330,683	\$ 3,707,575
EXPENSE OBJECT:				
PERSONNEL SERVICES	\$1,111,604	\$1,121,942	\$1,145,580	\$1,115,935
MATERIALS & SUPPLIES	273,000	232,752	280,760	235,667
CONTRACTUAL SERVICES	1,578,474	1,465,500	1,498,113	1,623,617
GENERAL OPERATIONS	11,317	7,795	9,450	10,164
CAPITAL OUTLAY	36,107	356,415.06	3,000	7,000
SPECIAL PROJECTS	75,783	39,546	56,824	68,000
DEBT SERVICE	<u>254,033</u>	<u>1,223,820</u>	<u>222,872</u>	<u>458,339</u>
TOTAL EXPENSES	<u>\$3,340,318</u>	<u>\$4,447,770</u>	<u>\$3,216,599</u>	<u>\$3,518,722</u>
FUND TRANSFERS IN	-	993,153	-	-
FUND TRANSFERS OUT	-	-	-	-
PROJECTED REVENUE				
OVER(UNDER) BUDGET			4,402,388	
PROJECTED EXPENDITURES				
UNDER(OVER) BUDGET			(4,489,327)	
RESERVED FUND BALANCE				
DECREASE(INCREASE)			-	-
EMERGENCY RESERVE FUND BALANCE				
DECREASE(INCREASE)			(27,145)	(188,852)
BEGINNING UNRESERVED FUND				
BALANCE			-	-
ENDING UNRESERVED FUND				
BALANCE			<u>-</u>	<u>1</u>
EMERGENCY RESERVE FUND		<u>220,701</u>	<u>247,846</u>	<u>436,698</u>

SOLID WASTE FUND  
BUDGET PROJECTIONS

	2017-18 <u>PROJECTED</u>	2018-19 <u>PROJECTED</u>	2019-20 <u>PROJECTED</u>	2020-21 <u>PROJECTED</u>	2021-22 <u>PROJECTED</u>
REVENUE SOURCE:					
TAXES	\$ -	\$ -	\$ -	\$ -	\$ -
LICENSES AND PERMITS	-	-	-	-	-
INTERGOVERN REVENUE	-	-	-	-	-
SERVICE CHARGES	3,716,669	3,836,150	3,959,812	4,087,716	4,220,015
FINES AND FORFEITS	-	-	-	-	-
MISCELLANEOUS	108,236	112,449	114,674	117,982	122,315
OTHER FINANCING	-	-	-	-	-
<b>TOTAL REVENUE</b>	<b>\$3,824,905</b>	<b>\$3,948,599</b>	<b>\$4,074,486</b>	<b>\$4,205,698</b>	<b>\$4,342,330</b>
EXPENSE OBJECT:					
PERSONNEL SERVICES	\$ 1,143,011	\$ 1,171,013	\$ 1,199,987	\$ 1,229,978	\$ 1,261,034
MATERIALS & SUPPLIES	228,854	233,431	238,100	242,862	247,719
CONTRACTUAL SERVICES	1,665,609	1,708,529	1,752,743	1,798,108	1,844,670
GENERAL OPERATIONS	10,367	10,574	10,785	11,001	11,221
CAPITAL OUTLAY	158,315	162,464	166,738	171,140	175,674
SPECIAL PROJECTS	69,360	70,747	72,162	73,605	75,077
DEBT SERVICE	469,265	471,866	479,651	487,498	487,498
<b>TOTAL EXPENSES</b>	<b>\$3,744,781</b>	<b>\$3,828,624</b>	<b>\$3,920,166</b>	<b>\$4,014,192</b>	<b>\$4,102,893</b>
FUND TRANSFERS IN	-	-	-	-	-
FUND TRANSFERS OUT	-	-	-	-	-
PROJECTED REVENUE OVER(UNDER) BUDGET					
PROJECTED EXPENDITURES UNDER(OVER) BUDGET					
RESERVED FUND BALANCE DECREASE(INCREASE)	(96,775)	(25,538.00)	(105,791)	(178,062)	(226,813)
EMERGENCY RESERVE FUND BALANCE DECREASE(INCREASE)	16,650	(94,437)	(48,529)	(13,444)	(12,625)
BEGINNING UNRESERVED FUND BALANCE	1	-	-	-	-
ENDING UNRESERVED FUND BALANCE	-	-	-	-	-
<b>EMERGENCY RESERVE FUND</b>	<b>420,048</b>	<b>514,485</b>	<b>563,014</b>	<b>576,458</b>	<b>589,083</b>

---

THIS PAGE INTENTIONALLY LEFT BLANK

---

SOLID WASTE FUND REVENUE

	2013-14 <u>ACTUAL</u>	2014-15 <u>ACTUAL</u>	2015-16 <u>BUDGET</u>	2016-17 <u>PROPOSED</u>
Penalty	\$ 63,738	\$ 66,106	\$ 67,500	\$ 61,550
City Collection	37,076	38,624	38,000	39,500
Residential Collection	2,409,891	2,366,497	2,440,600	2,521,850
Commercial Collection	-	17	-	-
Transfer Station Fees	582,156	704,585	705,083	968,675
Special Wednesday Pickup	7,548	8,279	8,000	9,500
Special Lugger Service	22,729	22,701	23,500	-
Residential-Other	<u>25</u>	<u>25</u>	<u>-</u>	<u>-</u>
	3,123,163	3,206,834	3,282,683	3,601,075
Interest on Overnight Investment:	11,009	9,627	5,000	5,000
General Miscellaneous	5,195	5,040	3,000	5,000
Recycling Revenue	37,658	40,295	40,000	36,500
Building Lease	-	-	-	60,000
Cash Overages & Shortages	<u>(1)</u>	<u>(0)</u>	<u>-</u>	<u>-</u>
	53,861	54,962	48,000	106,500
Proceeds from Sale of Assets	2,832	-	-	-
Property sale (Proprietary)	-	4,447	-	-
Proceeds from Trade-in of Assets	<u>-</u>	<u>24,000</u>	<u>-</u>	<u>-</u>
	2,832	28,447	-	-
Transfer - General Fund	-	504,818	-	-
LT advance from other city fd	<u>-</u>	<u>488,335</u>	<u>-</u>	<u>-</u>
	-	993,153	-	-
	<u>\$3,179,856</u>	<u>\$4,283,396</u>	<u>\$3,330,683</u>	<u>\$3,707,575</u>

## Transfer Station

The transfer station is the disposal point of solid waste materials. This facility also receives waste materials from numerous residential, commercial, and industrial facilities throughout the county. The station prepares waste material for shipment to the sanitary landfill facility in Dexter, MO

### 2016-2017 Proposed Budget

#### Solid Waste Fund

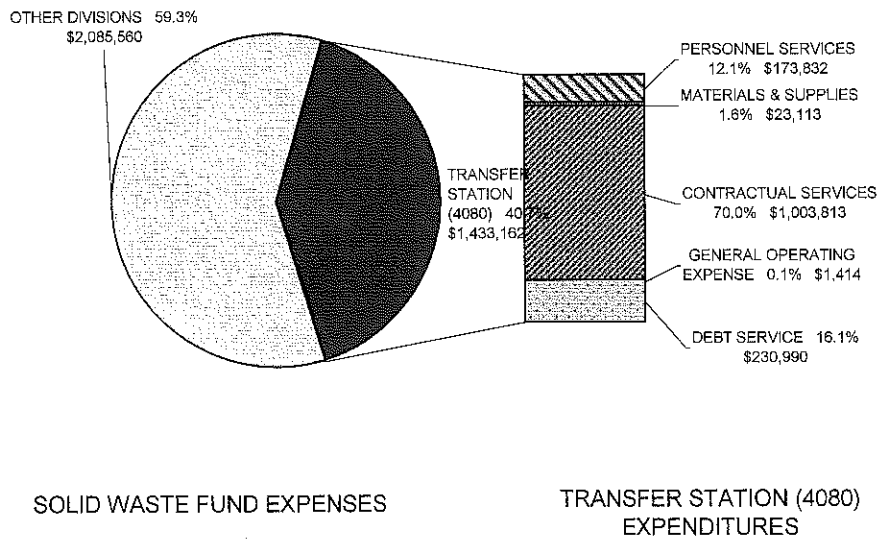

TRANSFER STATION (4080)

BUDGET BY MAJOR OBJECT

	2013-14 <u>ACTUAL</u>	2014-15 <u>ACTUAL</u>	2015-16 <u>BUDGET</u>	2016-17 <u>PROPOSED</u>
PERSONNEL COSTS	\$ 158,822	\$168,349	\$179,244	\$173,832
MATERIALS AND SUPPLIES	24,026	20,364	48,510	23,113
CONTRACTUAL SERVICES	936,810	902,241	921,043	1,003,813
GENERAL OPERATIONS	2,076	1,215	1,200	1,414
CAPITAL EXPENDITURES	-	213,217	3,000	-
SPECIAL PROJECTS	-	-	-	-
DEBT PAYMENTS	-	-	-	230,990
TRANSFERS	-	-	-	-
	<u>\$1,121,734</u>	<u>\$1,305,386</u>	<u>\$1,152,997</u>	<u>\$1,433,162</u>

TOTAL PERSONNEL SERVICE BY POSITION  
TRANSFER STATION

CLASSIFICATION	SALARY GRADE (Details in Appendices)		2015-2016 FISCAL YEAR	2016-2017 FISCAL YEAR
Regular Employees				
Assistant Public Works Director	Grade	U	0.125	0.125
Transfer Station Chief Operator	Grade	K	1	1
Administrative Technician	Grade	G	0.25	0.25
Transfer Station Operator	Grade	C	<u>2</u>	<u>2</u>
TOTAL			3.375	3.375



## Residential Solid Waste

The residential division collects and disposes of solid waste materials generated by citizens, as well as provides for special pick-up services for items and materials excluded in scheduled daily collection.

## 2016-2017 Proposed Budget Solid Waste Fund

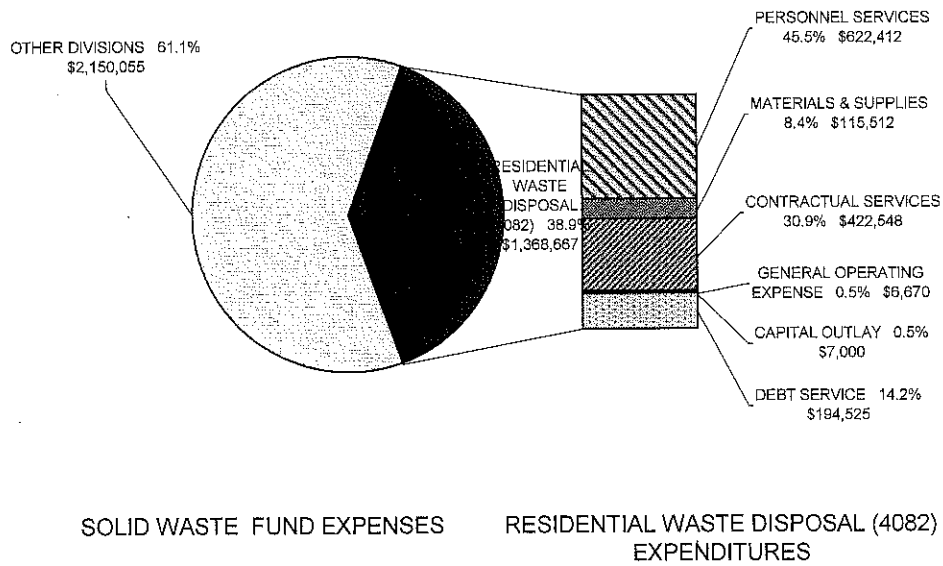

RESIDENTIAL WASTE DISPOSAL (4082)

BUDGET BY MAJOR OBJECT

	2013-14 <u>ACTUAL</u>	2014-15 <u>ACTUAL</u>	2015-16 <u>BUDGET</u>	2016-17 <u>PROPOSED</u>
PERSONNEL COSTS	\$672,961	\$643,618	\$648,638	\$622,412
MATERIALS AND SUPPLIES	141,422	122,597	131,482	115,512
CONTRACTUAL SERVICES	409,814	408,382	383,291	422,548
GENERAL OPERATIONS	6,658	4,588	6,170	6,670
CAPITAL EXPENDITURES	36,107	143,199	-	7,000
SPECIAL PROJECTS	-	-	-	-
DEBT PAYMENTS	182,605	269,583	200,105	194,525
TRANSFERS	-	-	-	-
	<u>\$1,449,567</u>	<u>1,591,967</u>	<u>\$1,369,686</u>	<u>\$1,368,667</u>

TOTAL PERSONNEL SERVICE BY POSITION  
RESIDENTIAL WASTE DISPOSAL

CLASSIFICATION	SALARY GRADE (Details in Appendices)	2015-2016 FISCAL YEAR	2016-2017 FISCAL YEAR
Regular Employees			
Public Works Director	Grade V	0.20	0.20
Director of Citizens Services	Grade U	0.10	0.10
Assistant Public Works Director	Grade U	0.25	0.25
Solid Waste Superintendent	Grade Q	1	1
Fleet Manager	Grade O	0.25	0.25
Customer Service Manager	Grade P	0.25	0.25
Solid Waste Crew Leader	Grade L	1	1
PW System/GIS Analyst	Grade L	0.125	0.125
Senior Solid Waste Driver	Grade I	1	1
Senior Customer Service Rep.	Grade G	0.30	0.30
Solid Waste Driver	Grade G	2	2
Administrative Technician	Grade G	0.25	0.25
Customer Service Rep.	Grade F	1.3667	1.3667
Administrative Secretary	Grade E	1	1
Solid Waste Worker II	Grade C	4	3
TOTAL		13.0917	12.0917

## Landfill

The landfill which has served as a back-up disposal facility in the past is now closed. The City is required by state and federal laws and regulations to place a final cover on the landfill and perform monitoring functions for thirty years after closure. The proposed budget provides for postclosure maintenance and monitoring of the landfill for the 2002-2003 fiscal year.

## 2016-2017 Proposed Budget Solid Waste Fund

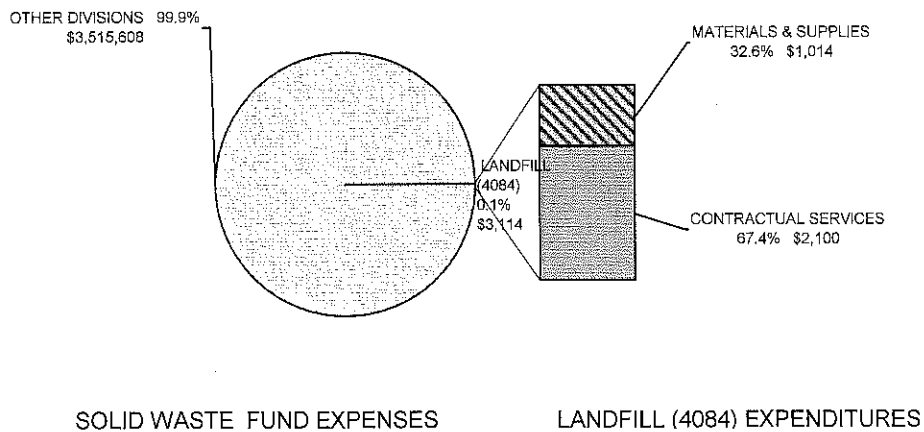

LANDFILL (4084)

BUDGET BY MAJOR OBJECT

	2013-14 <u>ACTUAL</u>	2014-15 <u>ACTUAL</u>	2015-16 <u>BUDGET</u>	2016-17 <u>PROPOSED</u>
PERSONNEL COSTS	\$ 1,232	\$ 616	\$ -	\$ -
MATERIALS AND SUPPLIES	1,871	421	1,025	1,014
CONTRACTUAL SERVICES	1,402	870	2,100	2,100
GENERAL OPERATIONS	-	-	-	-
CAPITAL EXPENDITURES	-	-	-	-
SPECIAL PROJECTS	-	-	-	-
DEBT PAYMENTS	-	-	-	-
TRANSFERS	-	-	-	-
	<u>\$ 4,505</u>	<u>\$ 1,907</u>	<u>\$ 3,125</u>	<u>\$ 3,114</u>

## Recycling

The recycling division accounts for the collection and processing cost of handling all recyclable materials. Materials are collected on weekly routes and are received at the Recycling Center.

## 2016-2017 Proposed Budget

### Solid Waste Fund

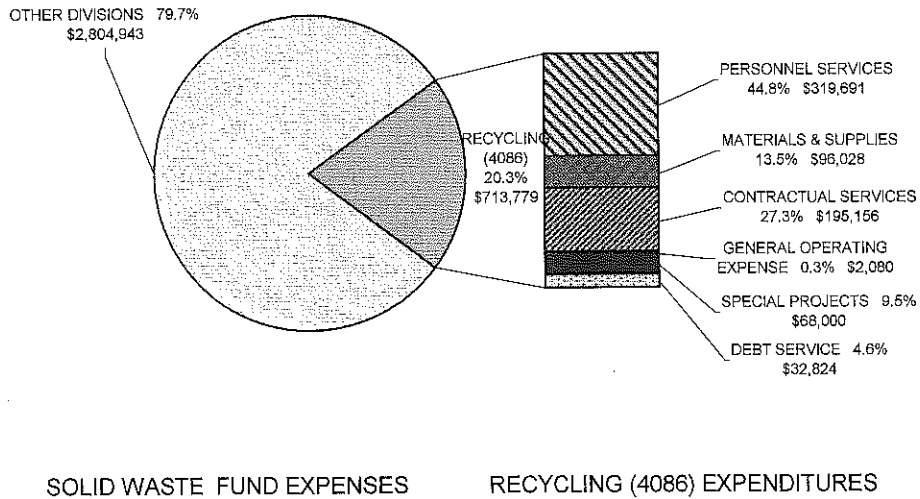

SOLID WASTE FUND EXPENSES

RECYCLING (4086) EXPENDITURES

RECYCLING (4086)

BUDGET BY MAJOR OBJECT

	2013-14 <u>ACTUAL</u>	2014-15 <u>ACTUAL</u>	2015-16 <u>BUDGET</u>	2016-17 <u>PROPOSED</u>
PERSONNEL COSTS	\$278,589	\$309,360	\$317,698	\$319,691
MATERIALS AND SUPPLIES	105,681	89,370	99,743	96,028
CONTRACTUAL SERVICES	230,448	154,006	191,679	195,156
GENERAL OPERATIONS	2,583	1,992	2,080	2,080
CAPITAL EXPENDITURES	-	-	-	-
SPECIAL PROJECTS	75,783	39,546	56,824	68,000
DEBT PAYMENTS	71,428	954,237	22,767	32,824
TRANSFERS	-	-	-	-
	<u>\$764,512</u>	<u>\$1,548,510</u>	<u>\$690,791</u>	<u>\$713,779</u>

TOTAL PERSONNEL SERVICE BY POSITION  
RECYCLING

CLASSIFICATION	SALARY GRADE (Details in Appendices)	2015-2016 FISCAL YEAR	2016-2017 FISCAL YEAR
Regular Employees			
Fleet Manager	Grade O	0.25	0.25
Recycling Crew Leader	Grade L	1	1
PW System/GIS Analyst	Grade L	0.125	0.125
Administrative Specialist	Grade G	1	1
Solid Waste Driver	Grade G	3	3
Administrative Technician	Grade G	0.25	0.25
Solid Waste Worker II	Grade C	1	1
TOTAL		6.625	6.625

---

THIS PAGE INTENTIONALLY LEFT BLANK

---

---

# **GOLF COURSE FUND**



---

## **GOLF COURSE FUND** **BUDGET HIGHLIGHTS**

### **REVENUE/RATE INCREASES**

This budget proposes no fee increases. As new activities arise during the year, user fees may be charged to offset operating costs.

### **SIGNIFICANT OPERATING CHANGES**

This budget includes no significant operating changes.

### **CAPITAL OUTLAYS**

This budget includes nothing for capital expenditures.

### **REVENUE/EXPENSE PROJECTIONS**

Revenue projections assume projected 2015 – 2016 usage levels for the 5-year period and annual 3.0% rate increases. Transfers from the Parks/Storm Water Sales Tax – Operations Fund are required at levels of \$59,620 declining to \$45,779 during this time frame to maintain level fund balances. Projected revenues do not support any capital expenditures.

Operating expenses, excluding personnel expenses are also projected to grow at a 2% rate of inflation. Personnel expenditures are projected to include wage increases equal to the inflation rate in the fiscal years after June 30, 2017 and an annual turnover rate of 5%. Costs for health and dental insurance are projected to grow 6% and 3% annually, respectively, during these years.

## GOLF COURSE FUND 2016-2017 RESOURCES

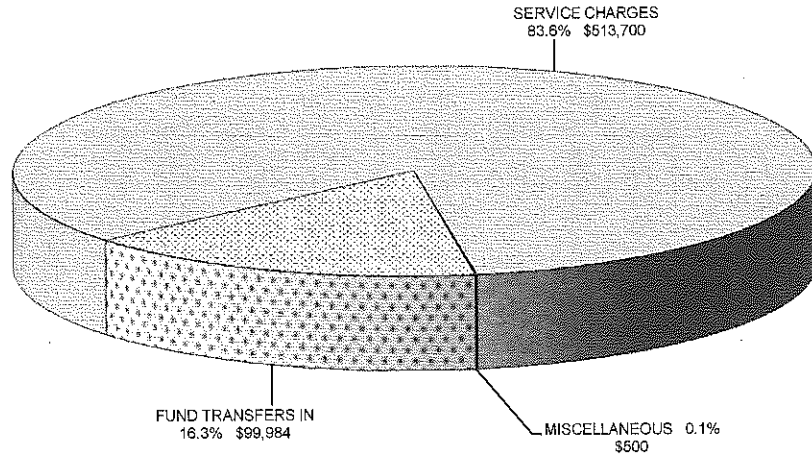

## GOLF COURSE FUND 2016-2017 EXPENDITURES

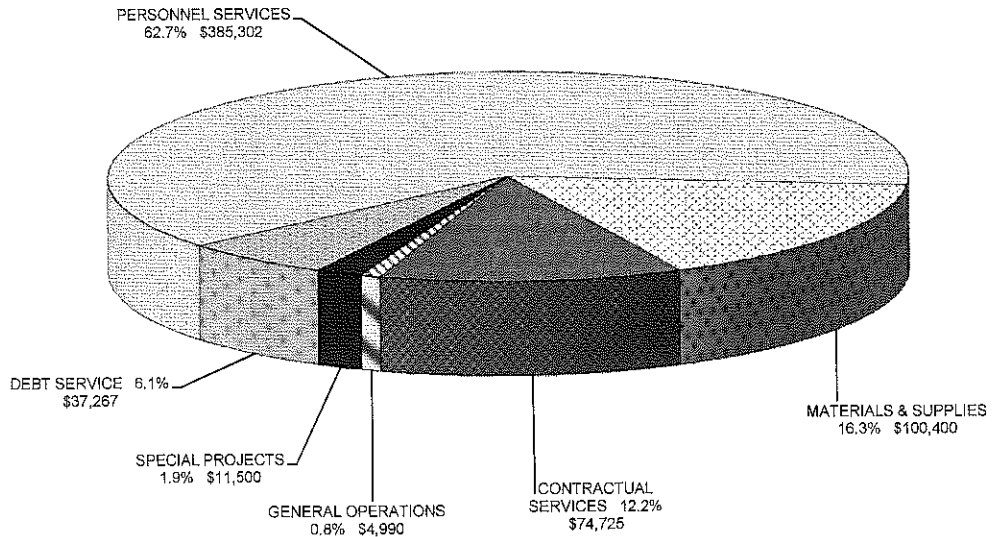

GOLF COURSE FUND  
BUDGET BY MAJOR OBJECT

	<u>2013-14</u> <u>ACTUAL</u>	<u>2014-15</u> <u>ACTUAL</u>	<u>2015-16</u> <u>BUDGET</u>	<u>2016-17</u> <u>BUDGET</u>
REVENUE SOURCE:				
TAXES	\$ -	\$ -	\$ -	\$ -
LICENSES AND PERMITS	-	-	-	-
INTERGOVERN REVENUE	-	-	-	-
SERVICE CHARGES	477,171	497,849	533,806	513,700
FINES AND FORFEITS	-	-	-	-
MISCELLANEOUS	3,764	2,844	500	500
OTHER FINANCING	<u>7,210</u>	<u>1,133</u>	<u>-</u>	<u>-</u>
TOTAL REVENUE	\$ 488,145	\$ 501,826	\$ 534,306	\$ 514,200
EXPENSE OBJECT:				
PERSONNEL SERVICES	\$400,290	\$359,036	\$375,916	\$385,302
MATERIALS & SUPPLIES	100,951	110,489	118,027	100,400
CONTRACTUAL SERVICES	97,169	73,950	77,174	74,725
GENERAL OPERATIONS	8,932	156	11,290	4,990
CAPITAL OUTLAY	-	-	-	-
SPECIAL PROJECTS	6,467	4,634	7,500	11,500
DEBT SERVICE	<u>37,267</u>	<u>37,267</u>	<u>37,267</u>	<u>37,267</u>
TOTAL EXPENSES	<u>\$651,075</u>	<u>\$585,531</u>	<u>\$627,174</u>	<u>\$614,184</u>
FUND TRANSFERS IN	154,726	106,509	92,868	99,984
FUND TRANSFERS OUT	-	-	-	-
PROJECTED REVENUE OVER(UNDER) BUDGET			25,000	
PROJECTED EXPENDITURES UNDER(OVER) BUDGET			837	
RESERVED FUND BALANCE DECREASE(INCREASE)				
EMERGENCY RESERVE FUND BALANCE DECREASE(INCREASE)				
BEGINNING UNRESERVED FUND BALANCE			(25,837)	-
ENDING UNRESERVED FUND BALANCE			<u>-</u>	<u>-</u>
EMERGENCY RESERVE FUND			<u>-</u>	<u>-</u>

GOLF COURSE FUND  
BUDGET PROJECTIONS

	2017-18 <u>PROJECTED</u>	2018-19 <u>PROJECTED</u>	2019-20 <u>PROJECTED</u>	2020-21 <u>PROJECTED</u>	2021-22 <u>PROJECTED</u>
REVENUE SOURCE:					
TAXES	\$ -	\$ -	\$ -	\$ -	\$ -
LICENSES AND PERMITS	-	-	-	-	-
INTERGOVERN REVENUE	-	-	-	-	-
SERVICE CHARGES	529,111	544,984	561,334	578,174	595,519
FINES AND FORFEITS	-	-	-	-	-
MISCELLANEOUS	500	500	500	500	500
OTHER FINANCING	-	-	-	-	-
<b>TOTAL REVENUE</b>	<b>\$529,611</b>	<b>\$545,484</b>	<b>\$561,834</b>	<b>\$578,674</b>	<b>\$596,019</b>
EXPENSE OBJECT:					
PERSONNEL SERVICES	\$ 393,783	\$ 402,508	\$ 411,485	\$ 420,725	\$ 430,238
MATERIALS & SUPPLIES	102,408	104,456	106,545	108,676	110,850
CONTRACTUAL SERVICES	76,220	77,744	79,299	80,885	82,503
GENERAL OPERATIONS	5,090	5,192	5,296	5,402	5,510
CAPITAL OUTLAY	-	-	-	-	-
SPECIAL PROJECTS	11,730	11,965	12,204	12,448	12,697
DEBT SERVICE	-	-	-	-	-
<b>TOTAL EXPENSES</b>	<b>\$589,231</b>	<b>\$601,865</b>	<b>\$614,829</b>	<b>\$628,136</b>	<b>\$641,798</b>
FUND TRANSFERS IN	59,620	56,381	52,995	49,462	45,779
FUND TRANSFERS OUT	-	-	-	-	-
PROJECTED REVENUE OVER(UNDER) BUDGET					
PROJECTED EXPENDITURES UNDER(OVER) BUDGET					
RESERVED FUND BALANCE DECREASE(INCREASE)					
EMERGENCY RESERVE FUND BALANCE DECREASE(INCREASE)					
BEGINNING UNRESERVED FUND BALANCE	-	-	-	-	-
ENDING UNRESERVED FUND BALANCE	-	-	-	-	-
EMERGENCY RESERVE FUND	-	-	-	-	-

---

THIS PAGE INTENTIONALLY LEFT BLANK

---

GOLF COURSE FUND REVENUE

	2013-14 <u>ACTUAL</u>	2014-15 <u>ACTUAL</u>	2015-16 <u>BUDGET</u>	2016-17 <u>PROPOSED</u>
Pro Shop Concessions	\$ 28,062	\$ 26,667	\$ 30,000	\$ 30,000
Pro Shop Concessions-Beer	48,002	45,902	50,000	50,000
Cost of Items Resold	(63,393)	(27,215)	(57,900)	(60,300)
Green Fees - Weekend	99,196	86,726	112,780	104,000
Green Fees - Weekly	122,495	124,069	142,826	135,000
Private-Cart Fees	5,624	3,700	7,000	4,000
Motor-Cart Fees	155,552	154,980	163,000	160,000
Other Equipment Rental	934	884	1,200	1,200
Equipment Sales	14,782	12,520	16,500	18,500
Annual Pass Fees	51,529	57,554	55,000	55,000
Golf Class Fees	188	1,382	400	800
Tournament Fees	<u>14,200</u>	<u>10,680</u>	<u>13,000</u>	<u>15,500</u>
	477,171	497,849	533,806	513,700
Interest on Overnight Investment:	562	480	500	500
Donations	3,210	1,020	-	-
Cash Overages & Shortages	(8)	(83)	-	-
General Miscellaneous	<u>0</u>	<u>1,426</u>	<u>-</u>	<u>-</u>
	3,764	2,844	500	500
Proceeds from Sale of Asset	<u>7,210</u>	<u>1,133</u>	<u>-</u>	<u>-</u>
	7,210	1,133	-	-
Transfers In-Park/Stormwater -Operating	154,726	104,509	92,868	99,984
Transfers In-Water Fund	<u>-</u>	<u>2,000</u>	<u>-</u>	<u>-</u>
	154,726	106,509	92,868	99,984
	<u>\$642,871</u>	<u>\$608,335</u>	<u>\$627,174</u>	<u>\$614,184</u>

## Golf Operations

This division provides for the operation and maintenance of the 18 hole municipal golf course.

## 2016-2017 Proposed Budget Golf Fund

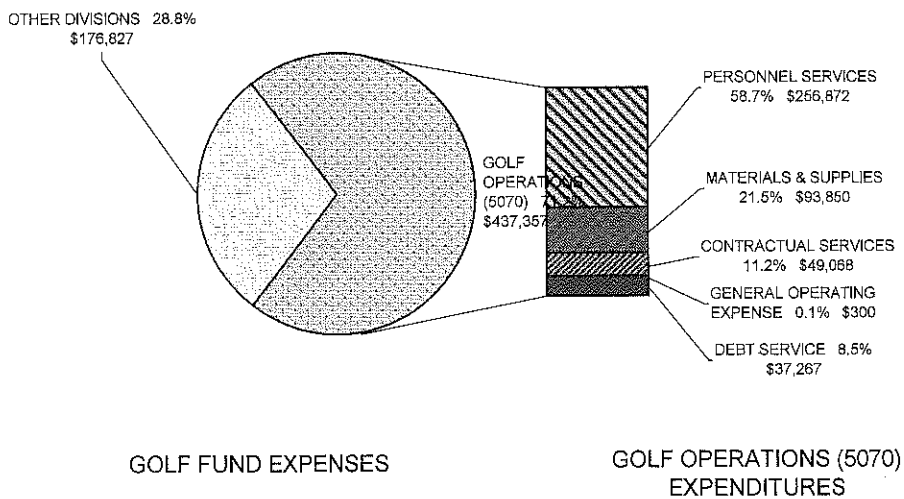

GOLF OPERATIONS (5070)

BUDGET BY MAJOR OBJECT

	2013-14 <u>ACTUAL</u>	2014-15 <u>ACTUAL</u>	2015-16 <u>BUDGET</u>	2016-17 <u>PROPOSED</u>
PERSONNEL COSTS	\$275,372	\$241,872	\$250,007	\$256,872
MATERIALS AND SUPPLIES	95,270	101,909	99,127	93,850
CONTRACTUAL SERVICES	84,526	51,922	60,199	49,068
GENERAL OPERATIONS	189	-	300	300
CAPITAL EXPENDITURES	-	-	-	-
SPECIAL PROJECTS	-	-	-	-
DEBT PAYMENTS	37,267	37,267	37,267	37,267
TRANSFERS	-	-	-	-
	<u>\$492,623</u>	<u>\$432,970</u>	<u>\$446,900</u>	<u>\$437,357</u>

TOTAL PERSONNEL SERVICE BY POSITION  
GOLF OPERATIONS

CLASSIFICATION	SALARY GRADE	2015-2016 FISCAL YEAR	2016-2017 FISCAL YEAR
Regular Employees			
Golf Course Supervisor	Grade M	1	1
Senior Maintenance Worker	Grade I	1	1
Maintenance Worker II	Grade G	<u>2</u>	<u>2</u>
TOTAL		4	4

Part-Time Employees

	2015-2016		2016-2017	
	<u>Actual Hours</u>	<u>Full-Time Equivalent</u>	<u>Actual Hours</u>	<u>Full-Time Equivalent</u>
Greenskeepers	<u>4,080</u>	<u>1.96</u>	<u>4,080</u>	<u>1.96</u>
	4,080	1.96	4,080	1.96



## Golf Pro Shop

This division provides for the operation of the golf pro shop which provides services such as concessions, equipment rental, and marshalling of the course.

## 2016-2017 Proposed Budget

### Golf Fund

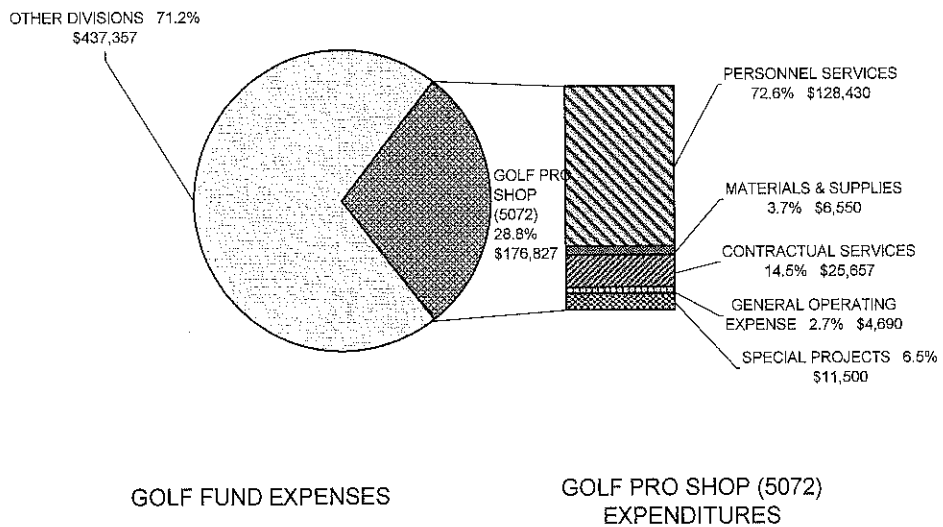

GOLF PRO SHOP (5072)

BUDGET BY MAJOR OBJECT

	2013-14 <u>ACTUAL</u>	2014-15 <u>ACTUAL</u>	2015-16 <u>BUDGET</u>	2016-17 <u>PROPOSED</u>
PERSONNEL COSTS	\$124,918	\$117,164	\$125,909	\$128,430
MATERIALS AND SUPPLIES	5,680	8,579	18,900	6,550
CONTRACTUAL SERVICES	12,643	22,028	16,975	25,657
GENERAL OPERATIONS	8,743	156	10,990	4,690
CAPITAL EXPENDITURES	-	-	-	-
SPECIAL PROJECTS	6,467	4,634	7,500	11,500
DEBT PAYMENTS	-	-	-	-
TRANSFERS	-	-	-	-
	<u>\$158,452</u>	<u>\$152,561</u>	<u>\$180,274</u>	<u>\$176,827</u>

TOTAL PERSONNEL SERVICE BY POSITION  
GOLF PRO SHOP

CLASSIFICATION	SALARY GRADE (Details in Appendices)		2015-2016 FISCAL YEAR	2016-2017 FISCAL YEAR
Regular Employees				
Facility Supervisor	Grade	N	1	1
Part-Time Employees				
	2015-2016		2016-2017	
	<u>Actual Number</u>	<u>Full-Time Equivalent</u>	<u>Actual Number</u>	<u>Full-Time Equivalent</u>
Pro Shop Asst. Manager	2,204	1.06	2,204	1.06
Instructors	20	0.01	20	0.01
Marshalls, Concession Workers	<u>6,064</u>	<u>2.92</u>	<u>6,306</u>	<u>3.03</u>
	8,288	3.98	8,530	4.10

---

THIS PAGE INTENTIONALLY LEFT BLANK

---

---

# **SPORTS COMPLEXES FUND**

---

**SPORTS COMPLEXES FUND**  
**BUDGET HIGHLIGHTS**

**ACTIVITIES**

The Sports Complexes Fund provides for the operation and maintenance of all of the athletic fields throughout the city and the operation of concession stands for league and tournament events.

**REVENUE/RATE INCREASES**

No fee increases are proposed by this budget. As new activities arise during the year, user fees may be charged to offset operating costs.

**SIGNIFICANT OPERATING CHANGES**

A new recreation coordinator position will be shared with the recreation division. Applicable costs to this fund are \$24,113. This cost will be partially offset by the reduction of 400 hours for part-time concession managers which saves approximately \$4,428.

**CAPITAL OUTLAYS**

This budget includes \$7,500 to replace an air conditioning unit at one of its concession buildings.

**REVENUE/EXPENSE PROJECTIONS**

Revenue projections assume user fees growing 3% annually. Transfers from the General Fund and from the Parks/Storm Water Sales Tax – Operations Fund are required to grow from \$642,635 to \$658,650 during this time frame to maintain level fund balances and repay the advance from the General Fund.

Operating expenses, excluding personnel expenses are also projected to grow at a 2% rate of inflation. Personnel expenditures are projected to include wage increases equal to the inflation rate in the fiscal years after June 30, 2017 and an annual turnover rate of 5%. Costs for health and dental insurance are projected to grow 6% and 3% annually, respectively, during these years. No capital outlays are projected since any capital outlays would be supported by General Fund transfers

## SPORTS COMPLEXES 2016-2017 RESOURCES

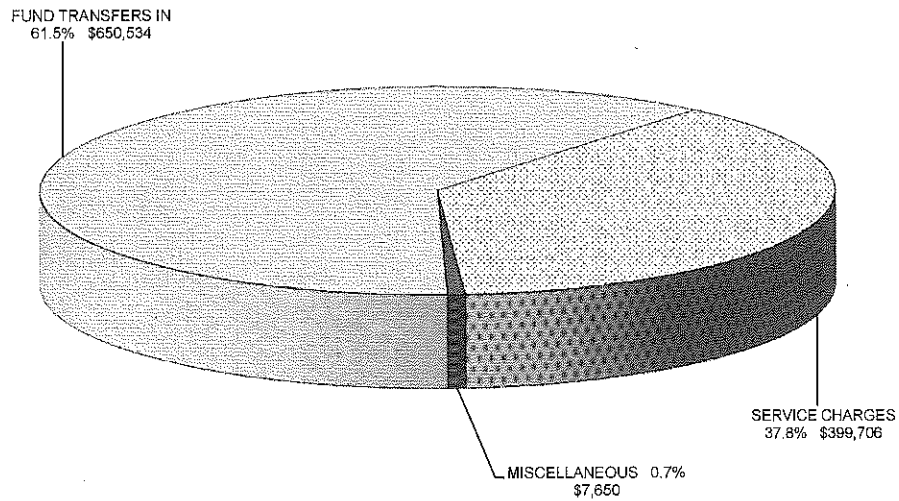

## SPORTS COMPLEXES 2016-2017 EXPENDITURES

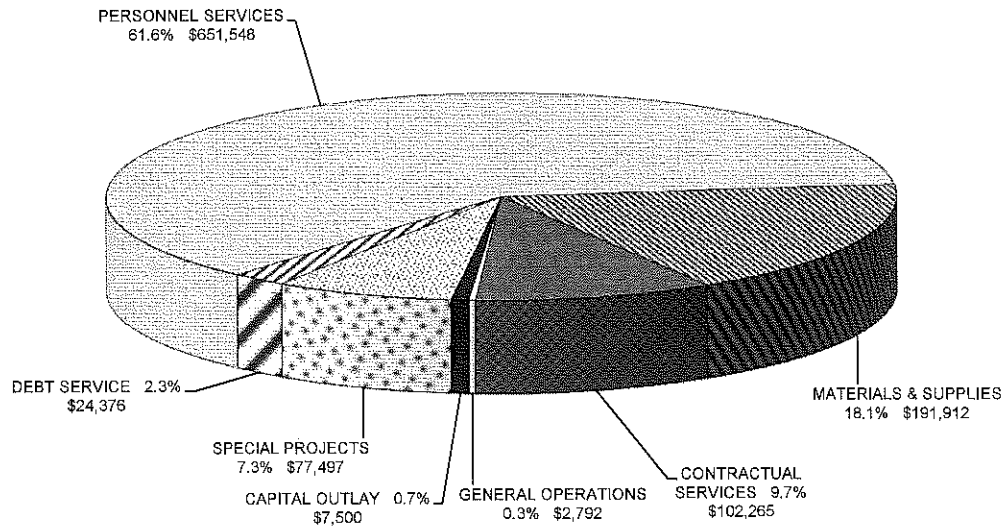

SPORTS COMPLEXES  
BUDGET BY MAJOR OBJECT

	<u>2013-14</u> <u>ACTUAL</u>	<u>2014-15</u> <u>ACTUAL</u>	<u>2015-16</u> <u>BUDGET</u>	<u>2016-17</u> <u>BUDGET</u>
REVENUE SOURCE:				
TAXES	\$ -	\$ -	\$ -	\$ -
LICENSES AND PERMITS	-	-	-	-
INTERGOVERN REVENUE	-	-	-	-
SERVICE CHARGES	360,842	440,572	413,909	399,706
FINES AND FORFEITS	-	-	-	-
MISCELLANEOUS	752	686	11,800	7,650
OTHER FINANCING	-	4,718	-	-
	-	4,718	-	-
TOTAL REVENUE	\$ 361,594	\$ 445,976	\$ 425,709	\$ 407,356
EXPENSE OBJECT:				
PERSONNEL SERVICES	\$611,721	\$608,767	\$623,480	\$651,548
MATERIALS & SUPPLIES	161,143	171,458	196,990	191,912
CONTRACTUAL SERVICES	103,932	80,559	77,457	102,265
GENERAL OPERATIONS	3,759	1,005	3,232	2,792
CAPITAL OUTLAY	-	-	-	7,500
SPECIAL PROJECTS	72,112	79,677	75,110	77,497
DEBT SERVICE	24,376	24,376	24,376	24,376
	24,376	24,376	24,376	24,376
TOTAL EXPENSES	\$977,043	\$965,842	\$1,000,645	\$1,057,890
FUND TRANSFERS IN	626,533	623,695	574,936	650,534
FUND TRANSFERS OUT	-	-	-	-
PROJECTED REVENUE OVER(UNDER) BUDGET			(22,511)	
PROJECTED EXPENDITURES UNDER(OVER) BUDGET			(18,603)	
RESERVED FUND BALANCE DECREASE(INCREASE)				
EMERGENCY RESERVE FUND BALANCE DECREASE(INCREASE)				
BEGINNING UNRESERVED FUND BALANCE			41,114	-
ENDING UNRESERVED FUND BALANCE			-	-
EMERGENCY RESERVE FUND			-	-

SPORTS COMPLEXES  
BUDGET PROJECTIONS

	2017-18 <u>PROJECTED</u>	2018-19 <u>PROJECTED</u>	2019-20 <u>PROJECTED</u>	2020-21 <u>PROJECTED</u>	2021-22 <u>PROJECTED</u>
REVENUE SOURCE:					
TAXES	\$ -	\$ -	\$ -	\$ -	\$ -
LICENSES AND PERMITS	-	-	-	-	-
INTERGOVERN REVENUE	-	-	-	-	-
SERVICE CHARGES	411,697	424,048	436,770	449,873	463,369
FINES AND FORFEITS	-	-	-	-	-
MISCELLANEOUS	7,650	7,650	7,650	7,650	7,650
OTHER FINANCING	-	-	-	-	-
<b>TOTAL REVENUE</b>	<b>\$419,347</b>	<b>\$431,698</b>	<b>\$444,420</b>	<b>\$457,523</b>	<b>\$471,019</b>
EXPENSE OBJECT:					
PERSONNEL SERVICES	\$ 665,851	\$ 680,559	\$ 695,686	\$ 711,250	\$ 727,268
MATERIALS & SUPPLIES	185,550	189,261	193,046	196,907	200,845
CONTRACTUAL SERVICES	104,310	106,397	108,524	110,695	112,909
GENERAL OPERATIONS	2,848	2,905	2,963	3,022	3,083
CAPITAL OUTLAY	-	-	-	-	-
SPECIAL PROJECTS	79,047	80,628	82,241	83,886	85,564
DEBT SERVICE	24,376	0	-	-	-
<b>TOTAL EXPENSES</b>	<b>\$1,061,982</b>	<b>\$1,059,750</b>	<b>\$1,082,460</b>	<b>\$1,105,760</b>	<b>\$1,129,669</b>
FUND TRANSFERS IN	642,635	628,052	638,040	648,237	658,650
FUND TRANSFERS OUT	-	-	-	-	-
PROJECTED REVENUE OVER(UNDER) BUDGET					
PROJECTED EXPENDITURES UNDER(OVER) BUDGET					
RESERVED FUND BALANCE DECREASE(INCREASE)					
EMERGENCY RESERVE FUND BALANCE DECREASE(INCREASE)					
BEGINNING UNRESERVED FUND BALANCE	-	-	-	-	-
ENDING UNRESERVED FUND BALANCE	-	-	-	-	-
EMERGENCY RESERVE FUND	-	-	-	-	-



SPORTS COMPLEXES FUND REVENUE

	2013-14 <u>ACTUAL</u>	2014-15 <u>ACTUAL</u>	2015-16 <u>BUDGET</u>	2016-17 <u>PROPOSED</u>
Concessions	\$ 137,103	\$ 129,288	\$ 145,000	\$ 140,000
Concessions-Beer	20,526	19,104	21,140	20,000
Equipment Sales	2,076	2,192	7,188	2,300
Cost of Items Resold	(101,706)	(33,353)	(91,600)	(104,000)
Park Shelter Fees	435	-	-	-
Field Rental	11,150	12,262	11,000	13,125
Field Usage Fees-Capaha	29,591	35,398	29,591	34,091
League Fees	244,476	242,731	263,315	268,390
Entrance Fees	13,366	21,788	19,500	21,800
Tournament Fees	3,825	1,100	8,775	-
Special Event Fees	-	5,945	-	4,000
Project personnel costs	-	4,116	-	-
	<u>360,842</u>	<u>440,572</u>	<u>413,909</u>	<u>399,706</u>
Interest on Overnight Invments	381	404	500	500
Advertising Space Rental	-	-	7,000	7,000
Donations-Other	-	-	4,000	-
Cash Over and Short	4	-	-	-
General Miscellaneous	<u>367</u>	<u>282</u>	<u>300</u>	<u>150</u>
	752	686	11,800	7,650
Property sale (Proprietary)	<u>-</u>	<u>4,718</u>	<u>-</u>	<u>-</u>
	-	4,718	-	-
Transfer from General Fund	441,500	371,276	373,461	425,458
Transfer from Parks/Stormwtr-Operating	178,033	245,430	194,475	218,076
Transfer from Parks & Rec Foundation	<u>7,000</u>	<u>6,989</u>	<u>7,000</u>	<u>7,000</u>
	626,533	623,695	574,936	650,534
	<u>\$ 988,127</u>	<u>\$ 1,069,671</u>	<u>\$ 1,000,645</u>	<u>\$ 1,057,890</u>

SPORTS COMPLEXES

BUDGET BY MAJOR OBJECT

	2013-14 <u>ACTUAL</u>	2014-15 <u>ACTUAL</u>	2015-16 <u>BUDGET</u>	2016-17 <u>PROPOSED</u>
PERSONNEL COSTS	\$611,721	\$608,767	\$623,480	\$651,548
MATERIALS AND SUPPLIES	161,143	171,458	196,990	191,912
CONTRACTUAL SERVICES	103,932	80,559	77,457	102,265
GENERAL OPERATIONS	3,759	1,005	3,232	2,792
CAPITAL EXPENDITURES	-	-	-	7,500
SPECIAL PROJECTS	72,112	79,677	75,110	77,497
DEBT PAYMENTS	24,376	24,376	24,376	24,376
TRANSFERS	-	-	-	-
	<u>\$977,043</u>	<u>\$965,842</u>	<u>\$1,000,645</u>	<u>\$1,057,890</u>

TOTAL PERSONNEL SERVICE BY POSITION  
SOFTBALL COMPLEX

CLASSIFICATION	SALARY GRADE (Details in Appendices)	2015-2016 FISCAL YEAR	2016-2017 FISCAL YEAR
Regular Employees			
Assistant Division Manager	Grade P	1	1
Recreation Specialist	Grade M	0.5	0.5
Recreation Coordinator	Grade L	0	0.5
Maintenence Supervisor	Grade L	1	1
Sr. Maintenance Worker	Grade I	2	2
Maintenance Worker II	Grade G	2	2
Maintenance Worker	Grade E	<u>1</u>	<u>1</u>
<b>TOTAL</b>		7.5	8

Part-Time Employees

	2015-2016		2016-2017	
	<u>Actual Hours</u>	<u>Full-Time Equivalent</u>	<u>Actual Hours</u>	<u>Full-Time Equivalent</u>
Concession Managers	1,935	0.93	1,535	0.74
Concession Workers	4,417	2.12	4,064	1.95
Umpires	4,010	1.93	4,566	2.20
Officials	2,090	1.00	1,852	0.89
Assistant Facility Supervisor	249	0.12	211	0.10
Assistant Maintenance Worker	2,485	1.19	2,544	1.22
Assistant Coordinator	159	0.08	153	0.07
Activity Coordinator	23	0.01	0	0.00
Maintenance	3,286	1.58	3,286	1.58
Scorekeepers	1,738	0.84	2,001	0.96
Gate Workers	<u>538</u>	<u>0.26</u>	<u>434</u>	<u>0.21</u>
	20,930	10.06	20,646	9.93

---

THIS PAGE INTENTIONALLY LEFT BLANK

---

---

## **INTERNAL SERVICE FUNDS BUDGET HIGHLIGHTS**

### **ACTIVITIES**

Internal Service Funds are similar to Enterprise Funds except that the services are not rendered to the general public but are for other City departments.

**Information Technology** – Accounts for information technology related services provided to all City departments. Designs and maintains City-wide electronic information infrastructure. This fund is administered by the Administrative Services Department.

This budget provides \$58,900 for pc, monitor, and printer replacement, \$28,850 for pc telephones, and network switches at the new indoors sports complex, \$100,000 for an exchange server upgrade, and \$30,000 for network switch replacements.

**Fleet Management** - Accounts for the maintenance of the municipal fleet. This operation is administered by the Public Works Department.

This budget provides no money for capital outlays.

**Employee Benefit Fund** – Accounts for cost of health and dental coverage provided to the City's employees and retirees.

**Risk Management Fund** – Accounts for self-insured workmen's compensation coverage provided to City employees.

**Equipment Replacement Fund** - Buys equipment for and leases equipment to city non-enterprise funds. Lease payments will provide a source of revenue for repurchase of equipment in the future.

This budget provides \$532,500 for replacement of a dump truck, a boom mower, a loader, a service truck and a suburban.

### **REVENUE/RATE ADJUSTMENTS**

The fees paid by the various operating activities of the City provide the revenue for these funds. The allocated fees are adjusted annually, based on actual cost experience and projections.

---

THIS PAGE INTENTIONALLY LEFT BLANK

---

## INTERNAL SERVICE FUNDS 2016-2017 RESOURCES

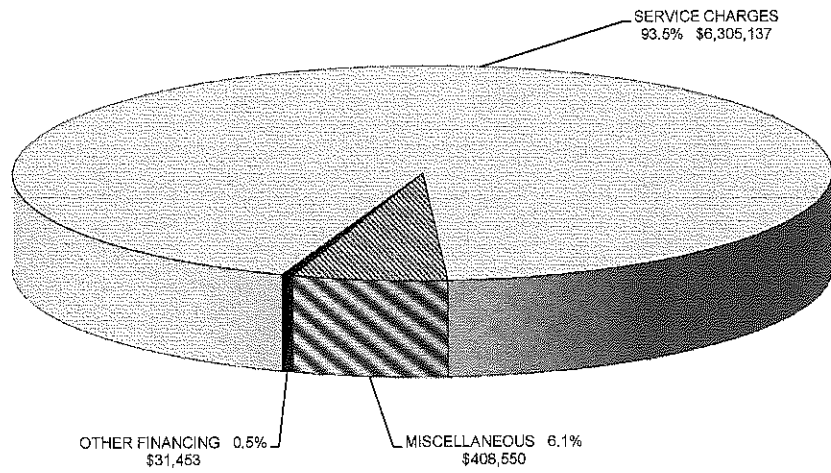

## INTERNAL SERVICE FUNDS 2016-2017 EXPENDITURES

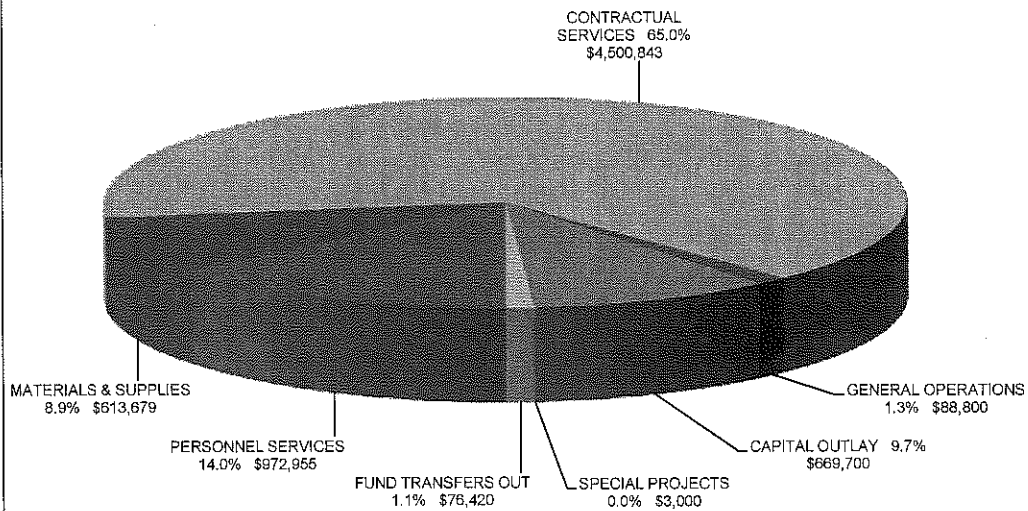

City of Cape Girardeau, Missouri  
 COMBINED STATEMENT OF REVENUES COLLECTED, EXPENDITURES PAID  
 AND CHANGES IN FUND BALANCES - INTERNAL SERVICE FUNDS  
 INFORMATION TECHNOLOGY FUND, FLEET, EMPLOYEE BENEFITS, RISK MANAGEMENT, AND  
 EQUIPMENT REPLACEMENT FUNDS

	<u>2013-14</u> <u>ACTUAL</u>	<u>2014-15</u> <u>ACTUAL</u>	<u>2015-16</u> <u>BUDGET</u>	<u>2016-17</u> <u>PROPOSED</u>
REVENUES COLLECTED:				
TAXES	\$ -	\$ -	\$ -	\$ -
LICENSES AND PERMITS	-	-	-	-
INTERGOVERN REVENUE	-	-	-	-
SERVICE CHARGES	6,411,892	6,404,844	6,227,573	6,305,137
FINES AND FORFEITS	-	-	-	-
MISCELLANEOUS	395,135	415,158	399,343	408,550
OTHER FINANCING	<u>37,997</u>	<u>93,160</u>	<u>59,668</u>	<u>31,453</u>
TOTAL REVENUE	\$6,845,024	\$6,913,162	\$6,686,584	\$6,745,140
EXPENSE OBJECT:				
PERSONNEL SERVICES	\$ 852,460	\$ 886,945	\$ 950,724	\$ 972,955
MATERIALS & SUPPLIES	619,078	624,304	571,935	613,679
CONTRACTUAL SERVICES	4,038,537	4,012,203	4,543,256	4,500,843
GENERAL OPERATIONS	44,355	62,283	61,300	88,800
CAPITAL OUTLAY	345,995	333,799	569,016	669,700
SPECIAL PROJECTS	-	2,057,695	-	3,000
DEBT SERVICE	<u>388</u>	<u>-</u>	<u>-</u>	<u>-</u>
TOTAL EXPENSES	<u>\$5,900,812</u>	<u>\$7,977,229</u>	<u>\$6,696,231</u>	<u>\$6,848,977</u>
FUND TRANSFERS IN	1,810	-	-	-
FUND TRANSFERS OUT	95,456	20,660	43,765	76,420
PROJECTED REVENUE OVER(UNDER) BUDGET			294,701	
PROJECTED EXPENDITURES UNDER(OVER) BUDGET			(259,664)	
RESERVED FUND BALANCE DECREASE(INCREASE)			-	
EMERGENCY RESERVE FUND BALANCE DECREASE(INCREASE)			-	-
BEGINNING UNRESERVED FUND BALANCE			5,563,982	5,545,607
ENDING UNRESERVED FUND BALANCE			<u>5,545,607</u>	<u>5,365,350</u>
EMERGENCY RESERVE FUND			<u>-</u>	<u>-</u>

---

# **INFORMATION TECHNOLOGY FUND**



---

THIS PAGE INTENTIONALLY LEFT BLANK

---

## INFORMATION TECHNOLOGY FUND 2016-2017 EXPENDITURES

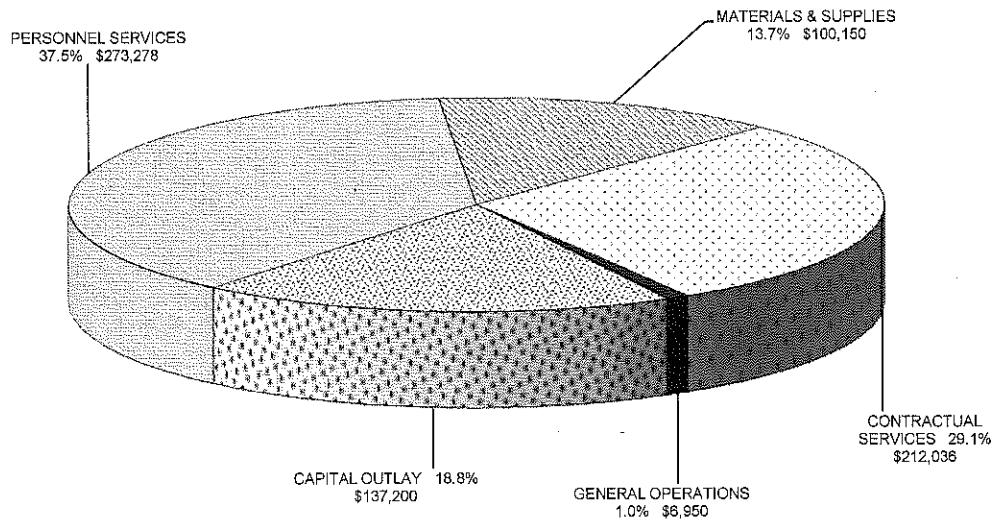

INFORMATION TECHNOLOGY FUND  
BUDGET BY MAJOR OBJECT

	<u>2013-14</u> <u>ACTUAL</u>	<u>2014-15</u> <u>ACTUAL</u>	<u>2015-16</u> <u>BUDGET</u>	<u>2016-17</u> <u>BUDGET</u>
REVENUE SOURCE:				
TAXES	\$ -	\$ -	\$ -	\$ -
LICENSES AND PERMITS	-	-	-	-
INTERGOVERN REVENUE	-	-	-	-
SERVICE CHARGES	620,090	644,164	685,500	702,000
FINES AND FORFEITS	-	-	-	-
MISCELLANEOUS	5,088	3,027	1,250	1,000
OTHER FINANCING	-	-	-	-
	<u>\$ 625,178</u>	<u>\$ 647,191</u>	<u>\$ 686,750</u>	<u>\$ 703,000</u>
EXPENSE OBJECT:				
PERSONNEL SERVICES	\$241,664	\$233,094	\$267,468	\$273,278
MATERIALS & SUPPLIES	98,906	91,919	75,300	100,150
CONTRACTUAL SERVICES	212,903	255,034	217,032	212,036
GENERAL OPERATIONS	3,716	3,220	6,950	6,950
CAPITAL OUTLAY	60,743	92,019	120,000	137,200
SPECIAL PROJECTS	-	-	-	-
DEBT SERVICE	-	-	-	-
	<u>\$617,932</u>	<u>\$675,286</u>	<u>\$686,750</u>	<u>\$729,614</u>
FUND TRANSFERS IN	-	-	-	-
FUND TRANSFERS OUT	-	-	-	-
PROJECTED REVENUE OVER(UNDER) BUDGET			250	
PROJECTED EXPENDITURES UNDER(OVER) BUDGET			(66,037)	
RESERVED FUND BALANCE DECREASE(INCREASE)				
EMERGENCY RESERVE FUND BALANCE DECREASE(INCREASE)				
BEGINNING UNRESERVED FUND BALANCE			163,729	97,942
ENDING UNRESERVED FUND BALANCE			<u>97,942</u>	<u>71,328</u>
EMERGENCY RESERVE FUND			<u>-</u>	<u>-</u>

INFORMATION TECHNOLOGY FUND REVENUE

	2013-14 <u>ACTUAL</u>	2014-15 <u>ACTUAL</u>	2015-16 <u>BUDGET</u>	2016-17 <u>PROPOSED</u>
Internal EDP Services	\$ 620,090	\$ 644,164	\$ 685,500	\$ 702,000
	620,090	644,164	685,500	702,000
Int on Overnight Investments	5,088	3,027	1,250	1,000
	5,088	3,027	1,250	1,000
	<u>\$625,178</u>	<u>\$647,191</u>	<u>\$686,750</u>	<u>\$703,000</u>

INFORMATION TECHNOLOGY FUND

BUDGET BY MAJOR OBJECT

	2013-14 <u>ACTUAL</u>	2014-15 <u>ACTUAL</u>	2015-16 <u>BUDGET</u>	2016-17 <u>PROPOSED</u>
PERSONNEL COSTS	\$241,664	\$233,094	\$267,468	\$273,278
MATERIALS AND SUPPLIES	98,906	91,919	75,300	100,150
CONTRACTUAL SERVICES	212,903	255,034	217,032	212,036
GENERAL OPERATIONS	3,716	3,220	6,950	6,950
CAPITAL EXPENDITURES	60,743	92,019	120,000	137,200
SPECIAL PROJECTS	-	-	-	-
DEBT PAYMENTS	-	-	-	-
TRANSFERS	-	-	-	-
	<u>\$617,932</u>	<u>\$675,286</u>	<u>\$686,750</u>	<u>\$729,614</u>

TOTAL PERSONNEL SERVICE BY POSITION  
INFORMATION TECHNOLOGY FUND

CLASSIFICATION	SALARY GRADE (Details in Appendices)		2015-2016 FISCAL YEAR	2016-2017 FISCAL YEAR
Regular Employees				
Director of Citizens Services	Grade	U	0.15	0.15
IT Director	Grade	T	1	1
Senior Networking Engineer	Grade	Q	1	1
Network Engineer	Grade	O	1	1
TOTAL			3.15	3.15
Part-Time Employees				
	2015-2016		2016-2017	
	Actual Number	Full-Time Equivalent	Actual Number	Full-Time Equivalent
Network Tech	<u>1040</u>	<u>0.50</u>	<u>1040</u>	<u>0.50</u>
	1040	0.50	1040	0.50

---

# **FLEET MANAGEMENT FUND**

---

THIS PAGE INTENTIONALLY LEFT BLANK

---

## FLEET MANAGEMENT FUND 2016-2017 EXPENDITURES

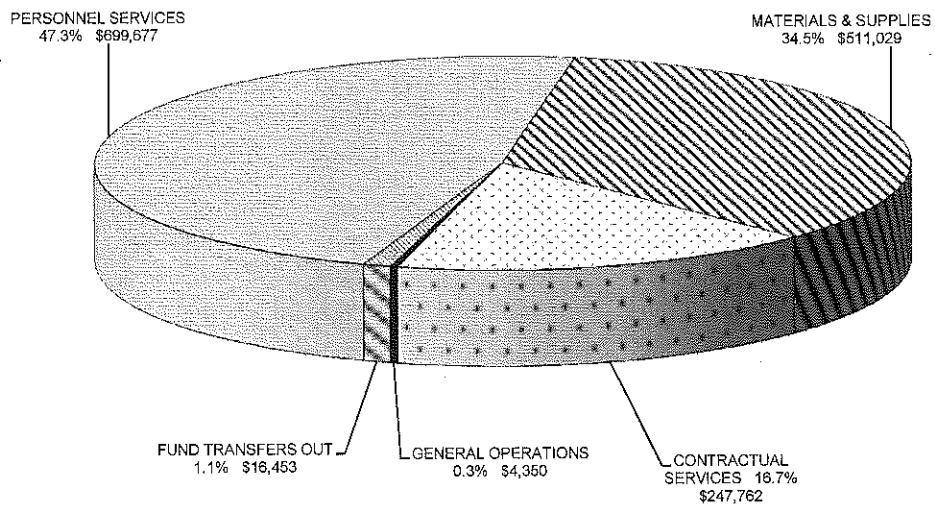



FLEET MANAGEMENT FUND  
BUDGET BY MAJOR OBJECT

	2013-14 <u>ACTUAL</u>	2014-15 <u>ACTUAL</u>	2015-16 <u>BUDGET</u>	2016-17 <u>BUDGET</u>
REVENUE SOURCE:				
TAXES	\$ -	\$ -	\$ -	\$ -
LICENSES AND PERMITS	-	-	-	-
INTERGOVERN REVENUE	-	-	-	-
SERVICE CHARGES	1,440,616	1,451,680	1,425,769	1,460,000
FINES AND FORFEITS	-	-	-	-
MISCELLANEOUS	6,639	4,403	3,239	2,818
OTHER FINANCING	<u>15,612</u>	<u>21,343</u>	<u>16,168</u>	<u>16,453</u>
TOTAL REVENUE	\$1,462,867	\$1,477,426	\$1,445,176	\$1,479,271
EXPENSE OBJECT:				
PERSONNEL SERVICES	\$ 610,795	\$ 653,851	\$ 683,256	\$ 699,677
MATERIALS & SUPPLIES	520,172	531,573	494,135	511,029
CONTRACTUAL SERVICES	254,775	234,377	247,267	247,762
GENERAL OPERATIONS	1,976	4,115	4,350	4,350
CAPITAL OUTLAY	-	6,228	-	-
SPECIAL PROJECTS	-	-	-	-
DEBT SERVICE	<u>388</u>	<u>-</u>	<u>-</u>	<u>-</u>
TOTAL EXPENSES	<u>\$1,388,106</u>	<u>\$1,430,143</u>	<u>\$1,429,008</u>	<u>\$1,462,818</u>
FUND TRANSFERS IN	-	-	-	-
FUND TRANSFERS OUT	15,612	20,660	16,168	16,453
PROJECTED REVENUE				
OVER(UNDER) BUDGET			102,268	
PROJECTED EXPENDITURES				
UNDER(OVER) BUDGET			(102,268)	
RESERVED FUND BALANCE				
DECREASE(INCREASE)				
EMERGENCY RESERVE FUND BALANCE				
DECREASE(INCREASE)				
BEGINNING UNRESERVED FUND				
BALANCE			152,200	152,200
ENDING UNRESERVED FUND				
BALANCE			<u>152,200</u>	<u>152,200</u>
EMERGENCY RESERVE FUND			<u>-</u>	<u>-</u>

FLEET MANAGEMENT FUND REVENUE

	2013-14 <u>ACTUAL</u>	2014-15 <u>ACTUAL</u>	2015-16 <u>BUDGET</u>	2016-17 <u>PROPOSED</u>
Internal Fleet Services	<u>\$1,440,616</u>	<u>\$1,451,680</u>	<u>\$1,425,769</u>	<u>\$ 1,460,000</u>
	1,440,616	1,451,680	1,425,769	1,460,000
Int on Overnight Investments	33	400	136	-
Interest On Notes Receivable	4,119	3,384	3,103	2,818
Miscellaneous	<u>2,487</u>	<u>619</u>	<u>-</u>	<u>-</u>
	6,639	4,403	3,239	2,818
Gain From Sale of Asset	<u>15,612</u>	<u>21,343</u>	<u>16,168</u>	<u>16,453</u>
	15,612	21,343	16,168	16,453
	<u>\$1,462,867</u>	<u>\$1,477,426</u>	<u>\$1,445,176</u>	<u>\$ 1,479,271</u>

FLEET MANAGEMENT

BUDGET BY MAJOR OBJECT

	2013-14 <u>ACTUAL</u>	2014-15 <u>ACTUAL</u>	2015-16 <u>BUDGET</u>	2016-17 <u>PROPOSED</u>
PERSONNEL COSTS	\$610,795	\$653,851	\$683,256	\$699,677
MATERIALS AND SUPPLIES	520,172	531,573	494,135	511,029
CONTRACTUAL SERVICES	254,775	234,377	247,267	247,762
GENERAL OPERATIONS	1,976	4,115	4,350	4,350
CAPITAL EXPENDITURES	-	6,228	-	-
SPECIAL PROJECTS	-	-	-	-
DEBT PAYMENTS	388	-	-	-
TRANSFERS	15,612	20,660	16,168	16,453
	<u>\$1,403,718</u>	<u>\$1,450,803</u>	<u>\$1,445,176</u>	<u>\$1,479,271</u>

TOTAL PERSONNEL SERVICE BY POSITION

FLEET MANAGEMENT

CLASSIFICATION	SALARY GRADE	2015-2016 FISCAL YEAR	2016-2017 FISCAL YEAR
Regular Employees			
Public Works Director	Grade V	0.20	0.20
Assistant Public Works Director	Grade U	0.25	0.25
Fleet Manager	Grade O	0.50	0.50
Fleet Maintenance Supervisor	Grade M	1	1
Senior Mechanic	Grade L	1	1
PW System/GIS Analyst	Grade L	0.25	0.25
Fleet Mechanic II	Grade K	5	5
Fleet Specialist	Grade I	1	1
Administrative Technician	Grade G	0.25	0.25
Parts Technician	Grade D	1	1
Administrative Secretary	Grade E	1	1
Maintenance Worker	Grade E	1	0
Building Maintenance Worker	Grade B	0	1
TOTAL		12.45	12.45

---

# **EMPLOYEE BENEFITS FUND**

EMPLOYEE BENEFITS FUND  
BUDGET BY MAJOR OBJECT

	2013-14 <u>ACTUAL</u>	2014-15 <u>ACTUAL</u>	2015-16 <u>BUDGET</u>	2016-17 <u>BUDGET</u>
REVENUE SOURCE:				
TAXES	\$ -	\$ -	\$ -	\$ -
LICENSES AND PERMITS	-	-	-	-
INTERGOVERN REVENUE	-	-	-	-
SERVICE CHARGES	3,734,019	3,793,739	3,595,604	3,604,089
FINES AND FORFEITS	-	-	-	-
MISCELLANEOUS	39,334	48,819	25,000	25,000
OTHER FINANCING	-	-	-	-
	<hr/>	<hr/>	<hr/>	<hr/>
TOTAL REVENUE	\$ 3,773,353	\$ 3,842,558	\$ 3,620,604	\$ 3,629,089
EXPENSE OBJECT:				
PERSONNEL SERVICES	\$ -	\$ -	\$ -	\$ -
MATERIALS & SUPPLIES	-	801	-	-
CONTRACTUAL SERVICES	2,940,500	3,202,516	3,593,007	3,541,122
GENERAL OPERATIONS	-	-	-	25,000
CAPITAL OUTLAY	-	-	-	-
SPECIAL PROJECTS	-	1,687,800	-	3,000
DEBT SERVICE	-	-	-	-
	<hr/>	<hr/>	<hr/>	<hr/>
TOTAL EXPENSES	\$ 2,940,500	\$ 4,891,117	\$ 3,593,007	\$ 3,569,122
FUND TRANSFERS IN	-	-	-	-
FUND TRANSFERS OUT	79,844	-	27,597	59,967
PROJECTED REVENUE				
OVER(UNDER) BUDGET			244,996	
PROJECTED EXPENDITURES				
UNDER(OVER) BUDGET			53,500	
RESERVED FUND BALANCE				
DECREASE(INCREASE)				
EMERGENCY RESERVE FUND BALANCE				
DECREASE(INCREASE)				
BEGINNING UNRESERVED FUND				
BALANCE			2,283,417	2,581,913
ENDING UNRESERVED FUND				
BALANCE			<hr/> <u>2,581,913</u>	<hr/> <u>2,581,913</u>
EMERGENCY RESERVE FUND			<hr/> <u>-</u>	<hr/> <u>-</u>

EMPLOYEE BENEFITS FUND REVENUE

	2013-14 <u>ACTUAL</u>	2014-15 <u>ACTUAL</u>	2015-16 <u>BUDGET</u>	2016-17 <u>PROPOSED</u>
Internal Health Prem.-Employee	\$2,902,647	\$2,974,541	\$2,827,434	\$2,898,524
Internal Health Prem.-Retiree	831,372	801,327	748,170	685,565
Cobra Health & Dental	-	17,871	20,000	20,000
	<u>3,734,019</u>	<u>3,793,739</u>	<u>3,595,604</u>	<u>3,604,089</u>
Interest on Overnight Invments	39,191	48,330	25,000	25,000
Interest on Investments	2	2	-	-
General Miscellaneous	141	487	-	-
	<u>39,334</u>	<u>48,819</u>	<u>25,000</u>	<u>25,000</u>
	<u>\$3,773,353</u>	<u>\$3,842,558</u>	<u>\$3,620,604</u>	<u>\$3,629,089</u>

EMPLOYEE BENEFITS

BUDGET BY MAJOR OBJECT

	2013-14 <u>ACTUAL</u>	2014-15 <u>ACTUAL</u>	2015-16 <u>BUDGET</u>	2016-17 <u>PROPOSED</u>
PERSONNEL COSTS	\$ -	\$ -	\$ -	\$ -
MATERIALS AND SUPPLIES	-	801	-	-
CONTRACTUAL SERVICES	2,940,500	3,202,516	3,593,007	3,541,122
GENERAL OPERATIONS	-	-	-	25,000
CAPITAL EXPENDITURES	-	-	-	-
SPECIAL PROJECTS	-	1,687,800	-	3,000
DEBT PAYMENTS	-	-	-	-
TRANSFERS	79,844	-	27,597	59,967
	<u>\$3,020,344</u>	<u>\$4,891,117</u>	<u>\$3,620,604</u>	<u>\$3,629,089</u>

---

# **RISK MANAGEMENT FUND**



RISK MANAGEMENT FUND  
BUDGET BY MAJOR OBJECT

	<u>2013-14</u> <u>ACTUAL</u>	<u>2014-15</u> <u>ACTUAL</u>	<u>2015-16</u> <u>BUDGET</u>	<u>2016-17</u> <u>BUDGET</u>
REVENUE SOURCE:				
TAXES	\$ -	\$ -	\$ -	\$ -
LICENSES AND PERMITS	-	-	-	-
INTERGOVERN REVENUE	-	-	-	-
SERVICE CHARGES	617,167	515,261	520,700	539,048
FINES AND FORFEITS	-	-	-	-
MISCELLANEOUS	22,377	22,779	17,750	15,875
OTHER FINANCING	-	-	-	-
	\$ 639,544	\$ 538,040	\$ 538,450	\$ 554,923
EXPENSE OBJECT:				
PERSONNEL SERVICES	\$ -	\$ -	\$ -	\$ -
MATERIALS & SUPPLIES	-	-	2,500	2,500
CONTRACTUAL SERVICES	630,359	320,276	485,950	499,923
GENERAL OPERATIONS	38,663	54,948	50,000	52,500
CAPITAL OUTLAY	-	-	-	-
SPECIAL PROJECTS	-	369,895	-	-
DEBT SERVICE	-	-	-	-
	\$ 669,022	\$ 745,119	\$ 538,450	\$ 554,923
FUND TRANSFERS IN	-	-	-	-
FUND TRANSFERS OUT	-	-	-	-
PROJECTED REVENUE OVER(UNDER) BUDGET			(20,875)	
PROJECTED EXPENDITURES UNDER(OVER) BUDGET			(257,875)	
RESERVED FUND BALANCE DECREASE(INCREASE)				
EMERGENCY RESERVE FUND BALANCE DECREASE(INCREASE)				
BEGINNING UNRESERVED FUND BALANCE			1,571,992	1,293,242
ENDING UNRESERVED FUND BALANCE			1,293,242	1,293,242
EMERGENCY RESERVE FUND			-	-

RISK MANAGEMENT FUND REVENUE

	2013-14 <u>ACTUAL</u>	2014-15 <u>ACTUAL</u>	2015-16 <u>BUDGET</u>	2016-17 <u>PROPOSED</u>
Internal Work Comp Premium	<u>\$ 617,167</u>	<u>\$ 515,261</u>	<u>\$ 520,700</u>	<u>\$ 539,048</u>
	617,167	515,261	520,700	539,048
Interest on Overnight Invments	21,500	21,447	16,875	15,000
Interest on Investments	<u>877</u>	<u>1,332</u>	<u>875</u>	<u>875</u>
	22,377	22,779	17,750	15,875
	<u>\$639,544</u>	<u>\$538,040</u>	<u>\$538,450</u>	<u>\$554,923</u>

RISK MANAGEMENT

BUDGET BY MAJOR OBJECT

	2013-14 <u>ACTUAL</u>	2014-15 <u>ACTUAL</u>	2015-16 <u>BUDGET</u>	2016-17 <u>PROPOSED</u>
PERSONNEL COSTS	\$ -	\$ -	\$ -	\$ -
MATERIALS AND SUPPLIES	-	-	2,500	2,500
CONTRACTUAL SERVICES	630,359	320,276	485,950	499,923
GENERAL OPERATIONS	38,663	54,948	50,000	52,500
CAPITAL EXPENDITURES	-	-	-	-
SPECIAL PROJECTS	-	369,895	-	-
DEBT PAYMENTS	-	-	-	-
TRANSFERS	-	-	-	-
	<u>\$669,022</u>	<u>\$745,119</u>	<u>\$538,450</u>	<u>\$554,923</u>

---

# **EQUIPMENT REPLACEMENT FUND**

EQUIPMENT REPLACEMENT FUND  
BUDGET BY MAJOR OBJECT

	2013-14 <u>ACTUAL</u>	2014-15 <u>ACTUAL</u>	2015-16 <u>BUDGET</u>	2016-17 <u>BUDGET</u>
REVENUE SOURCE:				
TAXES	\$ -	\$ -	\$ -	\$ -
LICENSES AND PERMITS	-	-	-	-
INTERGOVERN REVENUE	-	-	-	-
SERVICE CHARGES	-	-	-	-
FINES AND FORFEITS	-	-	-	-
MISCELLANEOUS	321,697	336,130	352,104	363,857
OTHER FINANCING	<u>22,385</u>	<u>71,817</u>	<u>43,500</u>	<u>15,000</u>
TOTAL REVENUE	\$ 344,082	\$ 407,947	\$ 395,604	\$ 378,857
EXPENSE OBJECT:				
PERSONNEL SERVICES	\$ -	\$ -	\$ -	\$ -
MATERIALS & SUPPLIES	-	12	-	-
CONTRACTUAL SERVICES	-	-	-	-
GENERAL OPERATIONS	-	-	-	-
CAPITAL OUTLAY	285,252	235,552	449,016	532,500
SPECIAL PROJECTS	-	-	-	-
DEBT SERVICE	<u>-</u>	<u>-</u>	<u>-</u>	<u>-</u>
TOTAL EXPENSES	<u>\$ 285,252</u>	<u>\$ 235,564</u>	<u>\$ 449,016</u>	<u>\$ 532,500</u>
FUND TRANSFERS IN	1,810	-	-	-
FUND TRANSFERS OUT	-	-	-	-
PROJECTED REVENUE OVER(UNDER) BUDGET			(31,938)	
PROJECTED EXPENDITURES UNDER(OVER) BUDGET			113,016	
RESERVED FUND BALANCE DECREASE(INCREASE)				
EMERGENCY RESERVE FUND BALANCE DECREASE(INCREASE)				
BEGINNING UNRESERVED FUND BALANCE			1,392,644	1,420,310
ENDING UNRESERVED FUND BALANCE			<u>1,420,310</u>	<u>1,266,667</u>
EMERGENCY RESERVE FUND			<u>-</u>	<u>-</u>

EQUIPMENT REPLACEMENT FUND REVENUE

	2013-14 <u>ACTUAL</u>	2014-15 <u>ACTUAL</u>	2015-16 <u>BUDGET</u>	2016-17 <u>PROPOSED</u>
Interest on Overnight Investments	\$ 15,845	\$ 16,601	\$ 12,500	\$ 12,500
Lease Revenue	<u>305,852</u>	<u>319,528</u>	<u>339,604</u>	<u>351,357</u>
	321,697	336,130	352,104	363,857
Proceeds from Sale of Assets	22,385	-	43,500	15,000
Property sale (Proprietary)	<u>-</u>	<u>71,817</u>	<u>-</u>	<u>-</u>
	22,385	71,817	43,500	15,000
Transfer-Sewer Fund	<u>1,810</u>	<u>-</u>	<u>-</u>	<u>-</u>
	1,810	-	-	-
	<u>\$ 345,892</u>	<u>\$ 407,947</u>	<u>\$395,604</u>	<u>378,857</u>

---

EQUIPMENT REPLACEMENT

BUDGET BY MAJOR OBJECT

	2013-14 <u>ACTUAL</u>	2014-15 <u>ACTUAL</u>	2015-16 <u>BUDGET</u>	2016-17 <u>PROPOSED</u>
PERSONNEL COSTS	\$ -	\$ -	\$ -	\$ -
MATERIALS AND SUPPLIES	-	12	-	-
CONTRACTUAL SERVICES	-	-	-	-
GENERAL OPERATIONS	-	-	-	-
CAPITAL EXPENDITURES	285,252	235,552	449,016	532,500
SPECIAL PROJECTS	-	-	-	-
DEBT PAYMENTS	-	-	-	-
TRANSFERS	-	-	-	-
	<u>\$285,252</u>	<u>\$235,564</u>	<u>\$449,016</u>	<u>\$ 532,500</u>

CAPE GIRARDEAU CITIZENS

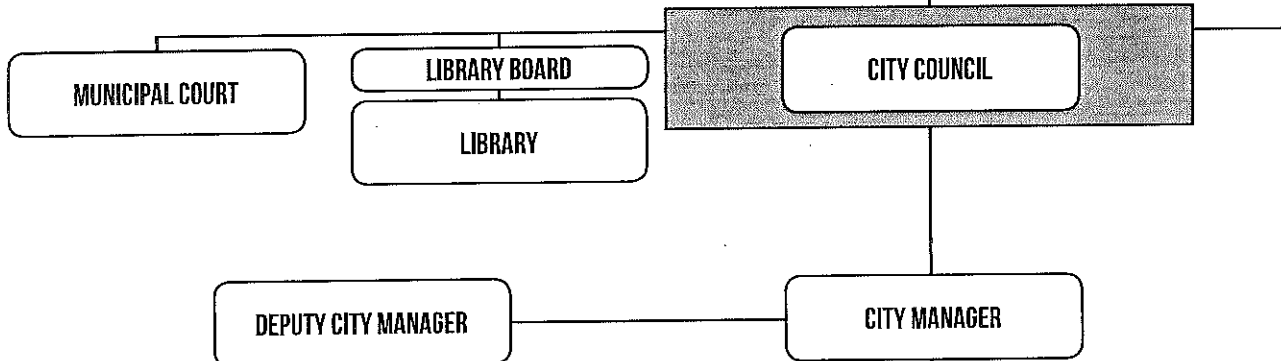

- CITIZEN ADVISORY BOARDS AND COMMISSIONS**
- AIRPORT ADVISORY BOARD
  - BOARD OF ADJUSTMENT
  - BOARD OF APPEALS
  - BOARD OF EXAMINERS
  - GOLF COURSE ADVISORY BOARD
  - HISTORIC PRESERVATION COMMISSION
  - KEEP CAPE BEAUTIFUL BEAUTIFICATION COMMITTEE
  - PARKS & RECREATION ADVISORY BOARD
  - LIQUOR LICENSE REVIEW BOARD
  - RIVER CAMPUS BOARD OF MANAGERS
  - SHOW ME CENTER BOARD OF MANAGERS
  - SPECIAL BUSINESS DISTRICT ADVISORY COMMISSION
  - TAX INCREMENT FINANCING COMMISSION
  - TREE BOARD

**PUBLIC WORKS DEPARTMENT**

- STREET
- FLEET MANAGEMENT
- STORMWATER MAINTENANCE
- LEVEE SYSTEM
- WASTEWATER
- BIOSDLIDS
- RESIDENTIAL SOLID WASTE
- RECYCLING
- TRANSFER STATION
- WATER

**HUMAN RESOURCES OFFICE**

- PAYROLL/PERSONNEL
- RISK MANAGEMENT

**DEVELOPMENT SERVICES DEPARTMENT**

- PLANNING SERVICES
- ENGINEERING SERVICES
- GEOGRAPHIC INFORMATION SERVICES
- INSPECTION SERVICES

**FINANCE OFFICE**

- ACCOUNTING
- ACCOUNTS PAYABLE/RECEIVING

**REGIONAL AIRPORT**

- CAPE AIR
- FIXED BASE OPERATIONS (FBO)

**PARKS & RECREATION DEPARTMENT**

- A.C. BRASE ARENA
- CAPE SPLASH
- CEMETERY DIVISION
- CENTRAL MUNICIPAL POOL
- FACILITY DIVISION
- JAYCEE MUNICIPAL GOLF COURSE
- OSAGE CENTRE
- PARKS DIVISION
- RECREATION DIVISION
- SHAWNEE CENTER
- SHAWNEE SPORTS COMPLEX



**POLICE DEPARTMENT**

- PATROL
- DETECTIVE
- TRAFFIC
- SCHOOLS/COMMUNITY
- NUISANCE ABATEMENT
- JAIL
- TRAINING, TECHNOLOGY & COMMUNITY AFFAIRS
- RECORDS
- COMMUNICATIONS/9 11

**LEGAL OFFICE**

- CITY ATTORNEY
- CITY PROSECUTOR

**FIRE DEPARTMENT**

- OPERATIONS
- SUPPORT SERVICES
- COMMUNITY SERVICES
- PERSONNEL SERVICES
- EMERGENCY MANAGEMENT

**CITIZEN SERVICES DEPARTMENT**

- CITY CLERK
- CUSTOMER SERVICE: BILLING, LICENSING, PERMITS
- RECORDS CUSTODIAN
- COLLECTIONS
- PUBLIC INFORMATION: WEBSITE, MEDIA, SOCIAL
- INFORMATION TECHNOLOGY



SPECIAL PROJECTS

	2013-14 <u>ACTUAL</u>	2014-15 <u>ACTUAL</u>	2015-16 <u>BUDGETED</u>	2016-17 <u>PROPOSED</u>
<u>General Projects</u>				
City Training Library	\$ -	\$ -	\$ 200	\$ 200
Employee Awards and Recognition	4,442	3,570	8,130	7,380
Historic Preservation Project	693	472	1,000	1,300
Highway Safety (Nongrant)	(189)	(68)	-	-
Team Spirit Grant	93,230	112,854	148,500	151,000
Safe Communities Expense	16,702	16,802	31,500	28,448
Community Trials Initiative Grant	341	325	-	450
Citizens Corps Grants	84	-	-	-
SEMO Regional Planning Commission	7,700	1,226	-	-
Police Reserves	617	755	1,000	-
Emergency Preparedness	6,000	5,354	6,000	6,000
Community Development Project	1,228	1,021	10,000	5,000
Special Event Costs	2,650	1,000	1,100	1,500
Economic Development-General	72,978	72,978	77,440	73,000
Economic Development Projects	17,218	6,140	10,000	5,000
Public Transportation	110,000	110,000	110,000	110,000
Sink Hole Mitigation	2,465	-	-	-
Ride the City Project	4,658	-	-	-
Emergency Solutions Grant	236,348	175,509	-	-
United Way	2,500	2,500	2,500	2,500
Restroom Facility-University	107,947	(10,459)	-	-
C.M. Projects	-	-	30,000	30,000
<b>Total</b>	<b>\$ 687,611</b>	<b>\$ 499,978</b>	<b>\$ 437,370</b>	<b>\$ 421,778</b>
<u>Conv/Tourism Projects</u>				
Economic Development-River Campus	\$ 1,293,081	\$ (19,038)	\$ -	\$ -
Tourism Projects	40,000	-	-	-
<b>Total</b>	<b>\$ 1,333,081</b>	<b>\$ (19,038)</b>	<b>\$ -</b>	<b>\$ -</b>
<u>Airport Projects</u>				
Community Development Project	\$ 900	\$ -	\$ 1,000	\$ 1,000
Special Event Costs	191,746	48	-	-
<b>Total</b>	<b>\$ 192,646</b>	<b>\$ 48</b>	<b>\$ 1,000</b>	<b>\$ 1,000</b>
<u>Park Projects</u>				
League Events	\$ 25,032	\$ 25,266	\$ 25,685	\$ 27,425
Special Events Costs	56,886	82,147	60,905	82,735
Program Costs	9,471	5,995	6,825	7,400
<b>Total</b>	<b>\$ 91,390</b>	<b>\$ 113,409</b>	<b>\$ 93,415</b>	<b>\$ 117,560</b>
<u>Capital Improvement Sales Tax</u>				
Economic Development Projects	\$ 448,802	\$ 557,935	\$ 495,000	\$ 285,600
<b>Total</b>	<b>\$ 448,802</b>	<b>\$ 557,935</b>	<b>\$ 495,000</b>	<b>\$ 285,600</b>
<u>Parks and Stormwater Sales Tax</u>				
Department of Conservation -Trees Maintenance Program	\$ (9,200)	\$ -	\$ -	\$ -
	\$ (9,200)	\$ -	\$ -	\$ -
<u>CDBG Grants</u>				
Comm Devl Proj-Business Incubat	\$ -	\$ 500,000	\$ -	\$ -
Business Park Infrastructure	141,723	2,448,132	-	-
	\$ 141,723	\$ 2,948,132	\$ -	\$ -

SPECIAL PROJECTS

	2013-14 <u>ACTUAL</u>	2014-15 <u>ACTUAL</u>	2015-16 <u>BUDGETED</u>	2016-17 <u>PROPOSED</u>
<u>Housing Development Grants</u>				
HUD-Neighborhood Stabilization Program	\$ 6,770	\$ 100,745	\$ 200,000	\$ 200,000
Federal Home Loan Bank Grant	84,587	129,966	-	-
	<u>\$ 91,356</u>	<u>\$ 230,711</u>	<u>\$ 200,000</u>	<u>\$ 200,000</u>
<u>Health</u>				
County Health Department	\$ 21,150	\$ 21,150	\$ 21,150	\$ 21,150
Human Society	47,000	55,935	57,500	59,300
Special Animal Control Project	1,396	976	2,000	2,000
First Responder	15,638	30,802	27,000	27,000
	<u>\$ 85,183</u>	<u>\$ 108,863</u>	<u>\$ 107,650</u>	<u>\$ 109,450</u>
<u>Casino Revenue Projects</u>				
Riverfront Economic Development	\$ 92,299	\$ 113,023	\$ 96,000	\$ 96,000
Old Towne Cape	-	100,800	111,000	114,000
	<u>\$ 92,299</u>	<u>\$ 213,823</u>	<u>\$ 207,000</u>	<u>\$ 210,000</u>
<u>Sewer Projects</u>				
Sewer Treatment Maint. Project	\$ 12,502	\$ 16,712	\$ 18,000	\$ 18,000
	<u>\$ 12,502</u>	<u>\$ 16,712</u>	<u>\$ 18,000</u>	<u>\$ 18,000</u>
<u>Water Projects</u>				
Meter Replacement Program	\$ 217,314	\$ 242,311	\$ 250,000	\$ -
Other City Projects	17,761	-	-	-
	<u>\$ 235,075</u>	<u>\$ 242,311</u>	<u>\$ 250,000</u>	<u>\$ -</u>
<u>Solid Waste Projects</u>				
Leaf Collection	\$ 49,083	\$ 26,946	\$ 38,000	\$ 38,000
Public Education	26,700	12,600	18,824	30,000
	<u>\$ 75,783</u>	<u>\$ 39,546</u>	<u>\$ 56,824</u>	<u>\$ 68,000</u>
<u>Golf Projects</u>				
Special Events	\$ 6,467	\$ 4,634	\$ 7,500	\$ 11,500
	<u>\$ 6,467</u>	<u>\$ 4,634</u>	<u>\$ 7,500</u>	<u>\$ 11,500</u>
<u>Softball Complex Projects</u>				
Tournaments	\$ 68,487	\$ 73,792	\$ 68,410	\$ 71,797
	3,625	5,885	6,700	5,700
	<u>\$ 72,112</u>	<u>\$ 79,677</u>	<u>\$ 75,110</u>	<u>\$ 77,497</u>
<u>Employee Benefits Fund</u>				
Federal Taxes	\$ -	\$ 37,800	\$ -	\$ 3,000
	<u>\$ -</u>	<u>\$ 37,800</u>	<u>\$ -</u>	<u>\$ 3,000</u>
<b>TOTAL SPECIAL PROJECTS</b>	<u><u>\$ 3,556,831</u></u>	<u><u>\$ 5,074,542</u></u>	<u><u>\$ 1,948,869</u></u>	<u><u>\$ 1,808,985</u></u>

---

THIS PAGE INTENTIONALLY LEFT BLANK

---

CAPITAL PROJECTS

	2013-14 <u>ACTUAL</u>	2014-15 <u>ACTUAL</u>	2015-16 <u>BUDGET</u>	2016-17 <u>PROPOSED</u>
<u>Airport</u>				
Observation Area	\$ -	\$ -	\$ -	\$ 30,000
Baggage Enhancement	-	-	-	30,000
	<u>\$ -</u>	<u>\$ -</u>	<u>\$ -</u>	<u>\$ 60,000</u>
<u>General Capital Imp. Projects</u>				
Replace Railroad Crossing on Nash Road	\$ (6,550)	\$ -	\$ -	\$ -
T-Hanger #1 & Taxi Lanes	732,961	8,409	-	-
Police Station	-	-	-	10,960,000
Fire Station #1	-	-	-	3,000,000
Fire Station #2	-	-	-	495,000
Fire Station #4	-	-	-	1,260,000
	<u>\$ 726,411</u>	<u>\$ 8,409</u>	<u>\$ -</u>	<u>\$ 15,715,000</u>
<u>Street Capital Improvement</u>				
Sprigg Street Bridge	\$ -	473,971	\$ 4,100,000	\$ -
Total	<u>\$ -</u>	<u>473,971</u>	<u>\$ 4,100,000</u>	<u>\$ -</u>
<u>STP-U Projects</u>				
Lewis and Clark Parkway	\$ (15,343)	\$ -	\$ -	\$ -
Independence/Gordonville Intersection Improvments	-	-	200,000	-
Total	<u>\$ (15,343)</u>	<u>\$ -</u>	<u>\$ 200,000</u>	<u>\$ -</u>
<u>Park Improvements</u>				
Mississippi Riverwalk IV	\$ 3,194	\$ 816,997	\$ -	\$ -
Total	<u>\$ 3,194</u>	<u>\$ 816,997</u>	<u>\$ -</u>	<u>\$ -</u>
<u>Casino Revenue Fund</u>				
Transfer Station	\$ -	\$ -	\$ -	\$ -
Police Station	-	-	-	-
Radio Interoperability	-	-	1,446,464	-
River Heritage Museum Parking Lot	58,402	-	-	-
Main Street Lighting Improvements	26,704	5,398	-	-
Fort D	130	(5,350)	-	-
Sidewalk-Storey's to Janet	7,713	118,839	-	-
Business Park Sanitary Sewer Improvement	946,861	120,659	-	-
	<u>\$ 1,039,810</u>	<u>\$ 239,546</u>	<u>\$ 1,446,464</u>	<u>\$ -</u>

CAPITAL PROJECTS

	2013-14 <u>ACTUAL</u>	2014-15 <u>ACTUAL</u>	2015-16 <u>BUDGET</u>	2016-17 <u>PROPOSED</u>
<u>Riverfront Region Economic Development Fund</u>				
Riverfront Projects	\$ -	\$ -	\$ -	\$ 720,000
	<u>\$ -</u>	<u>\$ -</u>	<u>\$ -</u>	<u>\$ 720,000</u>
<u>Enterprise Funds Projects</u>				
I/I Program	\$ 256,675	\$ 1,479,494	\$ 800,000	\$ -
Other Sewer Projects	21,239	3,109	-	-
Broadway Stormwater Relief Sewer	2,383,857	236,932	-	-
Main Extensions for Development	3,409	168	125,000	125,000
2" Water Main Replacement	98,748	38,392	125,000	125,000
Wastewater Treatment Plant Replacement	2,097,417	1,063,201	-	-
Scada Upgrades	15,600	39,946	-	-
Water Distribution Improvements	-	57,670	100,000	100,000
Plant 2 Clear Well	282,922	(40,597)	-	-
Meadowbrook Pressure Zone Improvements	1,296,108	13,229	-	-
Distribution Main-Co Rd 618 & Ballwin & Veterans Memorial Drive	56,775	958,458	-	-
LaSalle BPS / Generator / Transmissions Main	155,138	(4,483)	2,145,000	-
Plant 1 Seismic Vulnerability Upgrade	-	-	-	395,000
Plant 1 Basin/filter Rehab	-	-	-	1,091,000
Plant 1 Residuals	5,240	45	-	-
LaSalle Tank	133,658	321,953	2,730,000	-
Cape Rock/Perryville BPS and Generator	78,783	98,030	435,000	-
Merriweather Pumping Station-Generator	856	-	-	-
Remodel Customer Service Area PW	-	-	-	21,000
Gordonville Booster Pump	-	-	865,300	-
Twin Lakes Lift Station Replacement	-	-	85,000	-
Boulder Crest Lift Station Rehab	-	-	75,000	-
I-55 & US-61 Lift Station Rehab	-	-	80,000	-
24" Forcemain assessment	-	-	-	110,000
Lift Station Retrolift	-	-	-	120,000
Dalhousie Lift Station Upgrade	-	-	-	240,000
Pressure Zone Improvement	-	-	-	348,500
Gordonville Tank Painting	-	-	474,200	490,800
Total	<u>\$ 6,886,425</u>	<u>\$ 4,265,546</u>	<u>\$ 8,039,500</u>	<u>\$ 3,166,300</u>

CAPITAL PROJECTS

	<u>2013-14 ACTUAL</u>	<u>2014-15 ACTUAL</u>	<u>2015-16 BUDGET</u>	<u>2016-17 PROPOSED</u>
<u>Transportation Sales Tax</u>				
Street, Curb, Gutter Program	\$ 398,255	\$ 824,000	\$ -	\$ 850,000
Existing Street Paving Program	201,252	304,751	675,000	375,000
Sidewalk Reconstruction	-	-	910,000	
Lighting associated with Downtown Sidewalks	-	-	150,000	
Broadway Enhancement/Pacific-Water Ph 1	3,873	-	-	-
Armstrong Drive	(5,434)	-	-	-
Big Bend Rd/ Mason-Main/Mill-Cape Rock Dr.	58,642	-	-	-
Bloomfield Rd-Benton Hill-White Oaks	7,399	88,048	-	3,450,000
Walnut St.-Sprigg to West End Blvd	5,973	2,209,041	-	-
Lexington, Rt W/Kingshwy Intersection	(46,355)	(4,882)	-	-
Veterans Memorial Dr.-Ph V	21,173	57,242	2,690,000	-
West End Blvd-Linden to Jefferson Ave.	1,907	(196)	-	-
Broadway/Henderson	82,438	-	-	-
William/Aquamsi/Main Intersection	37,617	(37,065)	-	-
Main Street Overlay	8,181	-	-	-
Safe Routes to Schools-Sidewalk Gap Program	365,117	163,678	-	-
West End-Rose to New Madrid	-	-	552,500	-
Sprigg Street Intersection Improvements	-	-	200,000	-
Sloan Creek Bridge	-	-	-	1,700,000
Lexington to Sherwood to W. Cape Rock	-	-	-	900,000
Asphalt Overlay Program	-	-	-	700,000
Upgrade Street Lights to LED Bulbs	-	-	-	115,000
Neighborhood Street Repair	-	-	-	2,000,000
	<hr/>	<hr/>	<hr/>	<hr/>
Total	<u>\$ 1,140,039</u>	<u>\$ 3,604,619</u>	<u>\$ 5,177,500</u>	<u>\$ 10,090,000</u>
TOTAL CAPITAL PROJECTS	<u>\$ 9,780,536</u>	<u>\$ 9,409,086</u>	<u>\$ 18,963,464</u>	<u>\$ 29,751,300</u>

AUTHORIZED POSITIONS SUMMARY  
Full Time Equivalents (FTE's)

	Actual 2010-11	Actual 2011-12	Actual 2012-13	Actual 2013-14	Actual 2014-15	Actual 2015-16	Proposed 2016-17
<u>Administrative</u>							
City Manager	3.34	3.34	3.35	3.35	3.40	3.40	4.40
City Attorney	3.38	3.38	3.38	3.38	3.50	3.50	3.50
Human Resources	3.33	2.83	3.30	3.30	3.50	3.50	3.50
Finance	7.38	7.38	7.43	7.43	6.88	6.88	6.88
Facility Maintenance	3.00	3.00	3.00	3.00	3.00	3.00	3.00
Municipal Court	5.00	5.00	5.00	5.00	5.00	5.00	5.00
Public Awareness	1.50	1.50	2.00	2.00	2.15	2.15	2.15
TOTAL	26.93	26.43	27.46	27.46	27.43	27.43	28.43
<u>Development Services</u>							
Planning	6.34	6.50	6.30	6.30	4.30	4.30	4.33
Inspection	6.96	6.93	8.30	7.30	7.30	8.30	8.33
Engineering	16.59	16.26	16.32	16.32	17.05	17.02	17.05
<u>Airport</u>							
Operations	8.17	8.72	8.62	8.62	8.66	8.66	9.02
FBO Operations	6.60	6.60	6.60	6.60	6.60	6.60	6.99
Airport Total	14.77	15.32	15.22	15.22	15.26	15.26	16.01
TOTAL	44.66	45.01	46.14	45.14	43.91	44.88	45.72
<u>Parks and Recreation</u>							
Park Maintenance	22.77	23.12	23.29	23.29	23.56	24.25	24.25
Cemetery	4.35	4.39	4.07	3.98	3.98	3.98	3.98
Arena Building Maintenance	3.92	3.92	3.92	3.93	3.93	3.93	3.90
Central Pool	7.12	9.15	9.19	9.23	9.23	9.26	9.26
Capaha Pool	3.62	0.00	0.00	0.00	0.00	0.00	0.00
Family Aquatic Center	13.97	15.30	16.76	15.97	17.02	17.14	17.75
Recreation	12.04	12.27	11.85	11.59	11.31	11.33	11.42
Osage Park	9.54	9.76	10.78	11.49	11.70	11.67	12.48
Shawnee Park Comm. Ctr.	4.83	6.79	6.58	6.09	5.38	5.13	4.85
Golf Course	11.40	12.08	11.29	11.67	11.45	10.95	11.06
Softball Complex	14.27	15.52	18.49	17.83	17.64	17.56	17.93
TOTAL	107.83	112.30	116.22	115.07	115.20	115.20	116.88
<u>Public Safety</u>							
Health	3.52	3.52	3.52	3.52	3.52	3.52	3.50
Police	87.50	89.50	89.50	91.00	104.46	109.46	112.44
Fire	77.96	77.96	77.96	78.96	65.00	65.00	65.00
TOTAL	168.98	170.98	170.98	173.48	172.98	177.98	180.94
<u>Internal Service</u>							
Information Technology	2.50	2.50	3.50	3.50	3.65	3.65	3.65
Fleet	12.58	12.58	12.58	12.45	12.45	12.45	12.45
TOTAL	15.08	15.08	16.08	15.95	16.10	16.10	16.10

**AUTHORIZED POSITIONS SUMMARY**  
Full Time Equivalents (FTE's)

	<u>Actual 2010-11</u>	<u>Proposed 2011-12</u>	<u>Actual 2012-13</u>	<u>Actual 2013-14</u>	<u>Actual 2014-15</u>	<u>Actual 2015-16</u>	<u>Proposed 2016-17</u>
<b>Public Works</b>							
Street	22.92	22.92	22.92	22.80	22.80	22.81	22.81
Sewer							
Stormwater	6.94	6.94	6.94	6.88	6.88	6.38	6.38
Main Street Levees	0.84	0.84	0.84	0.84	0.84	0.84	0.84
Sludge	3.00	3.00	3.00	3.00	3.00	3.00	3.00
Wastewater Operations	11.98	11.98	11.70	11.92	11.92	11.92	11.92
Line Maintenance	9.19	9.19	13.18	13.18	13.18	13.18	13.18
Sewer Total	<u>31.95</u>	<u>31.95</u>	<u>35.66</u>	<u>35.82</u>	<u>35.82</u>	<u>35.32</u>	<u>35.32</u>
Water	2.96	5.73	5.72	5.72	5.72	5.72	5.72
Solid Waste							
Transfer Station	2.50	3.50	3.50	3.38	3.38	3.38	3.38
Residential	14.35	13.35	13.34	13.09	13.09	13.09	12.09
Commercial							
Landfill							
Recycling	6.88	6.88	6.88	6.63	6.63	6.63	6.63
Solid Waste Total	<u>23.73</u>	<u>23.73</u>	<u>23.72</u>	<u>23.10</u>	<u>23.10</u>	<u>23.10</u>	<u>22.10</u>
<b>TOTAL</b>	<u>81.56</u>	<u>84.33</u>	<u>88.02</u>	<u>87.44</u>	<u>87.44</u>	<u>86.95</u>	<u>85.95</u>
<b>TOTAL FTE'S</b>	<u>445.04</u>	<u>454.13</u>	<u>464.90</u>	<u>464.54</u>	<u>463.06</u>	<u>468.54</u>	<u>474.02</u>

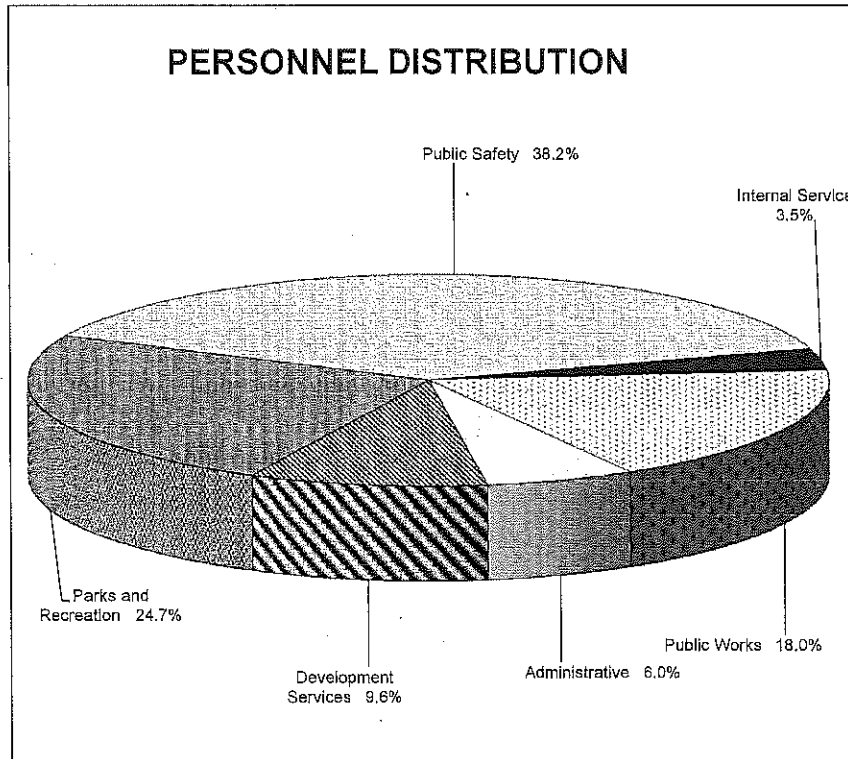



---

THIS PAGE INTENTIONALLY LEFT BLANK

---

## GRADE/SALARY RANGE SCHEDULE

<u>Grade</u>	<u>Minimum</u>	<u>Midpoint</u>	<u>Maximum</u>
X	90,582	113,939	137,296
W	81,765	103,210	123,926
V	74,339	93,475	112,653
U	67,330	84,698	102,066
T	61,006	76,752	92,456
S	55,266	69,514	83,762
R	50,066	63,003	75,899
Q	45,344	57,054	68,744
P	41,080	51,688	62,275
O	39,125	49,213	59,301
N	37,232	46,842	56,430
M	35,422	44,574	53,706
L	33,717	42,432	51,126
K	32,094	40,373	48,651
J	30,555	38,438	46,301
I	29,078	36,566	44,075
H	27,664	34,819	41,954
G	26,354	33,155	39,936
F	25,085	31,533	38,022
E	23,858	30,014	36,171
D	22,714	28,579	33,445
C	21,632	27,206	32,781
B	20,592	25,875	31,179
A	19,269	24,236	29,203
<b>Public Safety</b>			
LL	78,374	98,571	118,768
KK	70,990	89,294	107,578
JJ	64,314	80,870	97,448
II	58,240	73,266	88,292
HH	52,765	66,394	79,993
GG	47,786	60,162	72,480
FF	43,331	54,484	65,666
EE	41,234	51,863	62,592
DD	39,254	49,358	59,493
CC	37,332	46,971	56,580
BB	35,526	44,728	53,785
AA	33,837	42,544	51,280

TAX RATE ANALYSIS\*

Fiscal Year	General Fund	Library Fund	Health Fund	65 Airport	Parks & Recreation	1984 Bldg. Bonds	Total Levy	Business District
1963-64	0.8700	0.1300	0.0700	0.06	0.17		1.3000	
1964-65	0.8700	0.1400	0.0600	0.05	0.17		1.2900	
1965-66	0.8700	0.2000	0.0600	0.19	0.17		1.4900	
1966-67	0.8700	0.2000	0.0600	0.19	0.17		1.4900	
1967-68	0.8700	0.2000	0.0600	0.19	0.13		1.4500	
1968-69	0.9600	0.2000	0.0600	0.19			1.4100	
1969-70	0.9600	0.2000	0.0600	0.19			1.4100	
1970-71	0.5000	0.2000	0.0600	0.19			0.9500	
1971-72	0.5000	0.2000	0.0600	0.09			0.8500	
1972-73	0.5000	0.2000	0.0600	0.09			0.8500	
1973-74	0.5000	0.2000	0.0600	0.08			0.8400	
1974-75	0.4400	0.1800	0.0500	0.07			0.7400	
1975-76	0.4400	0.2000	0.0500	0.07			0.7600	
1976-77	0.4300	0.2000	0.0600	0.05			0.7400	
1977-78	0.4200	0.2000	0.0700	0.05			0.7400	
1978-79	0.4200	0.2000	0.0700	0.05			0.7400	
1979-80	0.4200	0.2000	0.0700	0.05			0.7400	
1980-81	0.4200	0.2000	0.0700	0.05			0.7400	
1981-82	0.4200	0.2000	0.0500	0.05			0.7200	
1982-83	0.4200	0.2000	0.0500	0.05			0.7200	
1983-84	0.4200	0.2000	0.0500	0.05			0.7200	
1984-85	0.4200	0.2000	0.0500	0.05			0.7200	0.8500
1985-86	0.3000	0.1400	0.0400				0.4800	0.8500
1986-87	0.3000	0.1400	0.0400			0.10	0.5800	0.8500
1987-88	0.3000	0.1400	0.0400			0.10	0.5800	0.8500
1988-89	0.3000	0.1400	0.0400			0.10	0.5800	0.8500
1989-90	0.3000	0.1400	0.0400			0.10	0.5800	0.7700
1990-91	0.3000	0.1400	0.0400			0.10	0.5800	0.7700
1991-92	0.3000	0.1400	0.0400			0.10	0.5800	0.8000
1992-93	0.3100	0.1500	0.0400			0.10	0.6000	0.8000
1993-94	0.3200	0.1600	0.0500			0.10	0.6300	0.8000
1994-95	0.3200	0.1600	0.0500			0.10	0.6300	0.8000
1995-96	0.3200	0.1600	0.0500			0.10	0.6300	0.8000
1996-97	0.3300	0.1700	0.0600			0.10	0.6600	0.8000
1997-98	0.3200	0.1700	0.0600			0.10	0.6500	0.7900
1998-99	0.3200	0.1700	0.0600			0.10	0.6500	0.7900
1999-00	0.3200	0.1700	0.0600			0.10	0.6500	0.7900
2000-01	0.3200	0.1700	0.0600			0.10	0.6500	0.7900
2001-02	0.3128	0.1664	0.0586			0.10	0.6378	0.7838
2002-03	0.3135	0.1665	0.0587			0.10	0.6387	0.7793
2003-04	0.3135	0.1665	0.0587			0.10	0.6387	0.7605
2004-05	0.3135	0.1665	0.0587				0.5387	0.7576
2005-06	0.3135	0.1665	0.0587				0.5387	0.7576
2006-07	0.3135	0.1665	0.0587				0.5387	0.7576
2007-08	0.2991	0.3090	0.0560				0.6641	0.6763
2008-09	0.3030	0.3118	0.0567				0.6715	0.6763
2009-10	0.3004	0.3095	0.0562				0.6661	0.6708
2010-11	0.3018	0.3112	0.0565				0.6695	0.6708
2011-12	0.3018	0.3112	0.0565				0.6695	0.6708
2012-13	0.3027	0.3132	0.0567				0.6726	0.6734
2013-14	0.3027	0.3132	0.0567				0.6726	0.6738
2014-15	0.3027	0.3132	0.0567				0.6726	0.6869
2015-16	0.3027	0.3132	0.0567				0.6726	0.6866

\* All tax rates are presented per \$100 of assessed valuation.

ASSESSED VALUE OF TAXABLE PROPERTY

Fiscal Year	Real Estate	Personal Property	Merchants & Manufacturing	R. R. & Utilities	Total	Percent of Change
1964-65	\$32,223,860	\$6,202,220	\$3,505,020	\$1,392,456	\$43,323,556	
1965-66	34,412,340	6,649,080	3,640,340	1,505,642	46,207,402	6.7%
1966-67	35,604,340	7,332,440	3,715,960	1,753,515	48,406,255	4.8%
1967-68	38,355,900	8,082,200	3,832,540	2,031,867	52,302,507	8.0%
1968-69	42,186,000	8,237,220	4,198,580	2,224,729	56,846,529	8.7%
1969-70	43,981,400	8,668,680	4,102,600	2,441,012	59,193,692	4.1%
1970-71	45,439,880	8,863,100	4,274,420	2,626,754	61,204,154	3.4%
1971-72	47,000,480	9,786,720	4,345,800	2,783,860	63,916,860	4.4%
1972-73	50,059,300	9,764,480	4,619,500	2,930,205	67,373,485	5.4%
1973-74	54,712,920	10,686,700	5,286,160	3,110,970	73,796,750	9.5%
1974-75	63,400,200	11,756,920	5,874,980	3,474,335	84,506,435	14.5%
1975-76	65,330,200	11,923,720	6,057,040	4,068,333	87,379,293	3.4%
1976-77	68,883,290	11,810,410	6,305,540	4,235,363	91,234,603	4.4%
1977-78	73,046,700	10,338,290	6,491,940	4,340,871	94,217,801	3.3%
1978-79	78,801,900	12,395,315	6,679,400	5,006,308	102,882,923	9.2%
1979-80	80,342,400	13,123,035	6,684,900	4,880,684	105,031,019	2.1%
1980-81	84,762,810	13,660,940	6,651,520	5,412,522	110,487,792	5.2%
1981-82	98,001,550	13,749,508	6,764,940	5,330,614	123,846,612	12.1%
1982-83	98,615,210	13,389,800	12,915,080	5,421,885	130,341,975	5.2%
1983-84	100,419,370	14,837,940	12,608,280	4,198,382	132,063,972	1.3%
1984-85	99,992,640	13,586,410	13,048,370	13,844,701	140,472,121	6.4%
1985-86	156,607,540	28,628,085		19,026,515	204,262,140	45.4%
1986-87	161,046,740	29,644,440		20,464,762	211,155,942	3.4%
1987-88	165,181,180	29,852,921		20,611,933	215,646,034	2.1%
1988-89	169,915,310	30,499,772		20,331,289	220,746,371	2.4%
1989-90	177,974,550	32,833,840		20,697,281	231,505,671	4.9%
1990-91	181,481,140	32,995,384		20,683,803	235,160,327	1.6%
1991-92	184,638,910	40,378,970		21,491,906	246,509,786	4.8%
1992-93	188,852,960	42,109,675		22,146,745	253,109,380	2.7%
1993-94	195,809,200	45,126,875		17,950,900	258,886,975	2.3%
1994-95	203,600,210	51,733,340		19,113,775	274,447,325	6.0%
1995-96	208,809,260	61,421,730		18,527,925	288,758,915	5.2%
1996-97	215,300,380	69,259,255		19,044,414	303,604,049	5.1%
1997-98	245,894,550	72,237,580		19,406,348	337,538,478	11.2%
1998-99	251,356,660	74,549,645		19,905,580	345,811,885	2.5%
1999-00	260,802,360	77,883,292		20,345,362	359,031,014	3.8%
2000-01	269,016,020	85,006,163		21,291,449	375,313,632	4.5%
2001-02	296,023,850	87,066,979		22,577,736	405,668,565	8.1%
2002-03	302,459,240	86,673,333		21,998,931	411,131,504	1.3%
2003-04	314,074,280	82,030,473		21,820,611	417,925,364	1.7%
2004-05	321,044,100	80,569,040		23,284,355	424,897,495	1.7%
2005-06	346,656,300	85,331,600		15,302,627	447,290,527	5.3%
2006-07	361,998,920	94,755,320		15,006,408	471,760,648	5.5%
2007-08	408,385,280	97,850,863		15,766,380	522,002,523	10.6%
2008-09	421,542,710	90,205,672		15,241,138	526,989,520	1.0%
2009-10	432,056,440	90,443,151		16,382,003	538,881,594	2.3%
2010-11	436,383,490	88,756,143		17,016,310	542,155,943	0.6%
2011-12	441,787,760	86,786,204		18,075,415	546,649,379	0.8%
2012-13	444,515,940	89,254,739		18,277,472	552,048,151	1.0%
2013-14	464,088,030	104,466,758		18,422,026	586,976,814	6.3%
2014-15	473,052,490	109,377,874		19,401,222	601,831,586	2.5%
2015-16	478,128,650	118,311,608		20,657,421	617,097,679	2.5%
				Average Change		5.5%
				5 Year Average Change		2.6%

# What Does a City Property Owner Pay?

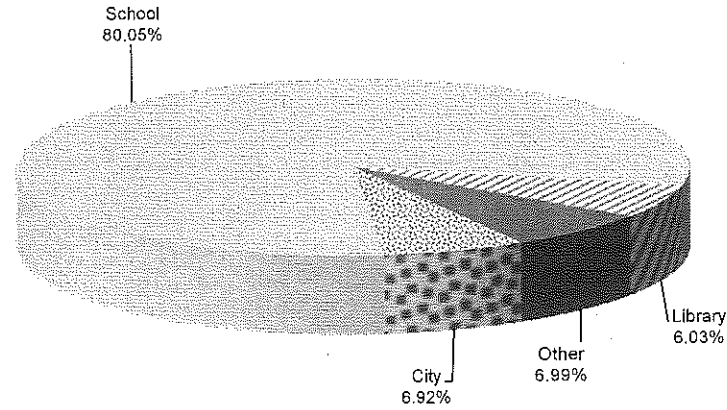

Year	City	Road/Bridge	School	Library	Other	Total
1984	0.5200	0.3500	3.3200	0.2000	0.2300	4.6200
1985	0.3400	0.2500	2.3400	0.1400	0.1700	3.2400
1986	0.4400	0.2500	2.3600	0.1400	0.2700	3.4600
1987	0.4400	0.2500	2.4600	0.1400	0.2700	3.5600
1988	0.4400	0.2500	2.9200	0.1400	0.2700	4.0200
1989	0.4400	0.2500	2.8400	0.1400	0.2700	3.9400
1990	0.4400	0.2500	2.8300	0.1400	0.2700	3.9300
1991	0.4400	0.2600	2.8500	0.1400	0.3200	4.0100
1992	0.4500	0.2600	2.8700	0.1500	0.3200	4.0500
1993	0.4700	0.2700	2.8700	0.1600	0.3200	4.0900
1994	0.4700	0.2700	2.8600	0.1600	0.3200	4.0800
1995	0.4700	0.2800	2.8800	0.1600	0.3400	4.1300
1996	0.4900	0.2800	2.8800	0.1700	0.3400	4.1600
1997	0.4800	0.2700	3.3800	0.1700	0.3400	4.6400
1998	0.4800	0.2700	3.4100	0.1700	0.3400	4.6700
1999	0.4800	0.2700	3.4100	0.1700	0.3400	4.6700
2000	0.4800	0.2700	3.4100	0.1700	0.3400	4.6700
2001	0.4714	0.2639	3.9900	0.1664	0.3345	5.2262
2002	0.4722	0.2681	3.9900	0.1665	0.3410	5.2378
2003	0.4722	0.2681	3.9900	0.1665	0.3410	5.2378
2004	0.3722	0.2681	4.1600	0.1665	0.3410	5.3078
2005	0.3722	0.2681	4.1600	0.1665	0.3410	5.3078
2006	0.3722	0.2681	4.1567	0.1665	0.3410	5.3045
2007	0.3551	0.0000	4.0284	0.3090	0.3287	5.0212
2008	0.3597	0.0000	4.1567	0.3118	0.3299	5.1581
2009	0.3566	0.0000	4.1567	0.3095	0.3275	5.1503
2010	0.3583	0.0000	4.1567	0.3112	0.3275	5.1537
2011	0.3583	0.0000	4.1567	0.3112	0.2890	5.1152
2012	0.3594	0.0000	4.1567	0.3132	0.3662	5.1955
2013	0.3594	0.0000	4.1567	0.3132	0.3729	5.2022
2014	0.3594	0.0000	4.1567	0.3132	0.3891	5.2184
2015	0.3594	0.0000	4.1567	0.3132	0.3631	5.1924

The reduction in tax rates in 1985 is a direct result of reassessment. At the present, the County assesses residential property at 19% of its actual value (as determined by Missouri statutes.) In 2015, the City's tax levy was .3594 per \$100 of assessed valuation. An individual who owns a home with an actual value of \$100,000 will pay the following tax to the City:

$$\begin{aligned} \$100,000 \times 19\% &= \$19,000 \text{ Assessed Valuation} \\ \$19,000/100 &= 190 \times .3594 = \$68.29 \text{ (City Property Tax)} \end{aligned}$$

CITY OF CAPE GIRARDEAU  
Debt Statement

	Outstanding Principal Balance	Debt Service Reserves	Net Debt Outstanding	Authorized By
<b>State Revolving Fund Bonds</b>				
1995D Sewer SRF Bonds	259,535		259,535	Public Vote
1996D Sewer SRF Bonds	2,830,000		2,830,000	Public Vote
2000B Sewer SRF Bonds	6,010,000		6,010,000	Public Vote
2012 SRF Sewer Revenue Direct Loan	29,744,000		29,744,000	Public Vote
2013A SRF Sewer Revenue Direct Loan	3,116,000		3,116,000	Public Vote
2013B SRF Sewer Revenue Direct Loan	<u>34,277,000</u>		<u>34,277,000</u>	Public Vote
	76,236,535		76,236,535	
<b>Revenue Bonds</b>				
2010 MO Waterworks System Revenue Bonds	760,600		760,600	Public Vote
2012 Water System Refunding Revenue Bonds	<u>11,665,000</u>		<u>11,665,000</u>	Public Vote
	12,425,600		12,425,600	
<b>Annual Appropriation Debt</b>				
2010 Special Obligation Bonds	385,000		385,000	Council Election
2013 Direct Loan	3,619,901		3,619,901	Council Election
2015A Special Obligation Bonds	9,185,000		9,185,000	Public Vote
2015B Special Obligation Bonds	985,000		985,000	Public Vote
2016 Special Obligation Bonds	<u>27,350,000</u>		<u>27,350,000</u>	Public Vote
	41,524,901		41,524,901	
 <b>TOTAL CURRENT OUTSTANDING OBLIGATIONS</b>	 <u><u>\$130,187,036</u></u>		 <u><u>\$130,187,036</u></u>	

Computation of Legal Debt Margin

Assessed Value	<u>\$617,097,679</u>
Legal Debt Margin: Legal Debt Margin -Debt limitation - 20 percent of total assessed value	<u>\$123,419,536</u> 1)

1) No General Obligation debt currently outstanding.

CITY OF CAPE GIRARDEAU  
Total Debt Service Outstanding By Bond Type  
July 1, 2016

	State Revolving Fund Bonds	Revenue Bonds	Leasehold Revenue Bonds	Special Obligation Bonds	TOTAL
06-30-17	7,488,917	1,432,731	2,546,553	5,107,756	16,575,958
06-30-18	6,480,257	1,430,631	2,547,353	5,669,904	16,128,146
06-30-19	7,376,356	1,433,081	1,719,435	3,648,504	14,177,377
06-30-20	6,331,451	1,429,931	59,108	2,233,178	10,053,669
06-30-21	6,197,350	1,430,131	59,357	2,399,778	10,086,617
06-30-22	4,523,717	1,430,781	59,792	2,517,254	8,531,544
06-30-23	4,522,867	1,430,831	60,208	2,601,478	8,615,384
06-30-24	4,521,103	1,430,281	60,607	2,623,128	8,635,119
06-30-25	4,519,400	1,428,250	60,987	2,651,616	8,660,253
06-30-26	4,518,710	969,688	61,450	2,251,616	7,801,463
06-30-27	4,517,961	969,375	61,892	2,267,516	7,816,744
06-30-28	4,514,117	972,250	62,416	2,285,336	7,834,119
06-30-29	4,514,164	973,069	62,818	2,312,742	7,862,793
06-30-30	4,512,009	972,800	63,301	2,330,880	7,878,990
06-30-31	4,509,613	968,200		1,714,884	7,192,697
06-30-32	4,506,941	972,400		892,034	6,371,375
06-30-33	4,505,945			897,060	5,403,005
06-30-34	4,503,529			901,134	5,404,663
06-30-35	2,245,715			794,260	3,039,975
06-30-36				474,954	474,954
	<u>\$94,810,123</u>	<u>\$19,674,431</u>	<u>\$7,485,277</u>	<u>\$46,575,012</u>	<u>\$168,544,843</u>

CITY OF CAPE GIRARDEAU  
 Total Debt Service Outstanding by Repayment Source  
 July 1, 2016

	<u>User Fees</u>	<u>Taxes</u>	<u>General Fund Revenues</u>	<u>State Subsidy (SRF)</u>	<u>Debt Reserves</u>	<u>Total</u>
06-30-17	5,989,913	10,231,858	18,912	334,487	788	16,575,958
06-30-18	5,996,289	8,860,807	18,912	266,349	985,788	16,128,145
06-30-19	1,260,837	12,731,085		185,453		14,177,376
06-30-20	1,259,654	8,700,075		93,939		10,053,669
06-30-21	1,261,478	8,793,953		31,185		10,086,617
06-30-22	1,263,813	7,267,730				8,531,543
06-30-23	1,260,404	7,354,980				8,615,384
06-30-24	1,261,378	7,373,741				8,635,119
06-30-25	1,260,327	7,399,925				8,660,252
06-30-26	1,262,278	6,539,185				7,801,463
06-30-27	1,262,307	6,554,436				7,816,743
06-30-28	1,265,456	6,568,663				7,834,119
06-30-29	1,266,052	6,596,741				7,862,793
06-30-30	1,265,254	6,613,735				7,878,989
06-30-31	1,200,988	5,991,710				7,192,697
06-30-32	1,203,438	5,167,938				6,371,376
06-30-33	228,863	5,174,142				5,403,005
06-30-34	226,513	5,178,150				5,404,663
06-30-35	113,988	2,925,987				3,039,975
06-30-35	-	474,960				474,960
	<u>30,109,228</u>	<u>136,499,802</u>	<u>37,824</u>	<u>911,413</u>	<u>986,576</u>	<u>168,544,843</u>



DEBT SERVICE  
 Schedule of Requirements  
 STATE REVOLVING FUND  
 1995D Issue (1)

Period Ending	Interest Rate	Principal Due	Interest Due (2)	Total Payments
07-01-16 01-01-17	6.25%	<u>259,535</u>	<u>716,762</u>	<u>976,298</u>
		\$259,535	\$716,762	\$976,298

Weighted Average Life= 6 Months

- (1) Capital Appreciation Bonds, interest paid at maturity.  
 (2) Includes .5% administrative fee

DEBT SERVICE  
Schedule of Requirements  
STATE REVOLVING FUND  
Issue 1996 (1)

Period Ending	Interest Rate	Principal Due	Interest Due (2)	Total Payments
07-01-16			77,725	77,725
01-01-17	5.90%	920,000	86,875	1,006,875
07-01-17			52,353	52,353
01-01-18	5.90%	945,000	56,903	1,001,903
07-01-18			26,353	26,353
01-01-19	5.90%	<u>965,000</u>	<u>21,178</u>	<u>986,178</u>
	5.90%	\$2,830,000	\$321,387	\$3,151,387

Weighted Average Life = 18.191 Months

(1) 70% of gross interest is paid by state subsidy

(2) Gross interest before subsidy. January payments includes .5% administrative fee.

DEBT SERVICE  
Schedule of Requirements  
STATE REVOLVING FUND  
2000B Issue (1)

Period Ending	Interest Rate	Principal Due	Interest Due (2)	Total Payments
07/01/16	5.625%	555,000	193,873	748,873
01/01/17			148,214	148,214
07/01/17	5.300%	590,000	175,489	765,489
01/01/18			132,579	132,579
07/01/18	5.400%	1,590,000	156,904	1,746,904
01/01/19			89,649	89,649
07/01/19	5.450%	1,655,000	106,024	1,761,024
01/01/20			44,550	44,550
07/01/20	5.500%	1,620,000	52,650	1,672,650
	5.455%	\$6,010,000	\$1,099,932	\$7,109,932

Weighted Average Life = 30.4 Months

- (1) 70% of gross interest is paid by state subsidy
- (2) Gross interest before subsidy. January payments includes .5% administrative fee.

DEBT SERVICE  
Schedule of Requirements  
STATE REVOLVING FUND DIRECT LOAN  
Issue 2012

Period Ending	Interest Rate	Principal Due	Interest Due (1)	Total Payments
07-01-16	1.430%	640,000	361,390	1,001,390
01-01-17	1.430%	648,000	353,614	1,001,614
07-01-17	1.430%	655,000	345,740	1,000,740
01-01-18	1.430%	664,000	337,782	1,001,782
07-01-18	1.430%	672,000	329,715	1,001,715
01-01-19	1.430%	680,000	321,550	1,001,550
07-01-19	1.430%	688,000	313,288	1,001,288
01-01-20	1.430%	697,000	304,929	1,001,929
07-01-20	1.430%	705,000	296,460	1,001,460
01-01-21	1.430%	714,000	287,894	1,001,894
07-01-21	1.430%	723,000	279,219	1,002,219
01-01-22	1.430%	732,000	270,435	1,002,435
07-01-22	1.430%	741,000	261,541	1,002,541
01-01-23	1.430%	750,000	252,538	1,002,538
07-01-23	1.430%	759,000	243,425	1,002,425
01-01-24	1.430%	768,000	234,203	1,002,203
07-01-24	1.430%	778,000	224,872	1,002,872
01-01-25	1.430%	787,000	215,420	1,002,420
07-01-25	1.430%	797,000	205,857	1,002,857
01-01-26	1.430%	807,000	196,174	1,003,174
07-01-26	1.430%	817,000	186,369	1,003,369
01-01-27	1.430%	827,000	176,442	1,003,442
07-01-27	1.430%	837,000	166,394	1,003,394
01-01-28	1.430%	847,000	156,225	1,003,225
07-01-28	1.430%	858,000	145,934	1,003,934
01-01-29	1.430%	868,000	135,509	1,003,509
07-01-29	1.430%	879,000	124,963	1,003,963
01-01-30	1.430%	890,000	114,283	1,004,283
07-01-30	1.430%	901,000	103,469	1,004,469
01-01-31	1.430%	912,000	92,522	1,004,522
07-01-31	1.430%	923,000	81,441	1,004,441
01-01-32	1.430%	934,000	70,227	1,004,227
07-01-32	1.430%	946,000	58,879	1,004,879
01-01-33	1.430%	958,000	47,385	1,005,385
07-01-33	1.430%	969,000	35,745	1,004,745
01-01-34	1.430%	981,000	23,972	1,004,972
07-01-34	1.430%	992,000	12,053	1,004,053
	1.430%	\$29,744,000	\$7,367,857	\$37,111,857

Weighted Average Life = 116.33 Months

1) Includes 1% Administrative fee

DEBT SERVICE  
Schedule of Requirements  
STATE REVOLVING FUND DIRECT LOAN  
Issue 2013A

Period Ending	Interest Rate	Principal Due	Interest Due (1)	Total Payments
07-01-16	1.390%	68,000	37,236	105,236
01-01-17	1.390%	69,000	36,424	105,424
07-01-17	1.390%	70,000	35,599	105,599
01-01-18	1.390%	70,000	34,763	104,763
07-01-18	1.390%	71,000	33,926	104,926
01-01-19	1.390%	72,000	33,078	105,078
07-01-19	1.390%	73,000	32,217	105,217
01-01-20	1.390%	74,000	31,345	105,345
07-01-20	1.390%	75,000	30,461	105,461
01-01-21	1.390%	75,000	29,564	104,564
07-01-21	1.390%	76,000	28,668	104,668
01-01-22	1.390%	77,000	27,760	104,760
07-01-22	1.390%	78,000	26,840	104,840
01-01-23	1.390%	79,000	25,908	104,908
07-01-23	1.390%	80,000	24,964	104,964
01-01-24	1.390%	81,000	24,008	105,008
07-01-24	1.390%	82,000	23,040	105,040
01-01-25	1.390%	83,000	22,060	105,060
07-01-25	1.390%	84,000	21,068	105,068
01-01-26	1.390%	85,000	20,064	105,064
07-01-26	1.390%	86,000	19,048	105,048
01-01-27	1.390%	87,000	18,021	105,021
07-01-27	1.390%	88,000	16,981	104,981
01-01-28	1.390%	89,000	15,929	104,929
07-01-28	1.390%	90,000	14,866	104,866
01-01-29	1.390%	91,000	13,790	104,790
07-01-29	1.390%	92,000	12,703	104,703
01-01-30	1.390%	93,000	11,603	104,603
07-01-30	1.390%	94,000	10,492	104,492
01-01-31	1.390%	95,000	9,369	104,369
07-01-31	1.390%	96,000	8,234	104,234
01-01-32	1.390%	97,000	7,086	104,086
07-01-32	1.390%	98,000	5,927	103,927
01-01-33	1.390%	99,000	4,756	103,756
07-01-33	1.390%	100,000	3,573	103,573
01-01-34	1.390%	102,000	2,378	104,378
07-01-34	1.390%	97,000	1,159	98,159
	1.390%	\$3,116,000	\$754,905	\$3,870,905

Weighted Average Life = 115.64 Months

1) Includes 1% Administrative fee

DEBT SERVICE  
Schedule of Requirements  
STATE REVOLVING FUND DIRECT LOAN  
Issue 2013B

Period Ending	Interest Rate	Principal Due (2)	Interest Due (1)	Total Payments
07-01-16	1.390%	749,000	409,610	1,158,610
01-01-17	1.390%	758,000	400,660	1,158,660
07-01-17	1.390%	766,000	391,602	1,157,602
01-01-18	1.390%	775,000	382,448	1,157,448
07-01-18	1.390%	784,000	373,187	1,157,187
01-01-19	1.390%	793,000	363,818	1,156,818
07-01-19	1.390%	802,000	354,341	1,156,341
01-01-20	1.390%	811,000	344,758	1,155,758
07-01-20	1.390%	821,000	335,066	1,156,066
01-01-21	1.390%	830,000	325,255	1,155,255
07-01-21	1.390%	840,000	315,337	1,155,337
01-01-22	1.390%	849,000	305,299	1,154,299
07-01-22	1.390%	859,000	295,153	1,154,153
01-01-23	1.390%	869,000	284,888	1,153,888
07-01-23	1.390%	879,000	274,503	1,153,503
01-01-24	1.390%	889,000	263,999	1,152,999
07-01-24	1.390%	899,000	253,376	1,152,376
01-01-25	1.390%	909,000	242,633	1,151,633
07-01-25	1.390%	920,000	231,770	1,151,770
01-01-26	1.390%	930,000	220,776	1,150,776
07-01-26	1.390%	941,000	209,663	1,150,663
01-01-27	1.390%	952,000	198,418	1,150,418
07-01-27	1.390%	962,000	187,041	1,149,041
01-01-28	1.390%	973,000	175,547	1,148,547
07-01-28	1.390%	985,000	163,918	1,148,918
01-01-29	1.390%	996,000	152,147	1,148,147
07-01-29	1.390%	1,007,000	140,245	1,147,245
01-01-30	1.390%	1,019,000	128,212	1,147,212
07-01-30	1.390%	1,030,000	116,035	1,146,035
01-01-31	1.390%	1,042,000	103,726	1,145,726
07-01-31	1.390%	1,054,000	91,274	1,145,274
01-01-32	1.390%	1,066,000	78,679	1,144,679
07-01-32	1.390%	1,078,000	65,940	1,143,940
01-01-33	1.390%	1,091,000	53,058	1,144,058
07-01-33	1.390%	1,103,000	40,021	1,143,021
01-01-34	1.390%	1,116,000	26,840	1,142,840
07-01-34	1.390%	1,130,000	13,504	1,143,504
	1.390%	\$34,277,000	\$8,312,744	\$42,589,744

Weighted Average Life = 121.77 Months

1) Includes 1% Administrative fee

2) Through June 25, 2015 only \$28,374,137 of this loan has been disbursed.

DEBT SERVICE  
Schedule of Requirements  
MISSOURI WATERWORKS SYSTEM REVENUE BONDS  
2010 Issue

Period Ending	Interest Rate	Principal Due	Interest Due	Total Payments
07-01-16	1.490%	23,300	5,666	28,966
01-01-17	1.490%	23,500	5,493	28,993
07-01-17	1.490%	23,800	5,318	29,118
01-01-18	1.490%	24,100	5,141	29,241
07-01-18	1.490%	24,300	4,961	29,261
01-01-19	1.490%	24,600	4,780	29,380
07-01-19	1.490%	24,900	4,597	29,497
01-01-20	1.490%	25,200	4,411	29,611
07-01-20	1.490%	25,400	4,223	29,623
01-01-21	1.490%	25,700	4,034	29,734
07-01-21	1.490%	26,000	3,843	29,843
01-01-22	1.490%	26,300	3,649	29,949
07-01-22	1.490%	26,600	3,453	30,053
01-01-23	1.490%	26,900	3,255	30,155
07-01-23	1.490%	27,200	3,055	30,255
01-01-24	1.490%	27,500	2,852	30,352
07-01-24	1.490%	27,800	2,647	30,447
01-01-25	1.490%	28,100	2,440	30,540
07-01-25	1.490%	28,400	2,231	30,631
01-01-26	1.490%	28,800	2,019	30,819
07-01-26	1.490%	29,100	1,804	30,904
01-01-27	1.490%	29,400	1,588	30,988
07-01-27	1.490%	29,800	1,369	31,169
01-01-28	1.490%	30,100	1,147	31,247
07-01-28	1.490%	30,400	922	31,322
01-01-29	1.490%	30,800	696	31,496
07-01-29	1.490%	31,100	466	31,566
01-01-30	1.490%	31,500	235	31,735
	1.490%	\$760,600	\$86,295	\$846,895

Weighted Average Life= 85.372 Months

DEBT SERVICE  
Schedule of Requirements  
WATER SYSTEM REFUNDING REVENUE BONDS  
Issue 2012

Period Ending	Interest Rate	Principal Due	Interest Due (2)	Total Payments
07-01-16			201,366	201,366
01-01-17	3.000%	570,000	201,366	771,366
07-01-17			192,816	192,816
01-01-18	3.000%	585,000	192,816	777,816
07-01-18			184,041	184,041
01-01-19	3.000%	605,000	184,041	789,041
07-01-19			174,966	174,966
01-01-20	4.000%	620,000	174,966	794,966
07-01-20			162,566	162,566
01-01-21	3.000%	645,000	162,566	807,566
07-01-21			152,891	152,891
01-01-22	3.000%	665,000	152,891	817,891
07-01-22			142,916	142,916
01-01-23	3.000%	685,000	142,916	827,916
07-01-23			132,641	132,641
01-01-24	3.125%	705,000	132,641	837,641
07-01-24			121,625	121,625
01-01-25	3.250%	725,000	121,625	846,625
07-01-25			109,844	109,844
01-01-26	3.375%	750,000	109,844	859,844
07-01-26			97,188	97,188
01-01-27	3.500%	775,000	97,188	872,188
07-01-27			83,625	83,625
01-01-28	3.625%	805,000	83,625	888,625
07-01-28			69,034	69,034
01-01-29	3.625%	835,000	69,034	904,034
07-01-29			53,900	53,900
01-01-30	4.000%	865,000	53,900	918,900
07-01-30			36,600	36,600
01-01-31	4.000%	895,000	36,600	931,600
07-01-31			18,700	18,700
01-01-32	4.000%	935,000	18,700	953,700
	3.617%	\$11,665,000	\$3,869,431	\$15,534,431

Weighted Average Life = 104.32 Months



DEBT SERVICE  
 Schedule of Requirements  
 SPECIAL OBLIGATION REFUNDING AND IMPROVEMENT BONDS  
 2010 Issue

Period Ending	Interest Rate	Principal Due	Interest Due	Total Payments
07-01-16			6,150	6,150
01-01-17	3.000%	185,000	6,150	191,150
07-01-17			3,375	3,375
01-01-18	3.375%	200,000	3,375	203,375
	3.287%	\$385,000	\$19,050	\$404,050

Weighted Average Life= 12.234 Months

DEBT SERVICE  
Schedule of Requirements  
SOUTHEAST MISSOURI STATE UNIVERSITY DIRECT LOAN  
Issue 2013

Period Ending	Interest Rate (1)	Principal Due	Interest Due (1)	Total Payments
02-04-17	2.77%	359,454	100,546	460,000
02-04-18	2.77%	369,686	90,314	460,000
02-04-19	2.77%	379,926	80,074	460,000
02-04-20	2.77%	390,450	69,550	460,000
02-04-21	2.77%	401,104	58,896	460,000
02-04-22	2.77%	412,376	47,624	460,000
02-04-23	2.77%	423,799	36,201	460,000
02-04-24	2.77%	435,538	24,462	460,000
02-04-25	2.77%	447,568	12,432	460,000
	2.770%	\$3,619,901	\$520,099	\$4,140,000

Weighted Average Life = 57.19 Months

- 1) Direct loan included no provision for interest. Imputed interest rate was based on true interest cost of twelve years level debt service on annual appropriate bond as of the date of closing.

DEBT SERVICE  
Schedule of Requirements  
SPECIAL OBLIGATION REFUNDING AND IMPROVEMENT BONDS  
2015A Issue

Period Ending	Interest Rate	Principal Due	Interest Due	Total Payments
12-01-16			132,230	132,230
06-01-17	2.500%	545,000	132,230	677,230
12-01-17			125,418	125,418
06-01-18	2.500%	550,000	125,418	675,418
12-01-18			118,543	118,543
06-01-19	2.500%	565,000	118,543	683,543
12-01-19			111,480	111,480
06-01-20	2.500%	600,000	111,480	711,480
12-01-20			103,980	103,980
06-01-21	2.500%	625,000	103,980	728,980
12-01-21			96,168	96,168
06-01-22	2.500%	655,000	96,168	751,168
12-01-22			87,980	87,980
06-01-23	2.500%	670,000	87,980	757,980
12-01-23			79,605	79,605
06-01-24	2.750%	695,000	79,605	774,605
12-01-24			70,049	70,049
06-01-25	3.000%	720,000	70,049	790,049
12-01-25			59,249	59,249
06-01-26	3.000%	330,000	59,249	389,249
12-01-26			54,299	54,299
06-01-27	3.000%	340,000	54,299	394,299
12-01-27			49,199	49,199
06-01-28	3.125%	355,000	49,199	404,199
12-01-28			43,652	43,652
06-01-29	3.250%	365,000	43,652	408,652
12-01-29			37,721	37,721
06-01-30	3.350%	370,000	37,721	407,721
12-01-30			31,523	31,523
06-01-31	3.375%	360,000	31,523	391,523
12-01-31			25,448	25,448
06-01-32	3.500%	345,000	25,448	370,448
12-01-32			19,411	19,411
06-01-33	3.500%	355,000	19,411	374,411
12-01-33			13,198	13,198
06-01-34	3.500%	365,000	13,198	378,198
12-01-34			6,811	6,811
06-01-35	3.625%	265,000	6,811	271,811
12-01-35			2,008	2,008
06-01-36	3.650%	110,000	2,008	112,008
	3.113%	\$9,185,000	\$2,535,944	\$11,720,944

Weighted Average Life= 105.49 Months

DEBT SERVICE  
 Schedule of Requirements  
 SPECIAL OBLIGATION REFUNDING AND IMPROVEMENT BONDS  
 2015B Issue

Period Ending	Interest Rate	Principal Due	Interest Due	Total Payments
12-01-16			9,850	9,850
06-01-17	2.000%		9,850	9,850
12-01-17			9,850	9,850
06-01-18	2.000%	985,000	9,850	994,850
	2.000%	\$985,000	\$39,400	\$1,024,400

Weighted Average Life= 23 Months

DEBT SERVICE  
Schedule of Requirements  
SPECIAL OBLIGATION REFUNDING AND IMPROVEMENT BONDS  
2016 Issue

Period Ending	Interest Rate	Principal Due	Interest Due	Total Payments
12-01-16			358,587	358,587
06-01-17	2.000%	3,390,000	332,709	3,722,709
12-01-17			298,809	298,809
06-01-18	2.000%	3,060,000	298,809	3,358,809
12-01-18			268,209	268,209
06-01-19	2.000%	2,310,000	268,209	2,578,209
12-01-19			245,109	245,109
06-01-20	2.000%	920,000	245,109	1,165,109
12-01-20			235,909	235,909
06-01-21	2.000%	1,095,000	235,909	1,330,909
12-01-21			224,959	224,959
06-01-22	2.000%	1,220,000	224,959	1,444,959
12-01-22			212,759	212,759
06-01-23	2.000%	1,330,000	212,759	1,542,759
12-01-23			199,459	199,459
06-01-24	2.000%	1,370,000	199,459	1,569,459
12-01-24			185,759	185,759
06-01-25	2.000%	1,420,000	185,759	1,605,759
12-01-25			171,559	171,559
06-01-26	2.000%	1,460,000	171,559	1,631,559
12-01-26			156,959	156,959
06-01-27	2.125%	1,505,000	156,959	1,661,959
12-01-27			140,969	140,969
06-01-28	3.000%	1,550,000	140,969	1,690,969
12-01-28			117,719	117,719
06-01-29	4.000%	1,625,000	117,719	1,742,719
12-01-29			85,219	85,219
06-01-30	4.000%	1,715,000	85,219	1,800,219
12-01-30			50,919	50,919
06-01-31	3.000%	1,190,000	50,919	1,240,919
12-01-31			33,069	33,069
06-01-32	3.000%	430,000	33,069	463,069
12-01-32			26,619	26,619
06-01-33	3.000%	450,000	26,619	476,619
12-01-33			19,869	19,869
06-01-34	3.000%	470,000	19,869	489,869
12-01-34			12,819	12,819
06-01-35	3.000%	490,000	12,819	502,819
12-01-35			5,469	5,469
06-01-36	3.125%	350,000	5,469	355,469
	2.779%	\$27,350,000	\$6,075,618	\$33,425,618

Weighted Average Life= 94.651 Months

## FEE SCHEDULE

*Effective July 1, 2016*

*Fees are non-refundable, unless an application is canceled by the City or the applicant. Upon receipt of written notification of cancelling an application, the applicant will receive a refund of any amount paid which exceeds the cost incurred by the City in processing and reviewing the application to date.*

### APPLICATION FEES

---

#### ADMINISTRATIVE RELIEF - Planning Services Division

---

\$75.00 application fee per section

#### CBD DESIGN STANDARDS APPROVAL - Planning Services Division

---

*No fee*

#### CERTIFICATE OF APPROPRIATENESS - Planning Services Division

---

*No fee*

#### EXCEPTION - Planning Services Division

---

\$75.00 application fee per section

#### LOCAL HISTORIC DISTRICT DESIGNATION - Planning Services Division

---

\$126.00 application fee

#### LOCAL HISTORIC LANDMARK DESIGNATION - Planning Services Division

---

\$126.00 application fee

#### REZONING / SPECIAL USE PERMIT - Planning Services Division

---

\$135.00 application fee + \$80.00 if rezoning to Planned Development (PD)

#### VARIANCE - Planning Services Division

---

\$75.00 application fee per section

#### BOARD OF EXAMINERS - Inspection Services Division

---

\$80.00 application fee

#### BOARD OF APPEALS - Inspection Services Division

---

\$100.00 application fee

### INSPECTION FEES

---

#### INFRASTRUCTURE IMPROVEMENTS / RELOCATIONS / MODIFICATIONS (STREETS, WATER, SANITARY SEWER, AND PUBLIC STORM WATER) - Engineering Division

---

*Actual inspection costs*

## LICENSE FEES

### RESIDENTIAL RENTAL LICENSE - Inspection Services Division

License fee	\$20
License renewal fee	\$20
Inspection fee	\$65 (for compliance inspection or missed inspection)

#### License Renewal Late Fees

\$ 0.50 per day beginning on day 31 and every calendar day thereafter past renewal date

### TRADE LICENSES - Inspection Services Division

Building trade licenses = \$ 35.00 (*renewable annually*)

#### License Renewal Late Fees

\$ 0.50 per day beginning on day 31 and every calendar day thereafter past renewal date

## PERMIT FEES

### BUILDING PERMITS - Inspection Services Division

#### Demolition

\$50.00 (*flat fee*)

#### New Construction and Additions

0 - 1,000 sq ft	=	\$ .125 per sq ft ( <b>\$80.00 minimum</b> )
1,000 sq ft - 2,500 sq ft	=	\$125.00 + \$.125 per sq ft for area over 1,000 sq ft
2,501 sq ft - 10,000 sq ft	=	\$250.00 + \$.125 per sq ft over 2,500 sq ft
Over 10,000 sq ft	=	\$462.50 + \$.125 per sq ft for area over 10,000 sq ft

#### Re-Inspection Fees

\$30.00 per inspection after the first two (2) inspections

#### Remodeling

\$0 - \$3,000	=	\$ 80.00
\$3,001 - \$10,000	=	\$ \$125.00 + \$3.00 each additional \$1,000 (next \$7,000)
\$10,001 - \$50,000	=	\$ \$150.00 + \$2.00 each additional \$1,000 (next \$40,000)
\$50,001 - \$100,000	=	\$ \$200 + \$1.00 each additional \$1,000 (next \$50,000)
Over \$100,000	=	\$ \$250 + \$0.50 each additional \$1,000 (over \$100,000)

#### Signs and Billboards

Sign	=	\$ 45.00
Billboard	=	\$ 50.00

# CITY of CAPE GIRARDEAU

## DEVELOPMENT SERVICES

### Miscellaneous

---

Commercial driveway	=	\$ 75.00
Residential driveway	=	\$ 50.00
Driveway with culvert	=	\$100.00
Fence	=	\$ 45.00
Mobile home re-inspection	=	\$ 30.00
Retaining wall	=	\$ 50.00
Sidewalk	=	\$ 55.00

### ELECTRICAL PERMITS - Inspection Services Division

---

\$ 3.00 per circuit  
\$ 30.00 per service  
**\$30.00 minimum** permit charge

### EXCAVATION - Inspection Services Division

---

Excavation with no pavement cut: \$50.00  
Excavation with pavement cut: \$100.00

### FLOODPLAIN DEVELOPMENT - Engineering Division

---

Development in the floodplain: \$25.00  
Development in the floodway: \$50.00

### MECHANICAL PERMITS - Inspection Services Division

---

\$ 0.20 per 1,000 BTU input of appliances  
\$ 2.00 per 10 feet of pipe or portion thereof  
\$20.00 to move meter  
**\$30.00 minimum** permit charge

### PLUMBING PERMITS - Inspection Services Division

---

\$30.00 **minimum** permit charge + \$2.00 per fixture  
\$30.00 cut wye into sewer main  
\$30.00 septic tank installation

### SANITARY SEWER PERMITS - Inspection Services Division

---

#### Private Sewage Disposal System

---

Single family: \$30.00  
Multifamily, commercial, and industrial: \$50.00

#### Sewer Connection for Parcel Outside the Boundaries of a Sewer District

---

\$250.00 per building served

#### Sewer Main Connection

---

\$500.00 (*flat fee*)

#### Sewer Service if Producing Industrial Wastes

---

Residential or commercial building sewer permit: \$30.00  
Industrial building sewer permit: \$35.00



# CITY of CAPE GIRARDEAU

## DEVELOPMENT SERVICES

### Sewer Tap Fees

¾" water tap	=	\$ 750.00
1"	=	\$1,460.00
1 ½"	=	\$2,640.00
2"	=	\$3,820.00
3"	=	\$9,010.00
4" & larger	=	\$ 0.373 per est. gallon/day of volume for new connector

### WATER PERMITS - Inspection Services Division

#### Water Main Connection

\$500.00 (flat fee)

#### Water Service Installation Fees

¾" service line	=	\$ 635.29
1"	=	\$ 942.96
1 ½"	=	\$1,860.46
2"	=	\$2,467.76
OVER 2"	=	\$2,467.76 DEPOSIT – adjustments to reflect actual cost will be made after completion of work

### PLAN REVIEW FEES

Due at the time plans are submitted for review.

### COMMERCIAL BUILDING - Inspection Services Division

New construction & additions: \$80.00 + \$.04 per sq ft

Remodels: \$ 80.00 + 0.2% of the cost of construction

### RESIDENTIAL BUILDING – Inspection Services Division

New construction & additions: \$80.00 + \$ 0.04 per sq ft

### SUBDIVISION PLAT - Planning Services Division

Single-family or two-family residential: \$20.00 per lot (**\$100.00 minimum**) + recording fee

Multifamily residential: \$20 per dwelling unit (**\$100.00 minimum**) + recording fee

Non-residential: \$20 per acre (**\$100.00 minimum**) + recording fee

### Recording Fees\*

18" x 24"	=	\$44.00
24" x 36"	=	\$69.00

\* Recording fees are set by the Cape Girardeau County Recorder of Deeds Office and are subject to change.

### STORMWATER MANAGEMENT (INCLUDING FILL / GRADING) - Engineering Division

Grading/fill and stormwater permits: \$100.00